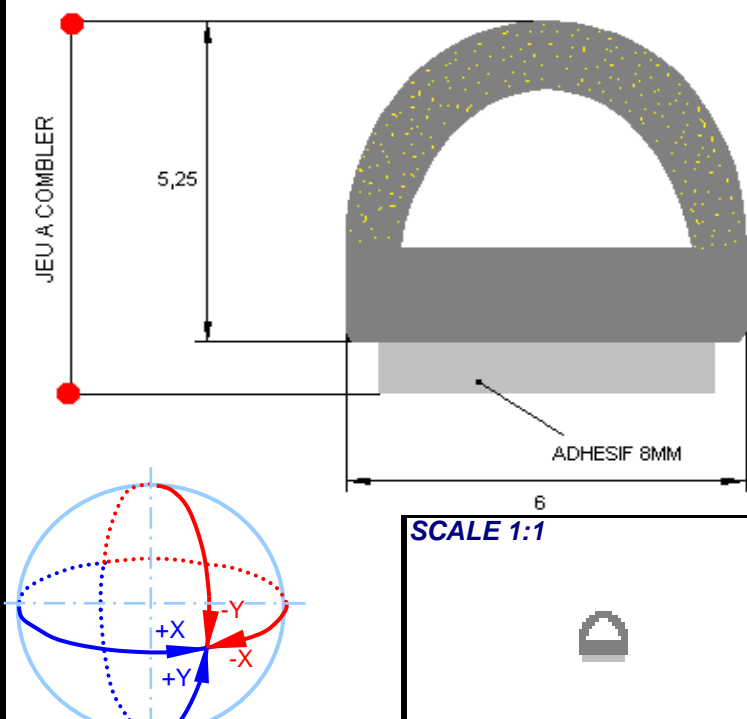

	PRODUCT NAME MF05 ITEM NUMBER 9J242	
PRODUCT PICTURE 		

PRODUCT DESCRIPTION

Cellular Rubber : gives flexibility when collapsed
Rigid foot : maintains the geometry of the profile
Strong adhesive : allows a good holding without mechanical fixing

MATERIAL	FOOT	Grade :	Black EPDM
		Hardness :	95 Shores A
	TUBING	Grade :	black cellular rubber

MAXIMAL TEMPERATURES OF USE OF THE PROFILE (°C)		
Nonstop Static 80	Nonstop under constraints 70	Hottest (max duration 30 min) 110

ADHESIVE		
Peeling Behaviour at 90° 10 N/cm minimum	Pull out Behaviour 40 N/cm ²	Temperature of use from -30°C to +90°C

MINIMAL BENDING RADIUS (mm)			
X	Limit	Y	Limit
-	-	+20	tubing pinching
		-20	tubing collapse

GAP - Direction Y - (mm)				
		MINI	ADVISED	MAXI
Gap		3	4 5	6
Tubing collapse		100%	50% 30%	0%

For all inquiries feel free to contact : HUTCHINSON - Le Pommarin - BP 17 - 38430 MOIRANS
 Tel. +33 4 76 35 79 00 - Fax +33 4 76 35 79 09

