

# ER-F SERIES

Related Information

- General terms and conditions..... F-7
- Selection guide ..... P.1157~
- Glossary of terms..... P.1497
- General precautions ..... P.1501



[panasonic.net/id/pidsx/global](http://panasonic.net/id/pidsx/global)

## A compact shape for reducing workbench clutter

**Compact size of 150 × 166 × 62 mm (5.906 × 6.535 × 2.441 in)**  
**Low-volume fan type also available for various applications**

An ionizer with a 120 mm **4.724 in** fan diameter that has a class leading compact size for reducing workbench clutter and increasing efficiency.

Low-volume fan type with a suppressed fan speed of approx. half is available for charge removal in processes which involve handling of small parts or thin films.

\* Graphs represent typical values at 300 mm **11.811 in** from directly in front of air outlet, straight louver, with no filter installed.

**Standard fan type ER-F12**

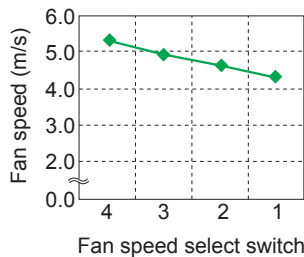

**Low-volume fan type ER-F12S**

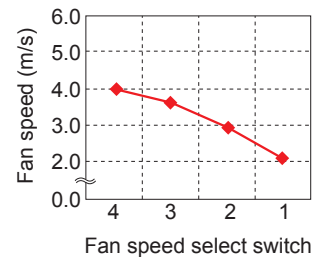

## Two exchangeable louvers to suit your needs

Just simply replace the louver to change configuration between long distance and wide area ionization.

The two louvers come with the ionizer main body.

**Straight louver**



Removes charges quickly at long distance

**Angle louver**



Removes charges completely in wide area

- FIBER SENSORS
- LASER SENSORS
- PHOTOELECTRIC SENSORS
- MICRO PHOTOELECTRIC SENSORS
- AREA SENSORS
- LIGHT CURTAINS / SAFETY COMPONENTS
- PRESSURE / FLOW SENSORS
- INDUCTIVE PROXIMITY SENSORS
- PARTICULAR USE SENSORS
- SENSOR OPTIONS
- SIMPLE WIRE-SAVING UNITS
- WIRE-SAVING SYSTEMS
- MEASUREMENT SENSORS
- STATIC ELECTRICITY PREVENTION DEVICES

- LASER MARKERS
- PLC
- HUMAN MACHINE INTERFACES
- ENERGY CONSUMPTION VISUALIZATION COMPONENTS
- FA COMPONENTS
- MACHINE VISION SYSTEMS
- UV CURING SYSTEMS

- Selection Guide
- Static Removers
- Cleaning Box
- Pulse Air-gun
- Electrostatic Sensor

- ER-X
- ER-TF
- ER-VS02
- ER-VW
- ER-Q
- ER-F

## Remove the louver for effortless maintenance

Because the discharge needle unit is attached to the louver, exchange or maintenance of the needles is made easy without touching the main unit. A safe design where once the louver is removed, the high-voltage circuit and the fan will halt.

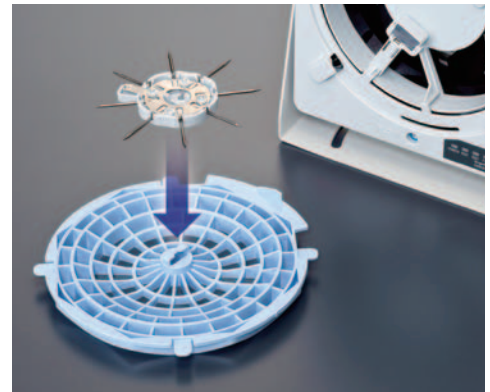

## ORDER GUIDE

Type	Appearance	Charge removal time ( $\pm 1,000\text{ V} \rightarrow \pm 100\text{ V}$ )	Ion balance	Model No.
Standard fan type		1 sec. approx. (Note 1)	$\pm 10\text{ V}$ or less (Note 2)	<b>ER-F12</b>
Low-volume fan type		1.5 sec. approx. (Note 1)		<b>ER-F12S</b>

Notes: 1) Typical value at 200 mm **7.874 in** from directly in front of air outlet, fan speed MAX, straight louver, with no filter installed.

2) Typical value at 300 mm **11.811 in** from directly in front of air outlet, fan speed MAX, straight louver, with no filter installed.

## OPTIONS

Type	Model No.	Description
AC adapter	<b>ER-FAPS-J2</b>	IN: 100 to 240 V AC 50 / 60 Hz OUT: 24 V DC, 1.5 A
	<b>ER-FAPS-EX</b> (Note)	Cable length between connector and AC adaptor: 1.8 m <b>5.905 ft</b> AC cable: 125 V rated (an accessory to <b>ER-FAPS-J2</b> only)
Discharge needle unit	<b>ER-F12ANT</b>	Unit with tungsten needles (1 pc.)
Air filter	<b>ER-F12FX5</b>	Replacement filter (5 pcs. per set)

Note: Please prepare an AC cable separately as it is needed.



Inlet configuration (IEC 60320-C13)

## APPLICATIONS

### Prevention of static charge in cell production

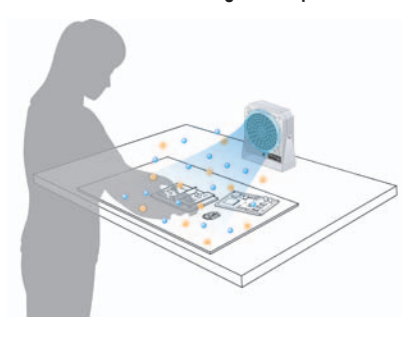
FIBER  
SENSORSLASER  
SENSORSPHOTO-  
ELECTRIC  
SENSORSMICRO  
PHOTO-  
ELECTRIC  
SENSORSAREA  
SENSORSLIGHT  
CURTAINS /  
SAFETY  
COMPONENTSPRESSURE /  
FLOW  
SENSORSINDUCTIVE  
PROXIMITY  
SENSORSPARTICULAR  
USE  
SENSORSSENSOR  
OPTIONSSIMPLE  
WIRE-SAVING  
UNITSWIRE-SAVING  
SYSTEMSMEASURE-  
MENT  
SENSORSSTATIC  
ELECTRICITY  
PREVENTION  
DEVICESLASER  
MARKERS

PLC

HUMAN  
MACHINE  
INTERFACESENERGY  
CONSUMPTION  
VISUALIZATION  
COMPONENTSFA  
COMPONENTSMACHINE  
VISION  
SYSTEMSUV  
CURING  
SYSTEMSSelection  
GuideStatic  
RemoversCleaning  
BoxPulse  
Air-gunElectrostatic  
Sensor**ER-X****ER-TF****ER-VS02****ER-VW****ER-Q****ER-F**

**SPECIFICATIONS**

Type	Standard fan type	Low-volume fan type
Item	<b>ER-F12</b>	<b>ER-F12S</b>
Charge removal time (±1,000 V → ±100 V)	1 sec. approx. (Note 2)	1.5 sec. approx. (Note 2)
Ion balance	±10 V or less (Note 3)	
Power supply voltage	24 V DC ±10 %	
Power consumption	700 mA or less	400 mA or less
Discharge method	High-frequency AC method	
Discharge output voltage	± 2 kV approx.	
Max. fan speed	5.3 m/s (Note 3)	4.0 m/s (Note 3)
Max. fan volume	3.68 m³/min	2.50 m³/min
Error output	NPN open-collector transistor • Max sink current: 50 mA • Applied voltage: 30 V DC or less (between output terminal and 0 V) • Residual voltage: 1 V or less (at input current of 50 mA)	
Output operation	OFF when discharge error or fan error detected Normally ON	
Short-circuit protection	Incorporated	
Discharge halt input	Discharge halt: Short-circuited to 0 V Discharge (operation start): Open	
Indicators	Discharge error (Red), Fan error (Red), Power (Green), Discharge (Green)	
Ozone generation amount	0.04 ppm or less (Note 2)	
Ambient temperature	0 to +50°C <b>+32 to +122°F</b> (No dew condensation) , Storage: -10 to +65°C <b>+14 to +149°F</b>	
Ambient humidity	35 to 65% RH (No dew condensation) , Storage: 35 to 65% RH	
Grounding method	C (capacitor) grounding	
Material	Enclosure: ABS, Louver: ABS, Discharge needle unit: PBT, Discharge needle: Tungsten, Bracket: SPHC	
Weight	4 Main unit: 790 g approx.	
Accessories	Straight louver: 1 pc. (Note 4), Angle louver: 1 pc., Caution label: 1 set, Rubber cushion: 1 pc.	

- Notes: 1) Where measurement conditions have not been specified precisely, the conditions used were an ambient temperature of +20 °C **+68 °F**.  
 2) Typical value at 200 mm **7.874 in** from directly in front of air outlet, fan speed MAX, straight louver, with no filter installed.  
 3) Typical value at 300 mm **11.811 in** from directly in front of air outlet, fan speed MAX, straight louver, with no filter installed.  
 4) The discharge needle unit is loaded on the straight louver before shipment.

**I/O CIRCUIT AND WIRING DIAGRAMS**

**I/O circuit diagram**

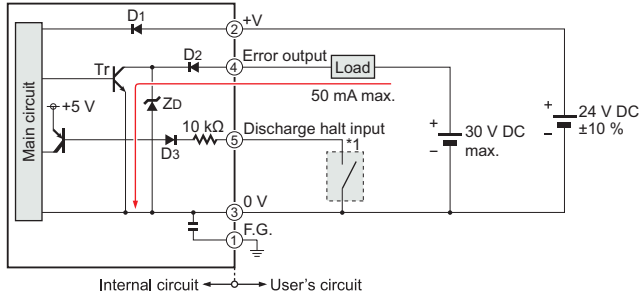

\* 1  
 Non-voltage contact or NPN open-collector transistor  
 Low (0 V): Discharge halt  
 High (Open): Discharge (Operation starts)

Symbols ... D1 : Reverse supply polarity protection diode  
 D2 : Output protection diode  
 D3 : Input protection diode  
 Zd : Surge absorption zener diode  
 Tr : NPN output transistor

**Connector terminal arrangement**

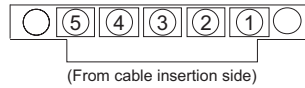

Terminal No.	Color code
①	F.G.
②	+V
③	0 V
④	Error output
⑤	Discharge halt input

**Recommended wiring cable**

Compatible wire: 25 AWG to 12 AWG (nominal cross-sectional area: 0.16 to 3.3 mm<sup>2</sup>)  
 Wire stripping length: 7 mm (see below)

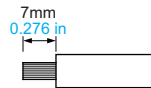

Note: Do not solder-plate the ends of wires being connected to connectors. Doing so may result in loosening of tightened screws, causing the wire to come loose.

## CHARGE REMOVAL CHARACTERISTICS (TYPICAL)

Measured using a 150 mm × 150 mm 5.906 in × 5.906 in CPM (charge plate monitor) (At center of CPM)

### ER-F12 ER-F12S

Solid lines in the graphs show **ER-F12**. Dotted lines show **ER-F12S**.

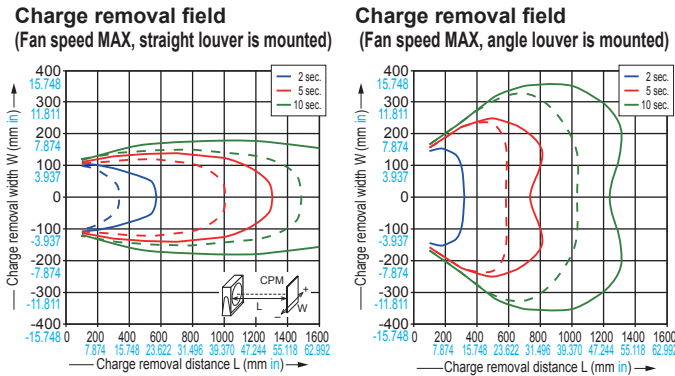

## PRECAUTIONS FOR PROPER USE

Refer to p.1501 for general precautions.



- Never use this product in a device for personnel protection.
- In case of using sensing devices for personnel protection, use products which meet laws and standards, such as OSHA, ANSI or IEC etc., for personnel protection applicable in each region or country.
- Do not use this product in places where there may be a danger of flammable or combustible items being present.
- If this product is used in an airtight room, ozone emitted from this product may be detrimental. Therefore, in order for this product to be used in an airtight room, be sure to keep the room ventilated.
- Since the tip of the discharge needle is sharp, take sufficient care in handling the discharge needle.
- Clean the discharge needle regularly, otherwise optimum charge removal performance may not be obtained and fire or operating problems may occur.
- Be sure to ground the frame ground (F.G.) terminal.

## DIMENSIONS (Unit: mm in)

The CAD data in the dimensions can be downloaded from our website.

### ER-F12 ER-F12S

Ionizer main unit

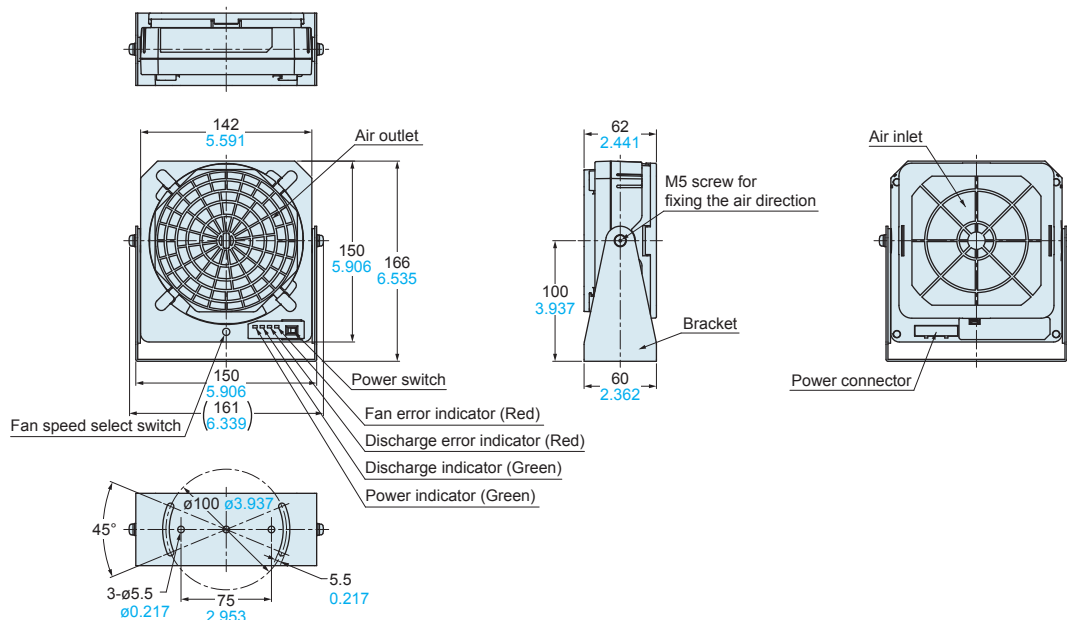

FIBER SENSORS

LASER SENSORS

PHOTO-ELECTRIC SENSORS

MICRO PHOTO-ELECTRIC SENSORS

AREA SENSORS

LIGHT CURTAINS / SAFETY COMPONENTS

PRESSURE / FLOW SENSORS

INDUCTIVE PROXIMITY SENSORS

PARTICULAR USE SENSORS

SENSOR OPTIONS

SMILE WIRE-SAVING UNITS

WIRE-SAVING SYSTEMS

MEASURE-MENT SENSORS

LASER MARKERS

STATIC ELECTRICITY PREVENTION DEVICES

PLC

HUMAN MACHINE INTERFACES

ENERGY CONSUMPTION VISUALIZATION COMPONENTS

FA COMPONENTS

MACHINE VISION SYSTEMS

UV CURING SYSTEMS

Selection Guide

Static Removers

Cleaning Box

Pulse Air-gun

Electrostatic Sensor

ER-X

ER-TF

ER-VS02

ER-VW

ER-Q

ER-F