



PRODUCT CATALOG



“We are here with all our strength to realize the dream of a “sustainable and smart **industry**” by presenting the future-oriented power of **warning lights** to the sector.”

Welcome Costumers

Our production story started in 2010 in Beyoğlu, Istanbul, after 12 years of market experience, in a small workshop, with the confidence we have in our country. Despite the difficult conditions of the period, we believed in Mucco's success. We proceeded patiently and developed on this road that we set out with limited means.

We continued to produce and add value for this country without losing our initial excitement. As the Mucco family, following the innovations and struggling with difficulties have been our top priority principles.

We continued to produce and add value for this country without losing our initial excitement. As the Mucco family, following the innovations and struggling with difficulties have been our top priority principles.

At the same time, we care about stability in adapting to the world's developments by preserving our traditional values. In this rapid globalization process, we continue to add value to our worldwide customers by getting in touch with them.













Kasım Cakmaktas

CEO

**Sinyalteknik Elektrik
Otomasyon İth.İhr.San. ve
Tic.Ltd.Sti**

As MUCCO Signalteknik, our quality management policy's main principle is to develop applicable, sustainable economic methods. We provide our customers with our technical support pre-sale and after-sales to present our products to domestic & foreign markets. We adopt a quality policy to meet customer satisfaction without sacrificing quality, fulfill our after-sale service responsibility, comply with legal regulations and obligations, continuously develop and improve, and provide an efficient and reliable working environment.

TABLE OF CONTENTS

	10		28		40		66
<p>Stack Lights</p> <p>Multilayered visual and audible indicators of a machine's status.</p>		<p>Multicolor RGB Warning Lights</p> <p>Multicolor RGB Series is high-quality and energy-efficient indicators that provide several different color options with a mixing of primary colors Red, Green, and Blue.</p>		<p>Universal Signal Beacons</p> <p>Multifunction beacons offer the advantage that a single beacon can cover several functions.</p>		<p>Universal LED Horns</p> <p>Multi-sound with Multi-light LED Horns offers a perfect combination for the highest signaling and alerting.</p>	
	80		94		102		112
<p>Universal Beacon Horns</p> <p>Combined Visual-Audible signaling horns for more control and safety.</p>		<p>Electronic Sirens</p> <p>Acoustic signals warn, protect, and guide us in modern industrial society.</p>		<p>Obstruction Lights</p> <p>Obstruction lights are vital in making high-rise buildings, towers and wind turbines visible to passing aircraft.</p>		<p>Heavy Duty Warning Lights</p> <p>Heavy Duty Multi-Tone Sounders well-suited for use in public areas or harsh industrial environments.</p>	
	124		128		136		142
<p>Safety Lights</p> <p>Visual warning for more safety: promotes workplace safety by preventing dangerous pedestrian and vehicle collisions. Easily mounted to a forklift and cranes.</p>		<p>Machine Tool Lights</p> <p>Machine interior lighting, the places which need local accent lighting such as carved machine, sparks machine, laser machinery, ceramic machinery and automated.....</p>		<p>Motor Sirens</p> <p>Motor sirens designed to give an effective warning over wide areas. The powerful low-frequency sound is ideal for covering long distances and is instantly recognizable.</p>		<p>Spare Parts</p> <p>Lens, housing parts, led modules, mounting brackets and etc.</p>	



DOMESTIC GOODS CERTIFICATES;
MADE IN TURKEY

Is a Certificate given by chambers and exchanges connected to TOBB by taking into consideration of industrial registry report and capacity report, which is issued only to domestic manufacturers and show that the related products are made in Turkey.



ISO 9001 QUALITY MANAGEMENT

INTERNATIONAL ORGANIZATION FOR STANDARDIZATION: ISO certification confirms that a management system, manufacturing process, service or documentation procedure has all the requirements for standardization and quality assurance.



CE CERTIFICATE OF CONFORMITY
 (EUROPEAN CONFORMITY):
 The manufacturer drew up CE mark - declaration demonstrates the fulfillment of the EU requirements and within the security requirements.



E-MARK:
 EUROPEAN VEHICLE APPROVAL:
 This approval symbol documents that the minimum technical requirements for use on vehicles.



EAC CERTIFICATE OF CONFORMITY:

The European conformity symbol EAC is provided by the Russia, Belarus, Kazakhstan customs union. The EAC symbol indicates that the product has undergone compliance procedures and fulfills its technical requirements.



RoHS CERTIFICATE OF CONFORMITY:

RoHS stands for Restriction of Hazardous Substances originated in the European Union and restricted the use of specific hazardous materials found in electrical and electronic products.



IP CERTIFICATE OF CONFORMITY:
 INGRESS PROTECTION
 As defined in International Standard IEC, Ingress Protection Rating classifies the degrees of protection of mechanical or electronic devices to water, dust, or external impacts.

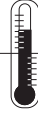

Working Temperature In Highest And Lowest Rating.



LED Led Type.

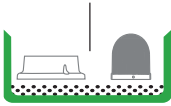

Raw Material



Minimum and Maximum Volume Range.



Impact Resistance



Warranty Period Against Manufacturing Defects



WEEE: Electrical Waste
 Dispose In Accordance With Local Regulations.

- IP 0X :** No protection
- IP 1X :** Protection against a solid object greater than 50 mm such as a hand.
- IP 2X :** Protection against a solid object greater than 12,5mm such as a finger.
- IP 3X :** Protection against a solid object greater than 2,5mm such as a screwdriver.
- IP 4X :** Protection against a solid object greater than 1 mm such as a wire.
- IP 5X :** Dust protected. Limited ingress of dust permitted. Will not interfere with operation of the equipment.
- IP 6X :** Dust tight. No ingress of dust.

- IP X0 :** No protection
- IP X1 :** Protection against vertically falling water drops. Limited ingress permitted.
- IP X2 :** Protection against vertically falling water drops with enclosure tilted up to 15 degrees from the vertical. Limited ingress permitted.
- IP X3 :** Protection against water sprays up to 60 degrees to the vertical. Limited ingress permitted.
- IP X4 :** Protection against water splashed from all directions. Limited ingress permitted.
- IP X5 :** Protection against jets of water. Limited ingress permitted.
- IP X6 :** Protection against heavy seas. Powerful jets shall not enter the enclosure in harmful quantities.
- IP X7 :** Protection against the effects of immersion in water between 15 cm and 1 m for 30 minutes.
- IP X8 :** Protection against the effects of immersion in water under pressure for long periods.

Rating Example:

IP 65

INGRESSPROTECTION

Table of working range

	Distance in m											
	1	2	3	5	10	20	30	50	100	200	300	500
120	114	110	106	100	94	90	86	80	74	70	66	60
118	112	108	104	98	92	88	84	78	72	68	64	58
116	110	106	102	96	90	86	82	76	70	66	62	56
114	108	104	100	94	88	84	80	74	68	64	60	54
112	106	102	98	92	86	82	78	72	66	62	58	52
110	104	100	96	90	84	80	76	70	64	60	56	50
108	102	98	94	88	82	78	74	68	62	58	54	48
106	100	96	92	86	80	76	72	66	60	56	52	46
104	98	94	90	84	78	74	70	64	58	54	50	44
102	96	92	88	82	76	72	68	62	56	52	48	42
100	94	90	86	80	74	70	66	60	54	50	46	40
98	92	88	84	78	72	68	64	58	52	48	44	38
96	90	86	82	76	70	66	62	56	50	46	42	
94	88	84	80	74	68	64	60	54	48	44	40	
92	86	82	78	72	66	62	58	52	46	42	38	
90	84	80	76	70	64	60	56	50	44	40		
85	79	75	71	65	59	55	51	45	39			
80	74	70	66	60	54	50	46	40				
75	69	65	61	55	49	45	41					
70	64	60	56	50	44	40	36					
65	59	55	51	45	39	35						

Examples of noise in everyday life

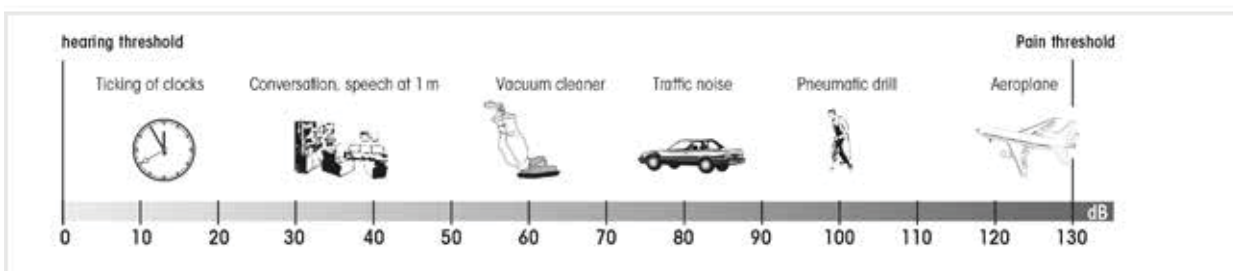

Why Mucco?

Mucco Signaltechnik has managed to become one of the leading companies in the audio-visual warning lights sector since 2010. Providing customer-oriented solutions and reaching solutions by using the highest quality raw materials provides a great opportunity for customers. They can both find quick solutions to their problems and take advantage of the opportunities Mucco provides them with reasonable prices.

Mucco Signature uses SMD LED and POWER LED to keep the light quality at the highest level while producing warning lamps. Polycarbonate raw material is used in the production of lenses in order to bring the light transmission and diffusion to the highest quality level. In addition, ABS raw material is used in the bodies of the products to provide great resistance to impacts and vibrations.

In this way, it is possible to find the most economical and best quality warning lights products at Mucco Signaltechnik. Thank you for choosing us. As we always say “Our aim is to warning”

Our Vision and Mission

The 4th industrial revolution we know as Industry 4.0 is coming! The first industrial revolution was at the center of production using water and steam power. The second industrial revolution then initiated mass production with the help of electric power, followed by the digital revolution.

In the future, businesses will build automation-based networks that combine their machines, storage systems and production facilities. In this process, as Mucco Signaltechnik, we will produce the most suitable and most usable warning lights for engineers who control the process remotely in smart machines, storage systems and production facilities in this production environment.

In this sense, we are aware that we play a big role in Industry 4.0 as a warning lamp manufacturer and we make our future plans accordingly.







MUCCO
WORKING LAMP
MADE IN GERMANY



Stack Lights



RGB Warning Lights



Signal Beacons



LED Warning Horns



Beacon Horns



Electronic Sirens



- Stack lights are used in a variety of machines and process environments; specific color-coding is assigned by the system designer.
- Commonly used color codes for machine state conditions include:
 - RED: Failure conditions such as an emergency stop or machine fault
 - YELLOW: Warnings such as over-temperature or over-pressure conditions
 - GREEN: Normal machine or process operation
 - BLUE: External help request, where an operator might be requesting raw materials, scheduling or maintenance personnel assistance
 - WHITE: User-defined conditions to a specific machine, often related to productivity monitoring

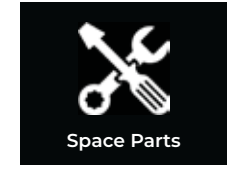

STACK LIGHTS

Stack Lights ideally suited for status indication in industrial manufacturing and process control environments where a local visual and audible signal is required.

- Lens: Polycarbonate
- Lens Diameter: 70mm
- LED Module: SMD
- LED life duration: 50.000 hrs
- Light Colors: Red, Green, Yellow, Blue, White
- Light Modes: Steady, Flashing, Strobing, Rotary
- Sound: 2 melodies
- Volume: 103-116dB
- Sound and Light can be controlled separately
- Housing: ABS
- Mounting Types: Surface & Wall
- Does not affected by water, dust, heat and UV rays
- Warranty: 2 Years

Voltage Options:

7013: 12-24V AC/DC

7024: 24V/DC

7022: 40-260V AC/DC

7012: 220V/AC

For more Details

Scan the QR Code for more information about the product



- Before making electrical connections to the products, please read the user manuals included in the box!
- Do not energize signal and contact cables other than the power cable (2x0.50mm).
- The product is out of warranty when the signal and contact cables are energized.
- The connection of the product should be made by at least electric technicians.

12V DC · 24V DC · 220V AC

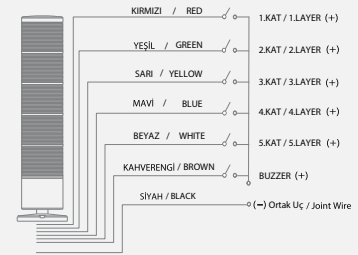

12-24V AC/DC

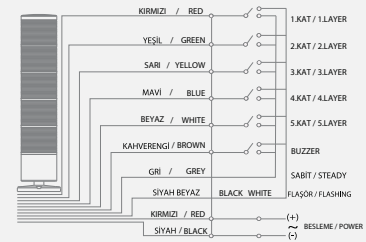

40-260V AC/DC

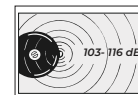
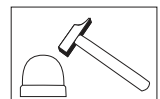
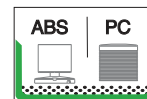
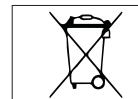
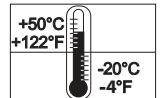
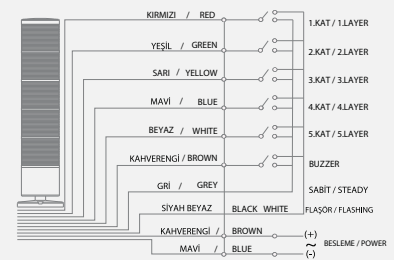

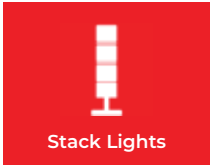

Stack Lights



RGB Warning Lights



Signal Beacons



LED Warning Horns

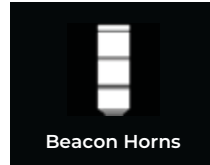

Beacon Horns



Electronic Sirens



STACK LIGHT

Stack Light with 1 Layer

Voltage Options:

- 7013: 12-24V AC/DC
- 7024: 24V/DC
- 7022: 40-260V AC/DC
- 7012: 220V/AC

- LED Module: SMD
- Light Colors: Red, Green, Yellow, Blue, White
- Light Modes: Steady, Flashing, Strobing, Rotary
- Sound: 2 melodies
- Volume: 103-116dB
- Mounting Types: Surface & Wall
- Lens Diameter: 70mm

SNT-7013-F1-1

»» Products Colors



SNT-7013-F1-2



SNT-7013-F1-3



SNT-7013-F1-4



SNT-7013-F1-5

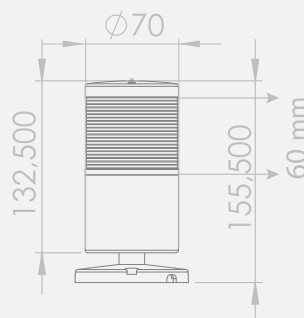
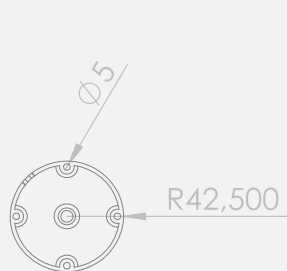



Obstruction Lights



Heavy Duty Lights



Safety Lights



Machine Tool Lights



Motor Sirens



Space Parts



STACK LIGHT

Stack Light with 2 Layer

Voltage Options:

- 7013: 12-24V AC/DC
- 7024: 24V/DC
- 7022: 40-260V AC/DC
- 7012: 220V/AC

- LED Module: SMD
- Standard Color Range: Red-Green
- Light Modes: Steady, Flashing, Strobging, Rotary
- Sound: 2 melodies
- Volume: 103-116dB
- Mounting Types: Surface & Wall
- Lens Diameter: 70mm

»» Similar Products



SNT-7013-F2-L



SNT-7013-F2-10U



SNT-7013-F2-D-20U



SNT-7013-F2-L-30U

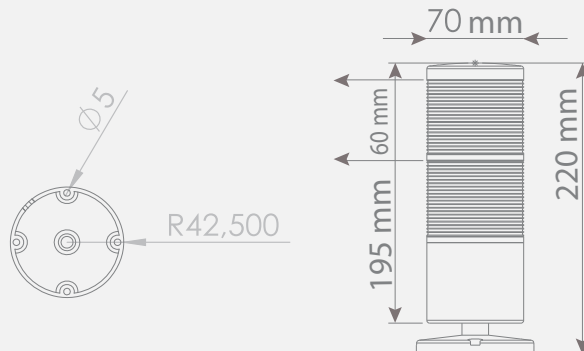

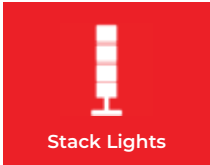

Stack Lights



RGB Warning Lights



Signal Beacons



LED Warning Horns

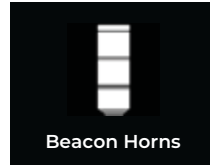

Beacon Horns



Electronic Sirens



STACK LIGHT

Stack Light with 3 Layer

Voltage Options:

7013: 12-24V AC/DC

7024: 24V/DC

7022: 40-260V AC/DC

7012: 220V/AC

- LED Module: SMD
- Standard Color Range: Red-Green-Yellow
- Light Modes: Steady, Flashing, Strobing, Rotary
- Sound: 2 melodies
- Volume: 103-116dB
- Mounting Types: Surface & Wall
- Lens Diameter: 70mm

Similar Products



SNT-7013-F3-L



SNT-7013-F3-10U



SNT-7013-F3-D-20U



SNT-7013-F3-L-30U

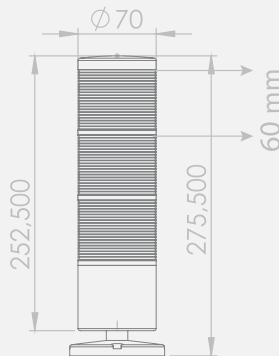
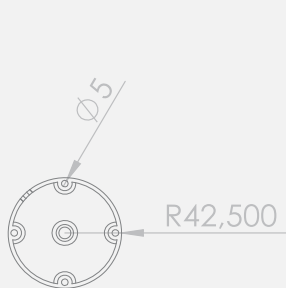



Obstruction Lights



Heavy Duty Lights



Safety Lights



Machine Tool Lights



Motor Sirens



Space Parts



STACK LIGHT

Stack Light with 4 Layer

Voltage Options:

7013: 12-24V AC/DC

7024: 24V/DC

7022: 40-260V AC/DC

7012: 220V/AC

- LED Module: SMD
- Standard Color Range: Red-Green-Yellow-Blue
- Light Modes: Steady, Flashing, Strobging, Rotary
- Sound: 2 melodies
- Volume: 103-116dB
- Mounting Types: Surface & Wall
- Lens Diameter: 70mm

»» Similar Products



SNT-7013-F4-L



SNT-7013-F4-10U



SNT-7013-F4-L-20U



SNT-7013-F4-D-30U

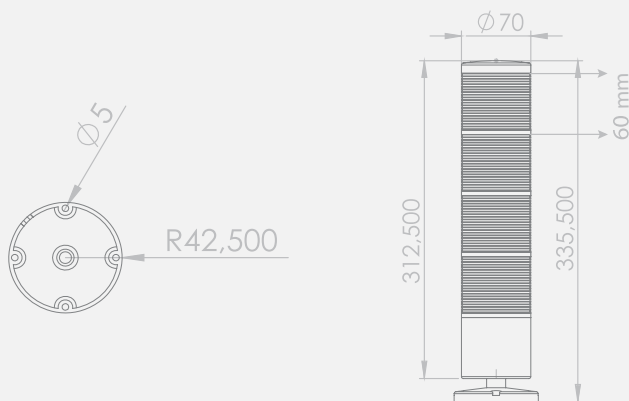

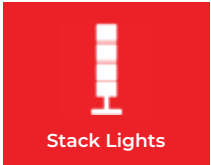

Stack Lights



RGB Warning Lights



Signal Beacons



LED Warning Horns



Beacon Horns



Electronic Sirens



STACK LIGHT

Stack Light with 5 Layer

Voltage Options:

- 7013: 12-24V AC/DC
- 7024: 24V/DC
- 7022: 40-260V AC/DC
- 7012: 220V/AC

- LED Module: SMD
- Standard Color Range: Red-Green
- Light Modes: Steady, Flashing, Strobging, Rotary
- Sound: 2 melodies
- Volume: 103-116dB
- Mounting Types: Surface & Wall
- Lens Diameter: 70mm

Similar Products



SNT-7013-F5-L



SNT-7013-F5-10U



SNT-7013-F5-D-20U



SNT-7013-F5-L-30U

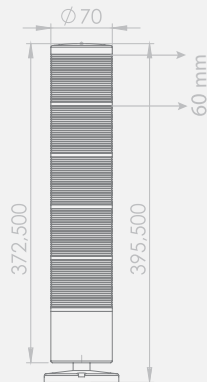
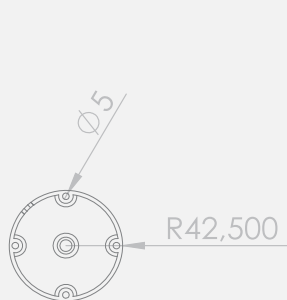



Obstruction Lights



Heavy Duty Lights



Safety Lights



Machine Tool Lights



Motor Sirens

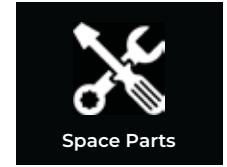

Space Parts



Modular Stack Lights

COMING SOON!

● Utility Model Patent No: 2020/02237

PRODUCT CODE

SNT

7022

F

Modes

SNT

Series

Lens Diameter Voltage

ø70mm

70

13

12-24V AC/DC

24

24V/DC

22

40-260V AC/DC

12

220V/AC



- Light codes must be indicated on one layer Stack Lights.
- For non-standard color options on 2,3,4 and 5 layer Stack lights, contact the company.
- For non-standard voltage options contact the company.
- When an **"L"** is added to the end of the code in your orders, the product is produced with a wall mount. The price remains the same in orders of products with Wall Bracket.
- When an **"D"** is added to the end of the code in your orders, the product is produced with a foldable base.
- 7\$ is added to the price in orders of products with Foldable Base.
- When an **"10U-20U-30U"** is added to the end of the code in your orders, the product is produced with extension tubes. You can choose extension tube from page spare parts.
- 7013-7022 series products supplied stably from the motherboard.
- Do not supply the signal and contact wires except power cable (2x0.50).
- The product is out of warranty if you supply signal and layer wires.
- Do dry contact with Gray signal wire to operate the Steady, Strobe, Rotary light and Continuous Buzzer.
- Do dry contact with Black-White signal wire to operate the Flashing light and Intermittent Buzzer.

CODE GENERATOR

F B 1 - 3 - D - 10U

Light Modes

S

Steady

F

Flashing

C

Strobe

D

Rotary

Buzzer Options

B

With Buzzer

◇

Without Buzzer

Layer Options

1

2

3

4

5

Light Color Options

1

Red

2

Green

3

Yellow

4

Blue

5

White

◇

2,3,4 and 5 Layers

Mounting Options

◇

Surface Mount.

D

Foldable Base.

L

Wall Bracket.



Extension Tube Options

◇

Without tube

10U

10cm Tube

20U

20cm Tube

30U

30cm Tube

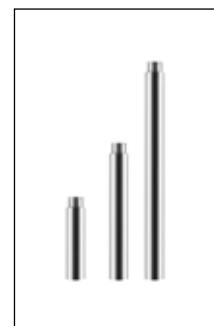

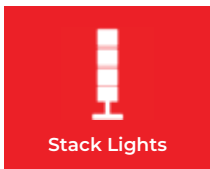

Stack Lights



RGB Warning Lights



Signal Beacons



LED Warning Horns

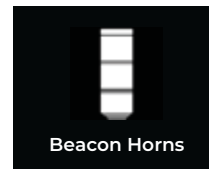

Beacon Horns



Electronic Sirens



Stack Light with One Layer

PART NO	LENS DIA.	TYPE	POWER SUPPLY
SNT-7013-S1-...	ø70	Continuous	12-24V AC/DC
SNT-7024-S1-...	ø70	Continuous	24V/DC
SNT-7022-S1-...	ø70	Continuous	40-260V AC/DC
SNT-7012-S1-...	ø70	Continuous	220V AC/DC
SNT-7013-F1-...	ø70	Flashing	12-24V AC/DC
SNT-7024-F1-...	ø70	Flashing	24V/DC
SNT-7022-F1-...	ø70	Flashing	40-260V AC/DC
SNT-7012-F1-...	ø70	Flashing	220V AC/DC
SNT-7013-C1-...	ø70	Strobe	12-24V AC/DC
SNT-7024-C1-...	ø70	Strobe	24V/DC
SNT-7022-C1-...	ø70	Strobe	40-260V AC/DC
SNT-7012-C1-...	ø70	Strobe	220V AC/DC
SNT-7013-D1-...	ø70	Rotary	12-24V AC/DC
SNT-7024-D1-...	ø70	Rotary	24V/DC
SNT-7022-D1-...	ø70	Rotary	40-260V AC/DC
SNT-7012-D1-...	ø70	Rotary	220V AC/DC
SNT-7013-SB1-...	ø70	Continuous-Buzzer	12-24V AC/DC
SNT-7024-SB1-...	ø70	Continuous-Buzzer	24V/DC
SNT-7022-SB1-...	ø70	Continuous-Buzzer	40-260V AC/DC
SNT-7012-SB1-...	ø70	Continuous-Buzzer	220V AC/DC
SNT-7013-FB1-...	ø70	Flashing-Buzzer	12-24V AC/DC
SNT-7024-FB1-...	ø70	Flashing-Buzzer	24V/DC
SNT-7022-FB1-...	ø70	Flashing-Buzzer	40-260V AC/DC
SNT-7012-FB1-...	ø70	Flashing-Buzzer	220V AC/DC
SNT-7013-CB1-...	ø70	Strobe-Buzzer	12-24V AC/DC
SNT-7024-CB1-...	ø70	Strobe-Buzzer	24V/DC
SNT-7022-CB1-...	ø70	Strobe-Buzzer	40-260V AC/DC
SNT-7012-CB1-...	ø70	Strobe-Buzzer	220V AC/DC
SNT-7013-DB1-...	ø70	Rotary-Buzzer	12-24V AC/DC
SNT-7024-DB1-...	ø70	Rotary-Buzzer	24V/DC
SNT-7022-DB1-...	ø70	Rotary-Buzzer	40-260V AC/DC
SNT-7012-DB1-...	ø70	Rotary-Buzzer	220V AC/DC

1 2 3 4 5

!!!! Light codes must be indicated on one layer Stack Lights.



Obstruction Lights



Heavy Duty Lights



Safety Lights



Machine Tool Lights



Motor Sirens



Space Parts



Stack Light with Two Layers

PART NO	LENS DIA.	TYPE	POWER SUPPLY
SNT-7013-S2	ø70	Continuous	12-24V AC/DC
SNT-7024-S2	ø70	Continuous	24V/DC
SNT-7022-S2	ø70	Continuous	40-260V AC/DC
SNT-7012-S2	ø70	Continuous	220V AC/DC
SNT-7013-F2	ø70	Flashing	12-24V AC/DC
SNT-7024-F2	ø70	Flashing	24V/DC
SNT-7022-F2	ø70	Flashing	40-260V AC/DC
SNT-7012-F2	ø70	Flashing	220V AC/DC
SNT-7013-C2	ø70	Strobe	12-24V AC/DC
SNT-7024-C2	ø70	Strobe	24V/DC
SNT-7022-C2	ø70	Strobe	40-260V AC/DC
SNT-7012-C2	ø70	Strobe	220V AC/DC
SNT-7013-D2	ø70	Rotary	12-24V AC/DC
SNT-7024-D2	ø70	Rotary	24V/DC
SNT-7022-D2	ø70	Rotary	40-260V AC/DC
SNT-7012-D2	ø70	Rotary	220V AC/DC
SNT-7013-SB2	ø70	Continuous-Buzzer	12-24V AC/DC
SNT-7024-SB2	ø70	Continuous-Buzzer	24V/DC
SNT-7022-SB2	ø70	Continuous-Buzzer	40-260V AC/DC
SNT-7012-SB2	ø70	Continuous-Buzzer	220V AC/DC
SNT-7013-FB2	ø70	Flashing-Buzzer	12-24V AC/DC
SNT-7024-FB2	ø70	Flashing-Buzzer	24V/DC
SNT-7022-FB2	ø70	Flashing-Buzzer	40-260V AC/DC
SNT-7012-FB2	ø70	Flashing-Buzzer	220V AC/DC
SNT-7013-CB2	ø70	Strobe-Buzzer	12-24V AC/DC
SNT-7024-CB2	ø70	Strobe-Buzzer	24V/DC
SNT-7022-CB2	ø70	Strobe-Buzzer	40-260V AC/DC
SNT-7012-CB2	ø70	Strobe-Buzzer	220V AC/DC
SNT-7013-DB2	ø70	Rotary-Buzzer	12-24V AC/DC
SNT-7024-DB2	ø70	Rotary-Buzzer	24V/DC
SNT-7022-DB2	ø70	Rotary-Buzzer	40-260V AC/DC
SNT-7012-DB2	ø70	Rotary-Buzzer	220V AC/DC

!!!! Standard Color Range; Red-Green For non stand color range contact company.

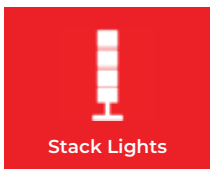

Stack Lights



RGB Warning Lights

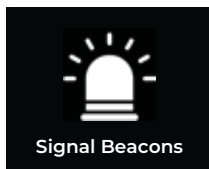

Signal Beacons



LED Warning Horns

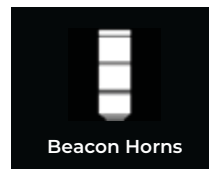

Beacon Horns



Electronic Sirens



Stack Light with Three Layers

PART NO	LENS DIA.	TYPE	POWER SUPPLY
SNT-7013-S3	ø70	Continuous	12-24V AC/DC
SNT-7024-S3	ø70	Continuous	24V/DC
SNT-7022-S3	ø70	Continuous	40-260V AC/DC
SNT-7012-S3	ø70	Continuous	220V AC/DC
SNT-7013-F3	ø70	Flashing	12-24V AC/DC
SNT-7024-F3	ø70	Flashing	24V/DC
SNT-7022-F3	ø70	Flashing	40-260V AC/DC
SNT-7012-F3	ø70	Flashing	220V AC/DC
SNT-7013-C3	ø70	Strobe	12-24V AC/DC
SNT-7024-C3	ø70	Strobe	24V/DC
SNT-7022-C3	ø70	Strobe	40-260V AC/DC
SNT-7012-C3	ø70	Strobe	220V AC/DC
SNT-7013-D3	ø70	Rotary	12-24V AC/DC
SNT-7024-D3	ø70	Rotary	24V/DC
SNT-7022-D3	ø70	Rotary	40-260V AC/DC
SNT-7012-D3	ø70	Rotary	220V AC/DC
SNT-7013-SB3	ø70	Continuous-Buzzer	12-24V AC/DC
SNT-7024-SB3	ø70	Continuous-Buzzer	24V/DC
SNT-7022-SB3	ø70	Continuous-Buzzer	40-260V AC/DC
SNT-7012-SB3	ø70	Continuous-Buzzer	220V AC/DC
SNT-7013-FB3	ø70	Flashing-Buzzer	12-24V AC/DC
SNT-7024-FB3	ø70	Flashing-Buzzer	24V/DC
SNT-7022-FB3	ø70	Flashing-Buzzer	40-260V AC/DC
SNT-7012-FB3	ø70	Flashing-Buzzer	220V AC/DC
SNT-7013-CB3	ø70	Strobe-Buzzer	12-24V AC/DC
SNT-7024-CB3	ø70	Strobe-Buzzer	24V/DC
SNT-7022-CB3	ø70	Strobe-Buzzer	40-260V AC/DC
SNT-7012-CB3	ø70	Strobe-Buzzer	220V AC/DC
SNT-7013-DB3	ø70	Rotary-Buzzer	12-24V AC/DC
SNT-7024-DB3	ø70	Rotary-Buzzer	24V/DC
SNT-7022-DB3	ø70	Rotary-Buzzer	40-260V AC/DC
SNT-7012-DB3	ø70	Rotary-Buzzer	220V AC/DC

!!!! Standard Color Range; Red-Green-Yellow For non stand color range contact company.



Stack Light with Four Layers

PART NO	LENS DIA.	TYPE	POWER SUPPLY
SNT-7013-S4	ø70	Continuous	12-24V AC/DC
SNT-7024-S4	ø70	Continuous	24V/DC
SNT-7022-S4	ø70	Continuous	40-260V AC/DC
SNT-7013-F4	ø70	Flashing	12-24V AC/DC
SNT-7024-F4	ø70	Flashing	24V/DC
SNT-7022-F4	ø70	Flashing	40-260V AC/DC
SNT-7013-C4	ø70	Strobe	12-24V AC/DC
SNT-7024-C4	ø70	Strobe	24V/DC
SNT-7022-C4	ø70	Strobe	40-260V AC/DC
SNT-7013-D4	ø70	Rotary	12-24V AC/DC
SNT-7024-D4	ø70	Rotary	24V/DC
SNT-7022-D4	ø70	Rotary	40-260V AC/DC
SNT-7013-SB4	ø70	Continuous-Buzzer	12-24V AC/DC
SNT-7024-SB4	ø70	Continuous-Buzzer	24V/DC
SNT-7022-SB4	ø70	Continuous-Buzzer	40-260V AC/DC
SNT-7013-FB4	ø70	Flashing-Buzzer	12-24V AC/DC
SNT-7024-FB4	ø70	Flashing-Buzzer	24V/DC
SNT-7022-FB4	ø70	Flashing-Buzzer	40-260V AC/DC
SNT-7013-CB4	ø70	Strobe-Buzzer	12-24V AC/DC
SNT-7024-CB4	ø70	Strobe-Buzzer	24V/DC
SNT-7022-CB4	ø70	Strobe-Buzzer	40-260V AC/DC
SNT-7013-DB4	ø70	Rotary-Buzzer	12-24V AC/DC
SNT-7024-DB4	ø70	Rotary-Buzzer	24V/DC
SNT-7022-DB4	ø70	Rotary-Buzzer	40-260V AC/DC

!!!! Standard Color Range; Red-Green-Yellow-Blue

For non stand color range contact company.

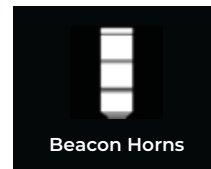

Stack Light with Five Layers

PART NO	LENS DIA.	TYPE	POWER SUPPLY
SNT-7013-S5	ø70	Continuous	12-24V AC/DC
SNT-7024-S5	ø70	Continuous	24V/DC
SNT-7022-S5	ø70	Continuous	40-260V AC/DC
SNT-7013-F5	ø70	Flashing	12-24V AC/DC
SNT-7024-F5	ø70	Flashing	24V/DC
SNT-7022-F5	ø70	Flashing	40-260V AC/DC
SNT-7013-C5	ø70	Strobe	12-24V AC/DC
SNT-7024-C5	ø70	Strobe	24V/DC
SNT-7022-C5	ø70	Strobe	40-260V AC/DC
SNT-7013-D5	ø70	Rotary	12-24V AC/DC
SNT-7024-D5	ø70	Rotary	24V/DC
SNT-7022-D5	ø70	Rotary	40-260V AC/DC
SNT-7013-SB5	ø70	Continuous-Buzzer	12-24V AC/DC
SNT-7024-SB5	ø70	Continuous-Buzzer	24V/DC
SNT-7022-SB5	ø70	Continuous-Buzzer	40-260V AC/DC
SNT-7013-FB5	ø70	Flashing-Buzzer	12-24V AC/DC
SNT-7024-FB5	ø70	Flashing-Buzzer	24V/DC
SNT-7022-FB5	ø70	Flashing-Buzzer	40-260V AC/DC
SNT-7013-CB5	ø70	Strobe-Buzzer	12-24V AC/DC
SNT-7024-CB5	ø70	Strobe-Buzzer	24V/DC
SNT-7022-CB5	ø70	Strobe-Buzzer	40-260V AC/DC
SNT-7013-DB5	ø70	Rotary-Buzzer	12-24V AC/DC
SNT-7024-DB5	ø70	Rotary-Buzzer	24V/DC
SNT-7022-DB5	ø70	Rotary-Buzzer	40-260V AC/DC

!!!! Standard Color Range; Red-Green-Yellow-Blue-White

For non stand color range contact company.



Stack Light - Led Module

PART NO	TYPE	COLOR
SNT-LK	Continuous Led Module	Red
SNT-LY	Continuous Led Module	Green
SNT-LS	Continuous Led Module	Yellow
SNT-LM	Continuous Led Module	Blue
SNT-LB	Continuous Led Module	White
SNT-LKP	Strobe-Rotary Led Module	Red
SNT-LYP	Strobe-Rotary Led Module	Green
SNT-LSP	Strobe-Rotary Led Module	Yellow
SNT-LMP	Strobe-Rotary Led Module	Blue
SNT-LBP	Strobe-Rotary Led Module	White



Stack Light - Lens

PART NO	TYPE	COLOR
SNT-70LNK	Ø70 PC-Lens	Red
SNT-70LNY	Ø70 PC-Lens	Green
SNT-70LNS	Ø70 PC-Lens	Yellow
SNT-70LNM	Ø70 PC-Lens	Blue
SNT-70LNB	Ø70 PC-Lens	Transparent
SNT-70KPK	Ø70 PC-Lens Cover	Red
SNT-70KPY	Ø70 PC-Lens Cover	Green
SNT-70KPS	Ø70 PC-Lens Cover	Yellow
SNT-70KPM	Ø70 PC-Lens Cover	Blue
SNT-70KPB	Ø70 PC-Lens Cover	Transparent



Stack Light - Mounting Spare Parts

PART NO	TYPE	COLOR
SNT-70TB	ABS Surface Bracket	Black
SNT-70D	ABS Foldable Base	Black
SNT-70L	ABS Wall Bracket	Black
SNT-10U	10cm Metal Extension Tube	Gray
SNT-20U	20cm Metal Extension Tube	Gray
SNT-30U	30cm Metal Extension Tube	Gray
SNT-70TLT	Metal Wall Bracket	Black





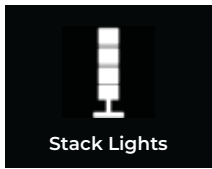

Stack Lights



RGB Warning Lights



Signal Beacons



LED Warning Horns



Beacon Horns



Electronic Sirens



- Color order priority: Red- Green- Blue- Yellow
- RGB products are current protected.
- They can be connected directly o PLC.
In Series 220V
- Products supplied stably from the motherboard.
- Do not supply the signal and contact wires except power cable (2x0.50).
- The product is out of warranty if you supply signal and layer wires.



MULTICOLOR RGB WARNING LIGHTS

Multicolor RGB Series is high-quality and energy-efficient indicators that provide several different color options with a mixing of primary colors Red, Green, and Blue.

- Lens: Polycarbonate
- Lens Diameters: 70mm, 90mm and 100mm
- LED Module: SMD
- LED life duration: 50.000 hrs
- Light Colors: Red-Green-Yellow-Blue
 - 4 Different colors with RGB LED technology
- Light Modes: Steady, Flashing, Strobging
- Sound: 16 melodies
- Volume: 70-130dB
- Sound and Light can be controlled separately
- Housing: ABS
- Mounting Types: Surface & Wall
- Does not affected by water, dust, heat and UV rays
- Warranty: 2 Years

Voltage Options:

SNT-74: 12-24V AC/DC
SNT-72: 40-260V AC/DC



- Before making electrical connections to the products, please read the user manuals included in the box!
- Do not energize signal and contact cables other than the power cable (2x0.50mm).
- The product is out of warranty when the signal and contact cables are energized.
- The connection of the product should be made by at least electric technicians.

12V-24V/DC

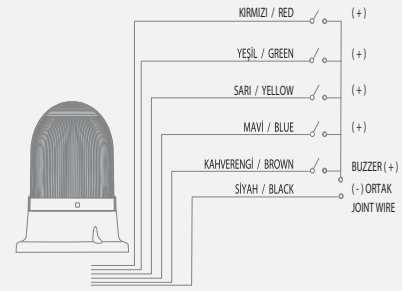

40-260V AC/DC

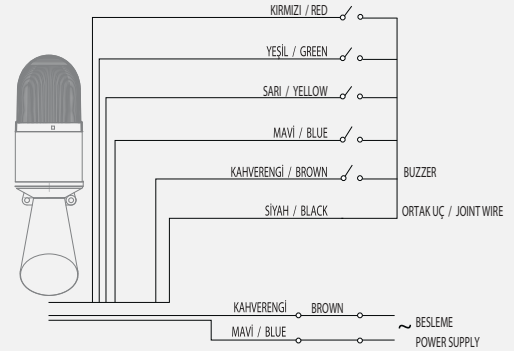

For more Details

Scan the QR Code for more information about the product

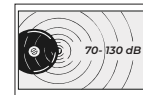
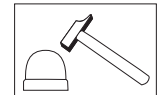
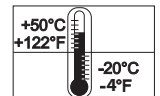



Stack Lights



RGB Warning Lights



Signal Beacons



LED Warning Horns



Beacon Horns



Electronic Sirens



70 RGB Signal Beacon

SNT-74-RGB-...

- LED Module: RGB SMD
- Light Modes: Steady, Flashing, Strobing
- Sound: 16 melodies
- Volume: 77-98dB
- Mounting Types: Surface & Wall
- Lens Diameter: 70mm
- Voltage: 12-24V AC/DC

Part no.	Buzzer
SNT-74-RGB	-
SNT-74-B-RGB	77-98dB

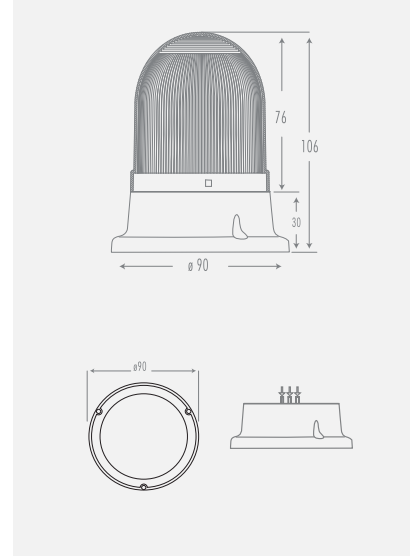

RGB Led Horn

SNT-B74-RGB

- LED Module: RGB SMD
- Light Modes: Steady, Flashing, Strobing
- Sound: 16 melodies
- Volume: 106-130dB
- Mounting Types: Wall
- Lens Diameter: 70mm
- Voltage: 12-24V AC/DC , 40-260V AC/DC

Part No.	Buzzer
SNT-B74-RGB	106-130dB
SNT-B72-RGB	106-130dB

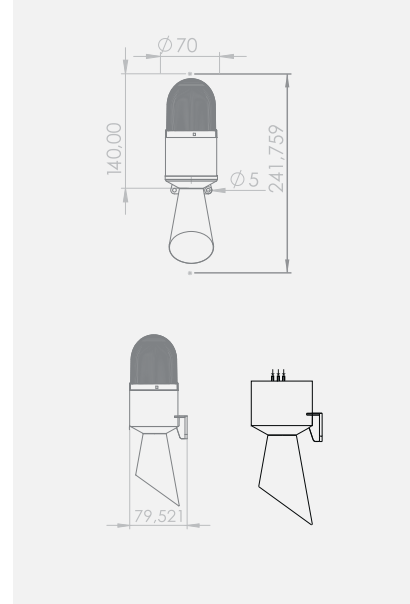

RGB Beacon Horn

SNT-K74-RGB

- LED Module: RGB SMD
- Light Modes: Steady, Flashing, Strobing
- Sound: 16 melodies
- Volume: 93-120dB
- Mounting Types: Wall
- Lens Diameter: 70mm
- Voltage: 12-24V AC/DC , 40-260V AC/DC

Part No.	Buzzer
SNT-K74-RGB	93-120dB
SNT-K72-RGB	93-120dB

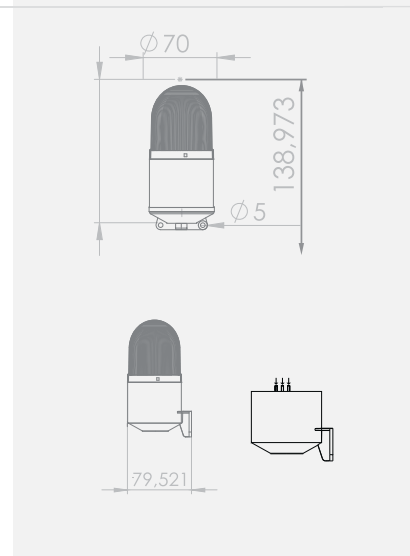

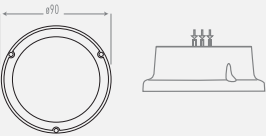
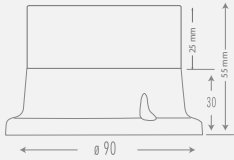

Mini RGB Signal Beacon

SNT-M74-RGB-...

- LED Module: RGB SMD
- Light Modes: Steady, Flashing, Strobging
- Sound: 16 melodies
- Volume: 77-98dB
- Mounting Types: Surface & Wall
- Lens Diameter: 70mm
- Voltage: 12-24V AC/DC



Part No.	Buzzer
SNT-M74-RGB	-
SNT-M74-B-RGB	77-98dB

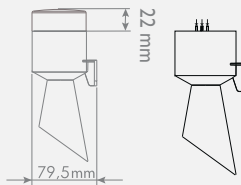
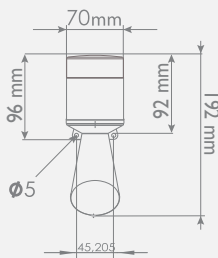

Mini RGB Led Horn

SNT-MB74-RGB

- LED Module: RGB SMD
- Light Modes: Steady, Flashing, Strobging
- Sound: 16 melodies
- Volume: 106-130dB
- Mounting Types: Wall
- Lens Diameter: 70mm
- Voltage: 12-24V AC/DC , 40-260V AC/DC



Part No.	Buzzer
SNT-MB74-RGB	106-130dB
SNT-MB72-RGB	106-130dB

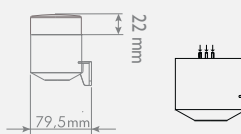
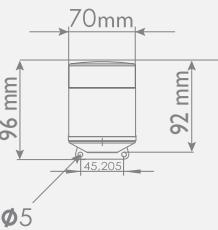

Mini RGB Beacon Horn

SNT-MK74-RGB

- LED Module: RGB SMD
- Light Modes: Steady, Flashing, Strobging
- Sound: 16 melodies
- Volume: 93-120dB
- Mounting Types: Wall
- Lens Diameter: 70mm
- Voltage: 12-24V AC/DC , 40-260V AC/DC



Part no.	Buzzer
SNT-MK74-RGB	93-120dB
SNT-MK72-RGB	93-120dB



Stack Lights



RGB Warning Lights



Signal Beacons



LED Warning Horns



Beacon Horns



Electronic Sirens



90 RGB Signal Beacon

SNT-915-RGB-...

- LED Module: RGB SMD
- Light Modes: Steady, Flashing, Strobing
- Sound: 16 melodies
- Volume: 93-120dB
- Mounting Types: Surface & Wall
- Lens Diameter: 90mm
- Voltage: 12-24V AC/DC , 40-260V AC/DC

Part no.	Buzzer
SNT-915-RGB	-
SNT-915-B-RGB	93-120dB
SNT-925-RGB	-
SNT-925-B-RGB	93-120dB

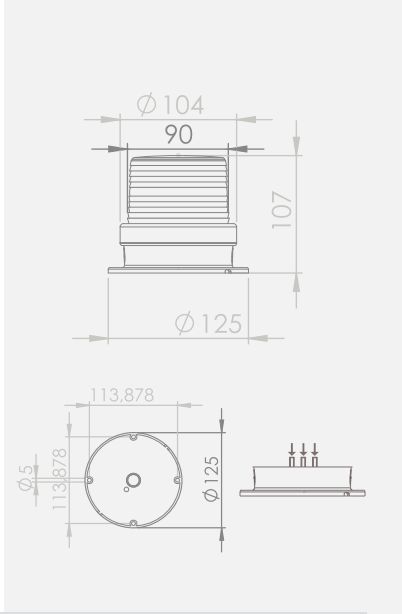

100 RGB Signal Beacon

SNT-115-RGB-...

- LED Module: RGB SMD
- Light Modes: Steady, Flashing, Strobing
- Sound: 16 melodies
- Volume: 93-120dB
- Mounting Types: Surface & Wall
- Lens Diameter: 100mm
- Voltage: 12-24V AC/DC , 40-260V AC/DC

Part no.	Buzzer
SNT-115-RGB	-
SNT-115-B-RGB	93-120dB
SNT-125-RGB	-
SNT-125-B-RGB	93-120dB

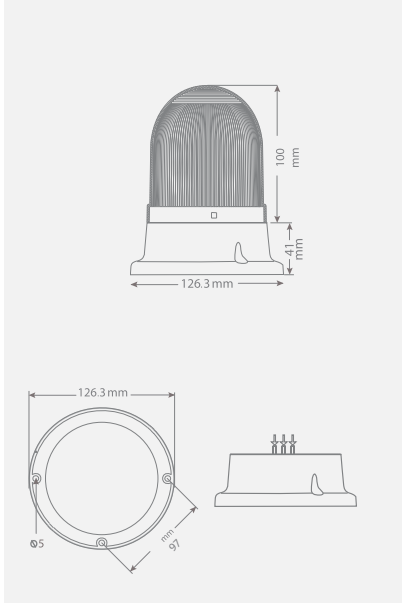

RGB Stack Light

SNT-T74-RGB-...

- LED Module: RGB SMD
- Light Modes: Steady, Flashing, Strobing
- Sound: 16 melodies
- Volume: 103-115dB
- Mounting Types: Surface & Wall
- Lens Diameter: 70mm
- Voltage: 12-24V AC/DC , 40-260V AC/DC

Part no.	Buzzer
SNT-T74-RGB	-
SNT-T74-B-RGB	103-115dB
SNT-T72-RGB	-
SNT-T72-B-RGB	103-115dB

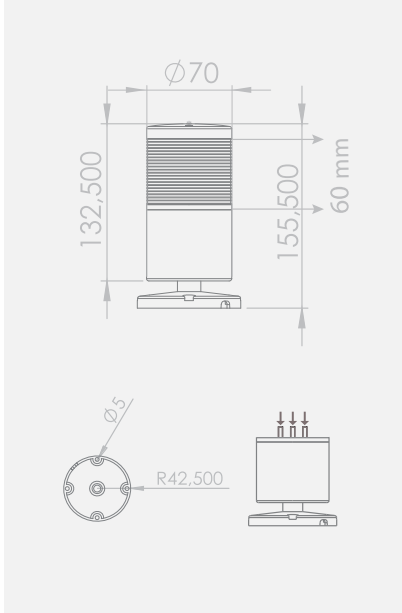

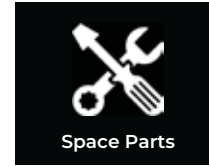

Nut-Connected RGB Signal Beacon

SNT-S74-RGB-...

- LED Module: RGB SMD
- Light Modes: Steady, Flashing, Strobging
- Sound: 16 melodies
- Volume: 83-105dB
- Mounting Types: Nut-Connection
- Lens Diameter: 70mm
- Voltage: 12-24V AC/DC

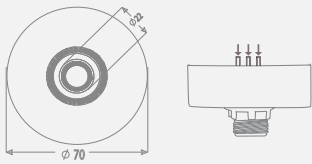
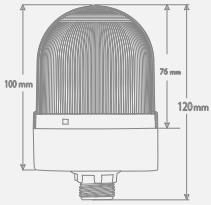

Part No.	Buzzer
SNT-S74-RGB	-
SNT-S74-B-RGB	83-105dB



Mini Ø22 RGB Signal Beacon

SNT-MS74-RGB-...

- LED Module: RGB SMD
- Light Modes: Steady, Flashing, Strobging
- Sound: 16 melodies
- Volume: 83-105dB
- Mounting Types: Nut-Connection
- Lens Diameter: 70mm
- Voltage: 12-24V AC/DC

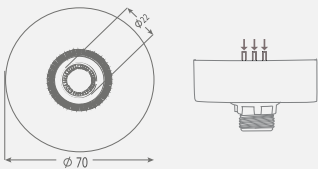
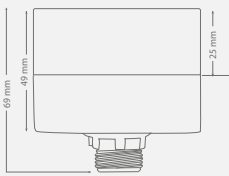

Part No.	Buzzer
SNT-MS74-RGB	-
SNT-MS74-B-RGB	83-105dB



Similar Products



SNT-T74-RGB-D



SNT-T74-RGB-10U



SNT-T74-RGB-L-20U



SNT-S74-RGB-10T



SNT-S74-RGB-20T



SNT-S74-RGB-30T

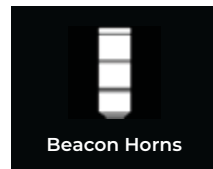

70 RGB Signal Beacon

PART NO	LENS DIA.	TYPE	POWER SUPPLY
SNT-74-RGB	ø70	3Modes	12-24V AC/DC
SNT-74-B-RGB	ø70	3Modes, Buzzer	12-24V AC/DC



Mini RGB Signal Beacon

PART NO	LENS DIA.	TYPE	POWER SUPPLY
SNT-M74-RGB	ø70	3Modes	12-24V AC/DC
SNT-M74-B-RGB	ø70	3Modes, Buzzer	12-24V AC/DC



Nut-Connected RGB Signal Beacon

PART NO	LENS DIA.	TYPE	POWER SUPPLY
SNT-S74-RGB	M22- Nut, ø70	3Modes	12-24V AC/DC
SNT-S74-B-RGB	M22- Nut, ø70	3Modes, Buzzer	12-24V AC/DC
SNT-S74-RGB-10T	M22- Nut, ø70	3Modes, 10cm Tube	12-24V AC/DC
SNT-S74-B-RGB-10T	M22- Nut, ø70	3Modes, Buzzer, 10cm Tube	12-24V AC/DC
SNT-S74-RGB-20T	M22- Nut, ø70	3Modes, 20cm Tube	12-24V AC/DC
SNT-S74-B-RGB-20T	M22- Nut, ø70	3Modes, Buzzer, 20cm Tube	12-24V AC/DC
SNT-S74-RGB-30T	M22- Nut, ø70	3Modes, 30cm Tube	12-24V AC/DC
SNT-S74-B-RGB-30T	M22- Nut, ø70	3Modes, Buzzer, 30cm Tube	12-24V AC/DC



Mini Nut-Connected RGB Signal Beacon

PART NO	LENS DIA.	TYPE	POWER SUPPLY
SNT-MS74-RGB	M22- Nut, ø70	3Modes	12-24V AC/DC
SNT-MS74-B-RGB	M22- Nut, ø70	3Modes, Buzzer	12-24V AC/DC
SNT-MS74-RGB-10T	M22- Nut, ø70	3Modes, 10cm Tube	12-24V AC/DC
SNT-MS74-B-RGB-10T	M22- Nut, ø70	3Modes, Buzzer, 10cm Tube	12-24V AC/DC
SNT-MS74-RGB-20T	M22- Nut, ø70	3Modes, 20cm Tube	12-24V AC/DC
SNT-MS74-B-RGB-20T	M22- Nut, ø70	3Modes, Buzzer, 20cm Tube	12-24V AC/DC
SNT-MS74-RGB-30T	M22- Nut, ø70	3Modes, 30cm Tube	12-24V AC/DC
SNT-MS74-B-RGB-30T	M22- Nut, ø70	3Modes, Buzzer, 30cm Tube	12-24V AC/DC



Obstruction Lights



Heavy Duty Lights



Safety Lights



Machine Tool Lights



Motor Sirens



Space Parts



RGB Stack Light

PART NO	LENS DIA.	TYPE	POWER SUPPLY
SNT-T74-RGB	ø70	3Modes	12-24V AC/DC
SNT-T74-B-RGB	ø70	3Modes, Buzzer	12-24V AC/DC
SNT-T72-RGB	ø70	3Modes	40-260V AC/DC
SNT-T72-B-RGB	ø70	3Modes, Buzzer	40-260V AC/DC



RGB Beacon Horn

PART NO	LENS DIA.	TYPE	POWER SUPPLY
SNT-K74-RGB	ø70	3Modes, Buzzer	12-24V AC/DC
SNT-K72-RGB	ø70	3Modes, Buzzer	40-260V AC/DC



Mini RGB Beacon Horn

PART NO	LENS DIA.	TYPE	POWER SUPPLY
SNT-MK74-RGB	ø70	3Modes, Buzzer	12-24V AC/DC
SNT-MK72-RGB	ø70	3Modes, Buzzer	40-260V AC/DC



RGB Led Horn

PART NO	LENS DIA.	TYPE	POWER SUPPLY
SNT-B74-RGB	ø70	3Modes, Buzzer	12-24V AC/DC
SNT-B72-RGB	ø70	3Modes, Buzzer	40-260V AC/DC



Mini RGB Led Horn

PART NO	LENS DIA.	TYPE	POWER SUPPLY
SNT-MB74-RGB	ø70	3Modes, Buzzer	12-24V AC/DC
SNT-MB72-RGB	ø70	3Modes, Buzzer	40-260V AC/DC



Stack Lights



RGB Warning Lights



Signal Beacons



LED Warning Horns

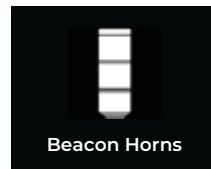

Beacon Horns



Electronic Sirens



90 RGB Signal Beacon

PART NO	LENS DIA.	TYPE	POWER SUPPLY
SNT-915-RGB	ø90	3Modes	12-24V AC/DC
SNT-915-B-RGB	ø90	3Modes, Buzzer	12-24V AC/DC
SNT-925-RGB	ø90	3Modes	40-260V AC/DC
SNT-925-B-RGB	ø90	3Modes, Buzzer	40-260V AC/DC



100 RGB Signal Beacon

PART NO	LENS DIA.	TYPE	POWER SUPPLY
SNT-115-RGB	ø100	3Modes	12-24V AC/DC
SNT-115-B-RGB	ø100	3Modes, Buzzer	12-24V AC/DC
SNT-125-RGB	ø100	3Modes	40-260V AC/DC
SNT-125-B-RGB	ø100	3Modes, Buzzer	40-260V AC/DC



Multicolor RGB - Spare Parts

PART NO	TYPE	COLOR
SNT-M70LNB	Ø70 Mini PC-Lens	Transparent
SNT-YB70LNB	Ø70 PC-Lens	Transparent
SNT-90LNB	Ø90 PC-Lens	Transparent
SNT-100LNB	Ø100 PC-Lens	Transparent
SNT-MRGB70-LNSF	Ø70 Mini PC-Lens	Cloudy
SNT-RGB70-LNSF	Ø70 PC-Lens	Cloudy
SNT-RGB90-LNSF	Ø90 PC-Lens	Cloudy
SNT-RGB100-LNSF	Ø100 PC-Lens	Cloudy
SNT-10U	10cm Metal Extension Tube	Gray
SNT-20U	20cm Metal Extension Tube	Gray
SNT-30U	30cm Metal Extension Tube	Gray
SNT-10RTB	10cm Metal Tube Nut-Connect	Gray-Black
SNT-20RTB	20cm Metal Tube Nut-Connect	Gray-Black
SNT-30RTB	30cm Metal Tube Nut-Connect	Gray-Black
SNT-70TB	ABS Syrface Bracket	Black
SNT-70D	ABS Foldable Base	Black
SNT-70L	ABS Wall Bracket	Black
SNT-72LT	ø 70 Metal Wall Bracket- Nut Con.	Black
SNT-70LT	ø70 Metal Wall Bracket	Black
SNT-90LT	ø90 Metal Wall Bracket	Black
SNT-100LT	ø100 Metal Wall Bracket	Black
SNT-90KFS	ø90 Metal Protection Cage	Black
SNT-100KFS	ø100 Metal Protection Cage	Black









Stack Lights



RGB Warning Lights



Signal Beacons



LED Warning Horns

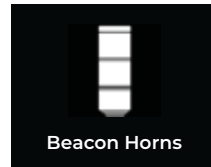

Beacon Horns



Electronic Sirens



i Multifunction beacons offer the advantage that several functions can be covered by a single beacon. If conditions change, the function of the multifunction beacon can be changed quickly and easily and no new signal beacon needs to be purchased. Depending on the model, LED multifunction beacons can display up to 5 operating modes the following functions: Steady, Flashing, Strobe, Rotating light.

- The new series signal is available as a multifunction model in a POWER LED and an SMD LED version. Depending on the model, a different number of LEDs is installed inside. The high performance version is equipped with 5x3W Power LEDs, the other model in the with 45 SMD Leds. Both models can display 5 modes and up to 10tons.
- While the power led version provides light for much longer distances with its angular lightning feature, the SMD led version provides more diffuse light.

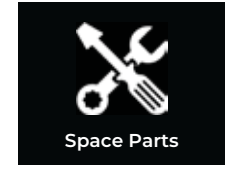

UNIVERSAL SIGNAL BEACONS

The largest and most extensive beacon series in 4 sizes ranging which can be combined with a buzzer indicator.

- Lens: Polycarbonate
- Lens Diameter: 70mm, 90mm, 100mm and 125mm
- LED Module: SMD / POWER
- LED life duration: 50.000 hrs
- Light Colors: Red, Green, Yellow, Blue, White
- Light Modes: Steady, Flashing, Strobing, Rotary
- Sound: 10 melodies
- Volume: 85-110dB
- Sound and Light can be controlled separately
- Housing: ABS
- Mounting Types: Surface & Wall
- Protection Cage against strokes
- Does not affected by water, dust, heat and UV rays
- Warranty: 2 Years

Voltage Options:

- Option 1: 12-24V AC/DC
- Option 2: 85-260V AC/DC
- Option 3: 220V/AC



- Before making electrical connections to the products, please read the user manuals included in the box!
- The connection of the product should be made by at least electric technicians.

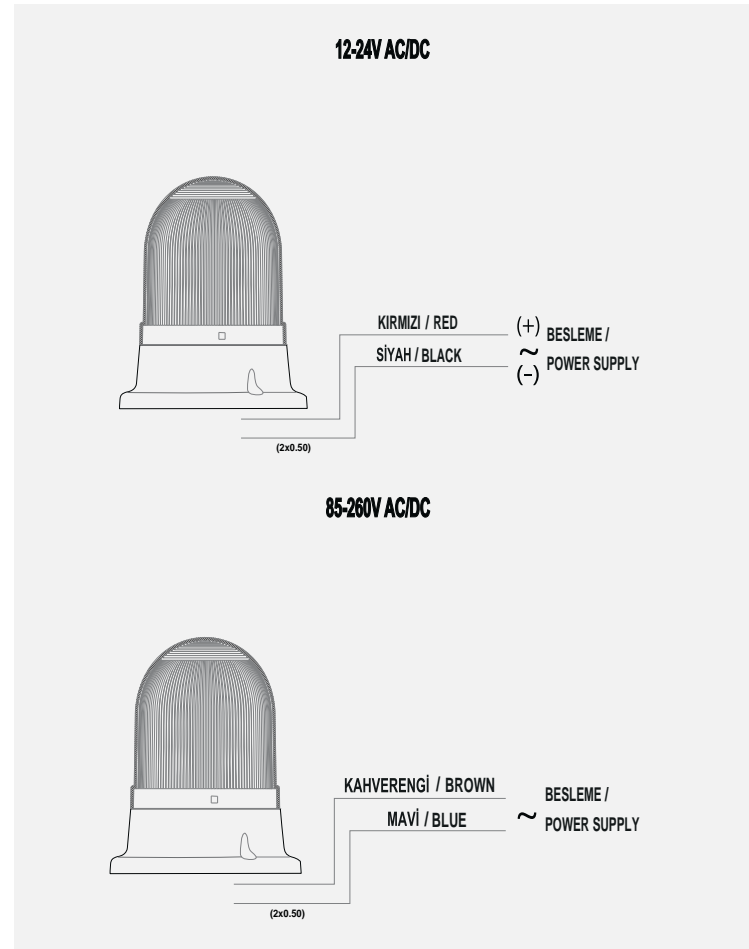

For more Details

Scan the QR Code for more information about the product

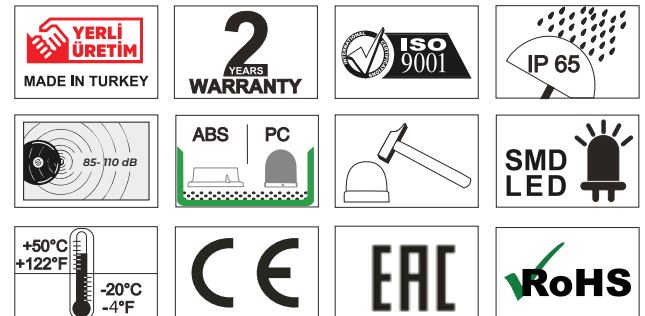



Stack Lights



RGB Warning Lights



Signal Beacons



LED Warning Horns



Beacon Horns



Electronic Sirens



70 Signal Beacon

Voltage Options:

SNT-715-... : 24V/DC

SNT-725-... : 40-260V DC/AC

- LED Module: SMD
- Light Colors: Red, Green, Yellow, Blue, White
- Light Modes: Steady, Flashing
- Sound: 2 melodies
- Volume: 94-100dB
- Mounting Types: Surface & Wall
- Lens Diameter: 70mm

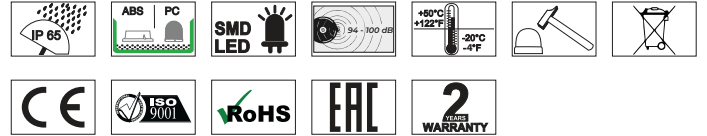

SNT-715-F- **1**

»»» Products Colors



SNT-715-F- **2**



SNT-715-F- **3**



SNT-715-F- **4**



SNT-715-F- **5**

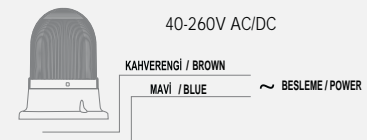
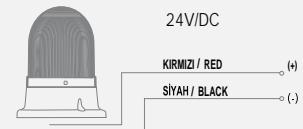
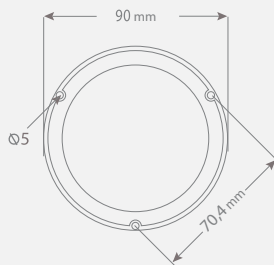
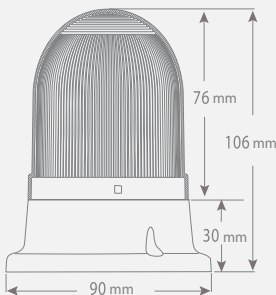



Obstruction Lights



Heavy Duty Lights



Safety Lights



Machine Tool Lights



Motor Sirens



Space Parts



Mini Signal Beacon

Voltage Options:

SNT-M715-... : 24V/DC

SNT-M725-... : 40-260V/AC

- LED Module: SMD
- Light Colors: Red, Green, Yellow, Blue, White
- Light Modes: Steady, Flashing
- Sound: 2 melodies
- Volume: 94-100dB
- Mounting Types: Surface & Wall
- Lens Diameter: 70mm



SNT-M715-F-**1**

»» Products Colors



SNT-M715-F-**2**



SNT-M715-F-**3**



SNT-M715-F-**4**



SNT-M715-F-**5**

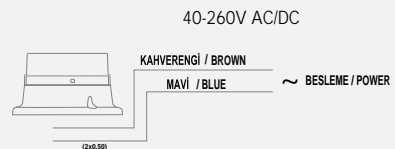
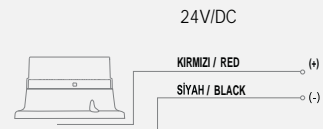
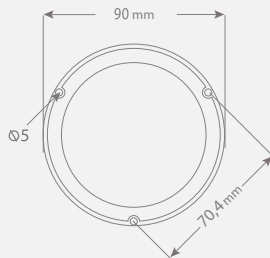
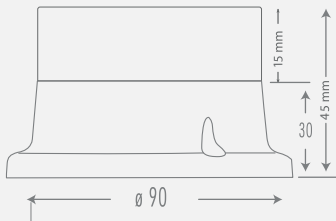



Stack Lights



RGB Warning Lights



Signal Beacons



LED Warning Horns



Beacon Horns



Electronic Sirens

Nut-Connected Signal Beacon

Voltage Options:

SNT-S715-... : 24V/DC

SNT-S725-... : 40-260V/AC

- LED Module: SMD
- Light Colors: Red, Green, Yellow, Blue, White
- Light Modes: Steady, Flashing
- Sound: 2 melodies
- Volume: 104-107dB
- Mounting Types: Surface & Wall
- Lens Diameter: 70mm

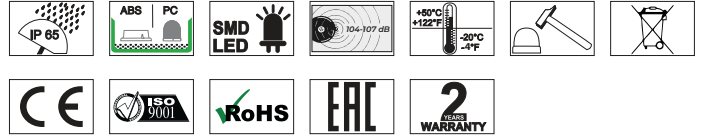

SNT-S715-F-**1**

Product Colors



SNT-S715-F-**2**



SNT-S715-F-**3**-10T



SNT-S715-F-**4**-20T



SNT-S715-F-**5**-30T

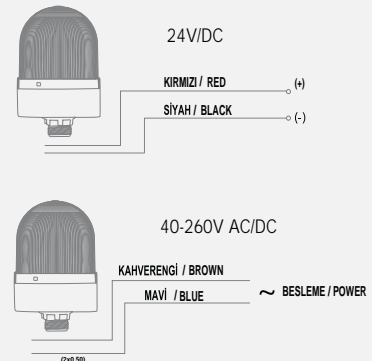
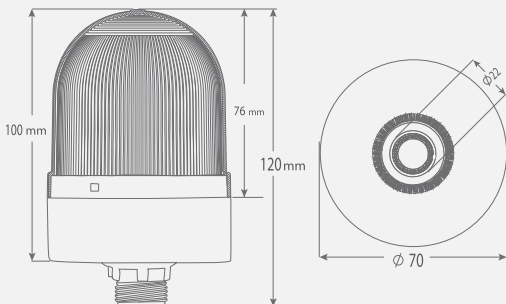



Obstruction Lights



Heavy Duty Lights



Safety Lights



Machine Tool Lights



Motor Sirens

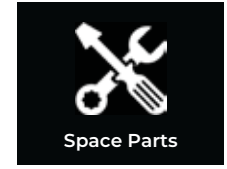

Space Parts

Nut-Connected Mini Signal Beacon

Voltage Options:

SNT-S715-... : 24V/DC

SNT-S725-... : 40-260V/AC

- LED Module: SMD
- Light Colors: Red, Green, Yellow, Blue, White
- Light Modes: Steady, Flashing
- Sound: 2 melodies
- Volume: 104-107dB
- Mounting Types: Surface & Wall
- Lens Diameter: 70mm



SNT-MS715-F-1

Products Colors



SNT-MS715-F-2



SNT-MS715-F-3



SNT-MS715-F-4



SNT-MS715-F-5

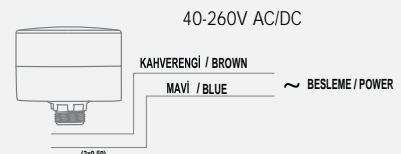
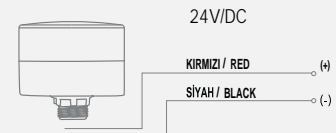
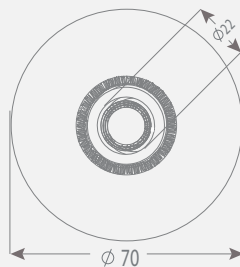
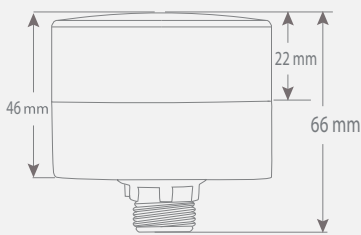



Stack Lights



RGB Warning Lights



Signal Beacons



LED Warning Horns



Beacon Horns



Electronic Sirens



90 Universal Signal Beacon

Voltage Options:

SNT-915-... : 12-24V AC/DC

SNT-925-... : 85-260V AC/DC

Led Module Options:

SNT-910 / SNT-920 : 45 SMD LED

SNT-915 / SNT-925 : 5X3W POWER LED

- LED Module: SMD / POWER
- Light Colors: Red, Green, Yellow, Blue, White
- Light Modes: Steady, Flashing, Strobe, Rotary
- Sound: 10 melodies
- Sound&Light changing button
- Volume: 85-110dB
- Mounting Types: Surface & Wall
- Protection Cage against strokes
- Lens Diameter: 90mm



SNT-915-1



Products Colors



SNT-915-2



SNT-915-KFS-3



SNT-915-4



SNT-915-KFS-5

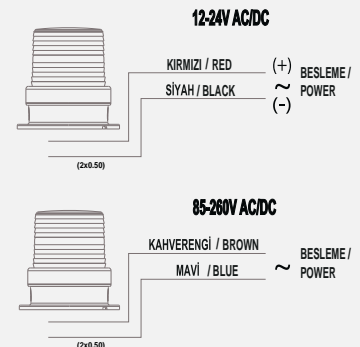
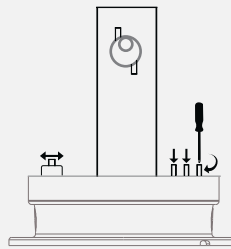
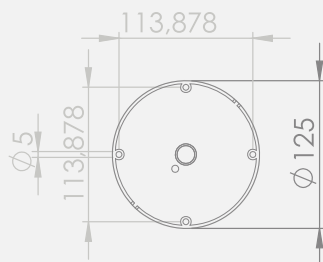
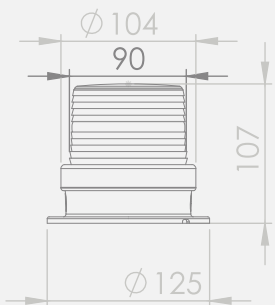



Obstruction Lights



Heavy Duty Lights



Safety Lights



Machine Tool Lights



Motor Sirens

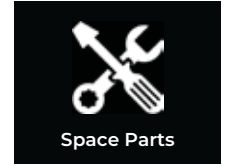

Space Parts



100 Universal Signal Beacon

Voltage Options:

SNT-115-... : 12-24V AC/DC

SNT-125-... : 85-260V AC/DC

Led Module Options:

SNT-110 / SNT-120 : 45 SMD LED

SNT-115 / SNT-125 : 5X3W POWER LED

- LED Module: SMD / POWER
- Light Colors: Red, Green, Yellow, Blue, White
- Light Modes: Steady, Flashing, Strobe, Rotary
- Sound: 10 melodies
- Sound&Light changing button
- Volume: 88-112dB
- Mounting Types: Surface & Wall
- Protection Cage against strokes
- Lens Diameter: 100mm



SNT-115-1



Products Colors



SNT-115-2



SNT-115-KFS-3



SNT-115-4



SNT-115-KFS-5

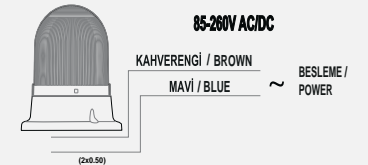
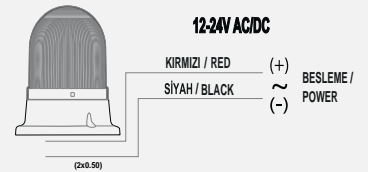
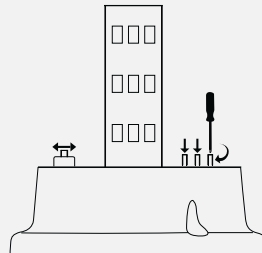
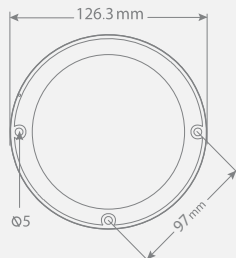
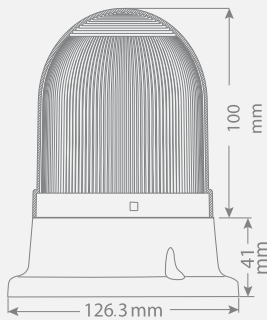



Stack Lights



RGB Warning Lights



Signal Beacons



LED Warning Horns

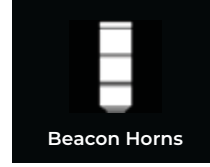

Beacon Horns



Electronic Sirens



125 Universal Signal Beacon

Voltage Options:

SNT-1215-... : 12-24V AC/DC

SNT-1225-... : 85-260V AC/DC

Led Module Options:

SNT-1210 / SNT-1220 : 45 SMD LED

SNT-1215 / SNT-1225 : 5x3W POWER LED

- Light Colors: Red, Green, Yellow, Blue, White
- Light Modes: Steady, Flashing, Strobe, Rotary
- Sound: 10 melodies
- Sound&Light changing button
- Volume: 85-105dB
- Mounting Types: Surface & Wall
- Protection Cage against strokes
- Lens Diameter: 125mm



SNT-1215- **1**



Product Colors



SNT-1215- **2**



SNT-1215- **3**



SNT-1215 **4**



SNT-1215- **5**

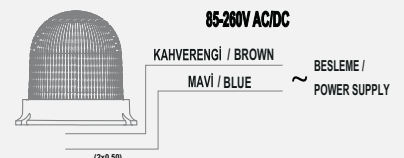
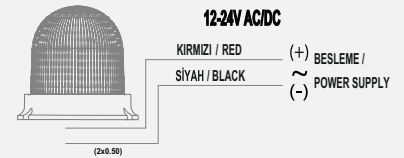
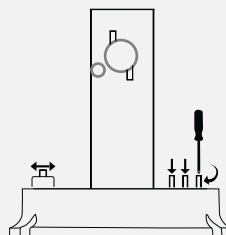
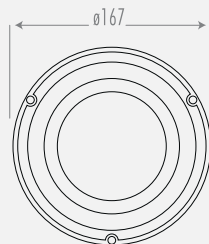
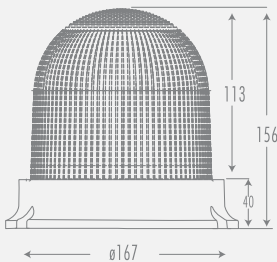



Obstruction Lights



Heavy Duty Lights



Safety Lights



Machine Tool Lights



Motor Sirens

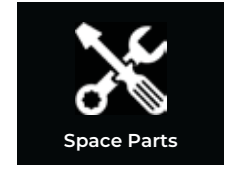

Space Parts



Maxi-Volt Signal Beacon

24-260 V

Maxi Volt Signal Beacons, which offer a wide range of voltage options, are specially produced for forklifts.

- Lens: Polycarbonate
- Lens Diameter: 90mm, 100mm and 125mm
- LED Module: 5x3W POWER
- LED life duration: 50.000 hrs
- Light Colors: Red, Green, Yellow, Blue, White
- Light Modes: Strobing
- Sound: 1 melody
- Volume: 117dB
- Sound and Light can be controlled separately
- Housing: ABS
- Mounting Types: Surface & Wall
- Protection Cage against strokes
- Does not affected by water, dust, heat and UV rays
- Warranty: 2 Years

Voltage Options:

Option 1 (without Buzzer): 24-230V AC/DC

Option 2 (with Buzzer) : 24-90V/DC , 24-60V/AC



SNT-912-2



SNT-912-KFS-3



SNT-112-KFS 4



SNT-1212-5

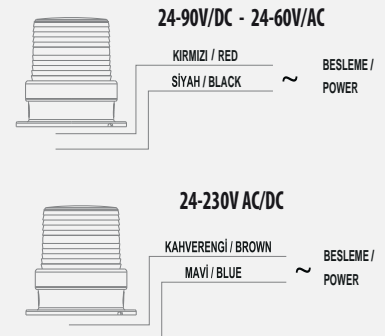
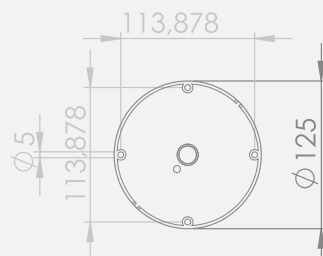
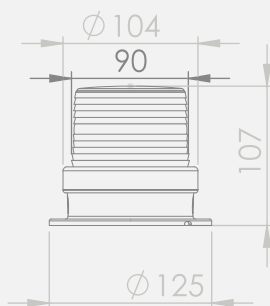



Stack Lights



RGB Warning Lights



Signal Beacons



LED Warning Horns

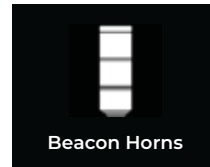

Beacon Horns



Electronic Sirens



Telephone Ring Signal Beacon

Telephone Ring Multifunction Indicators:

Telephone-connected signal beacons are easily integrated into internal lines in noisy working environments, allowing calls to be noticed.

Specifications:

- Lens: Polycarbonate
- Lens Diameter: 90mm & 100mm
- LED Module: 5x3W POWER
- LED life duration: 50.000 hrs
- Light Colors: Red, Green, Yellow, Blue, White
- Light Modes: Steady, Flashing, Strobging, Rotary
- Sound: 10 melodies
- Volume: 85-110dB
- Sound and Light can be controlled separately
- Housing: ABS
- Mounting Types: Surface & Wall
- Protection Cage against strokes
- Does not affected by water, dust, heat and UV rays
- Warranty: 2 Years

Voltage Options:

- Option 1 : 12-24V AC/DC
- Option 2: 85-260V AC/DC



SNT-125-PH-2



SNT-125-PH-KFS-3



SNT-925-PH-4



SNT-925-PH-KFS-5

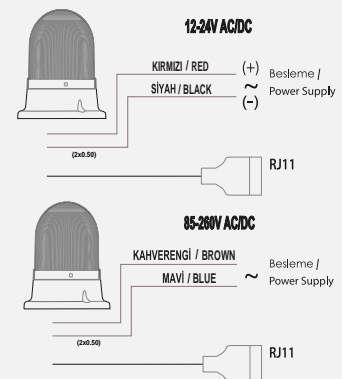
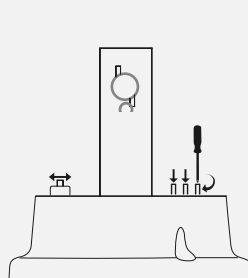
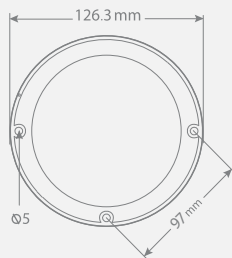
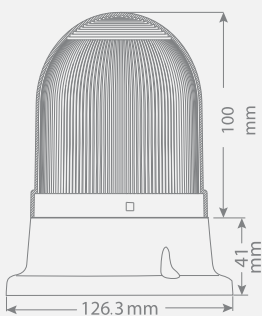



Obstruction Lights



Heavy Duty Lights



Safety Lights



Machine Tool Lights



Motor Sirens



Space Parts



Magnetic Base Signal Beacon with Cigarette Plug

- Lens: Polycarbonate
- Lens Diameter: 90mm
- LED Module: 5x3W POWER
- LED life duration: 50.000 hrs
- Light Colors: Red, Green, Yellow, Blue, White
- Light Modes: Steady, Flashing, Strobing, Rotary
- Sound: 10 melodies (85-110dB)
- Sound and Light can be controlled separately
- Housing: ABS
- Mounting Types: Surface & Wall
- Protection Cage against strokes
- Strong magnet to secure attachment to vehicle surfaces
- Does not affected by water, dust, heat and UV rays
- Warranty: 2 Years

Voltage Options:
SNT-F915-.....: 12-24V AC/DC



SNT-F915-KFS-2



SNT-F915-3



SNT-F915-KFS-4



SNT-F915-5

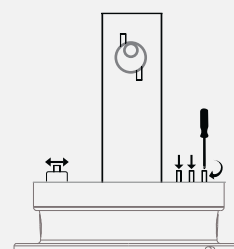
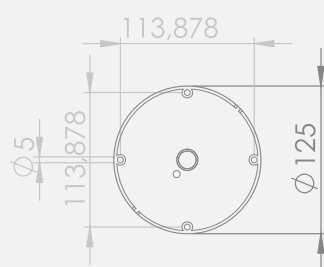
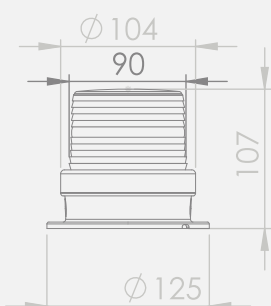



Stack Lights



RGB Warning Lights



Signal Beacons



LED Warning Horns

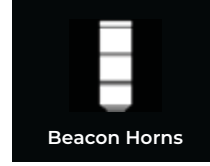

Beacon Horns



Electronic Sirens



Signal Beacon with Sensor

Night-day switching feature



- Lens: Polycarbonate
- LED Module: 5x3W POWER
- LED life duration: 50.000 hrs
- Light Colors: Red, Green, Yellow, Blue, White
- Light Modes: Steady, Flashing, Strobing
- Sound: 10 melodies
- Volume: 85-110dB
- Sound and Light can be controlled separately
- Housing: ABS
- Mounting Types: Surface & Wall
- Protection Cage against strokes
- Lens Diameter: 90mm & 100mm
- Does not affected by water, dust, heat and UV rays
- Warranty: 2 Years

Voltage Options:

Option 1 : 12-24V AC/DC

Option 2: 85-260V AC/DC



SNT-915-ND-2



SNT-915-ND-KFS-3



SNT-915-ND-4



SNT-915-ND-KFS-5

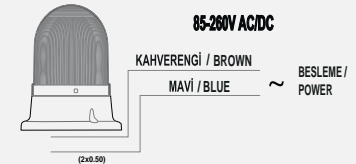
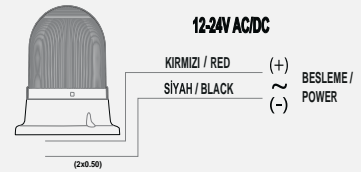
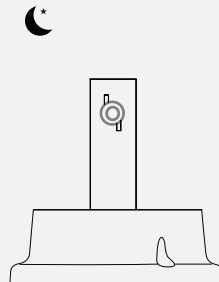
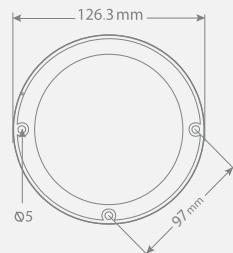
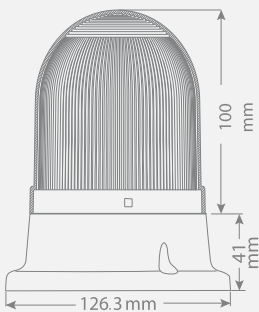



Obstruction Lights



Heavy Duty Lights



Safety Lights



Machine Tool Lights



Motor Sirens



Space Parts

Solar Power Signal Beacon

- Lens: Polycarbonate
- LED life duration: 50,000 hrs
- Light Colors: Red, Yellow
- Light Modes: Flashing
- Housing: ABS
- Mounting Types: Surface & Wall
- Lens Diameter: 90mm
- Does not affected by water, dust, heat and UV rays
- Warranty: 2 Years



!!! For magnetic base inquiries contact the company.

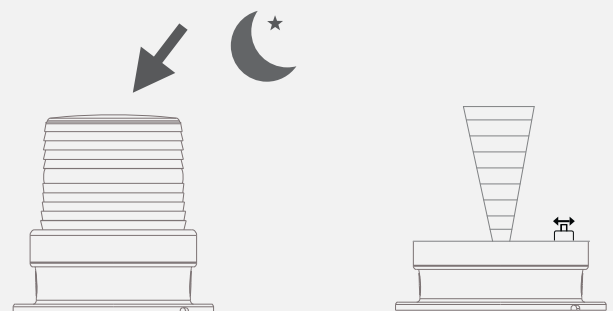
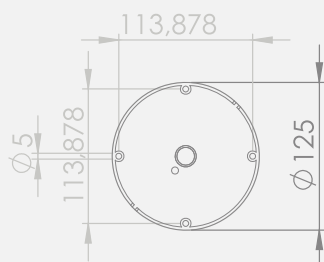
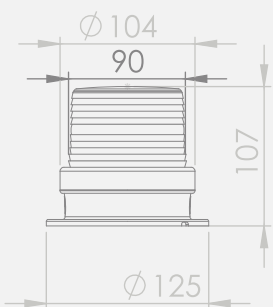
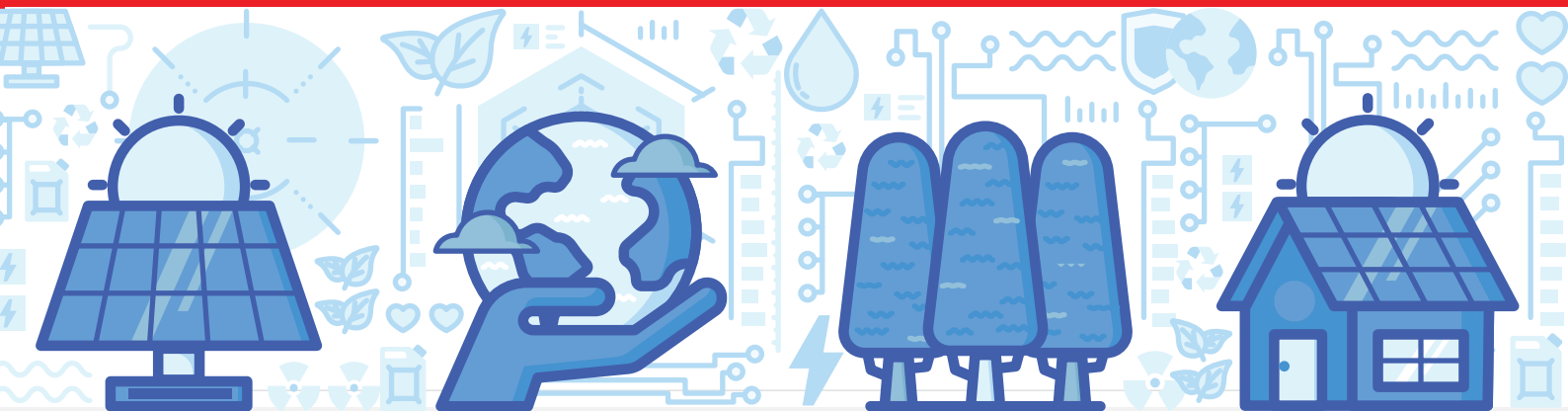



Stack Lights



RGB Warning Lights



Signal Beacons



LED Warning Horns

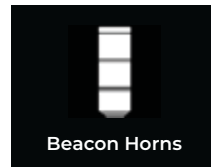

Beacon Horns



Electronic Sirens



Rechargeable Universal Signal Beacon Portable Signal Light

Portable, battery-powered LED warning light.

Battery-powered 5 modes light with a rechargeable battery includes a battery and will run approximately 20 hours between charges.

- Lens: Polycarbonate
- Lens Diameter: 90mm
- LED Module: 5x3W POWER
- LED life duration: 50.000 hrs
- Light Colors: Red, Green, Yellow, Blue, White
- Light Modes: Steady, Flashing, Strobging, Rotary
- Sound: 10 melodies
- Volume: 85-110dB
- Sound and Light can be controlled separately
- Housing: ABS
- Mounting Types: Surface & Portable
- Protection Cage against strokes
- Does not affected by water, dust, heat and UV rays
- Warranty: 2 Years

Power Supply:

Powered by Battery



SNT-915-SRB-2



SNT-915-SRB-3



SNT-915-SRB-4



SNT-915-SRB-5

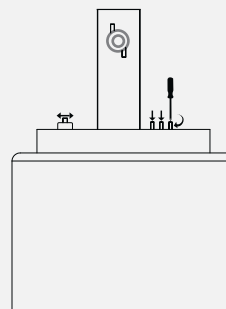
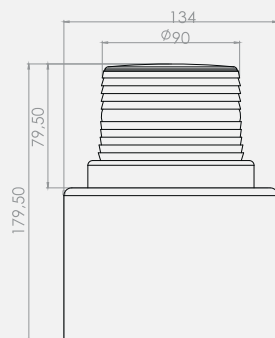

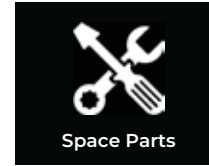

Dual Universal Signal Beacon Multifunction Dual Signal Beacon

- Lens: Polycarbonate
- Lens Diameter: 90mm
- LED Module: 5x3W POWER
- LED life duration: 50.000 hrs
- Light Colors: Red-Green (for other colors contact company)
- Light Modes: Steady, Flashing, Strobing, Rotary
- Sound: 10 melodies
- Volume: 85-110dB
- Sound and Light can be controlled separately
- Housing: ABS
- Mounting Types: Wall
- Protection Cage against strokes
- Does not affected by water, dust, heat and UV rays
- Warranty: 2 Years

Power Supply:
SNT-2X915: 12-24V AC/DC
SNT-2X925: 85-260V AC/DC





Stack Lights



RGB Warning Lights



Signal Beacons



LED Warning Horns

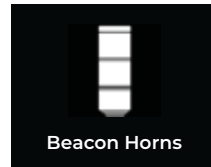

Beacon Horns



Electronic Sirens



70 Signal Beacon

PART NO	LENS DIA.	TYPE	POWER SUPPLY
SNT-715-S-...	ø70	Steady	24V/DC
SNT-725-S-...	ø70	Steady	40-260V AC/DC
SNT-715-F-...	ø70	Flashing	24V/DC
SNT-725-F-...	ø70	Flashing	40-260V AC/DC
SNT-715-SB-...	ø70	Steady-Buzzer	24V/DC
SNT-725-SB-...	ø70	Steady-Buzzer	40-260V AC/DC
SNT-715-FB-...	ø70	Flashing-Buzzer	24V/DC
SNT-725-FB-...	ø70	Flashing-Buzzer	40-260V AC/DC



Mini Signal Beacon

PART NO	LENS DIA.	TYPE	POWER SUPPLY
SNT-M715-S-...	ø70	Steady	24V/DC
SNT-M725-S-...	ø70	Steady	40-260V AC/DC
SNT-M715-F-...	ø70	Flashing	24V/DC
SNT-M725-F-...	ø70	Flashing	40-260V AC/DC
SNT-M715-SB-...	ø70	Steady-Buzzer	24V/DC
SNT-M725-SB-...	ø70	Steady-Buzzer	40-260V AC/DC
SNT-M715-FB-...	ø70	Flashing-Buzzer	24V/DC
SNT-M725-FB-...	ø70	Flashing-Buzzer	40-260V AC/DC



Nut-Connect Signal Beacon

PART NO	LENS DIA.	TYPE	POWER SUPPLY
SNT-S715-S-...	M22- Nut, ø70	Steady	24V/DC
SNT-S725-S-...	M22- Nut, ø70	Steady	40-260V AC/DC
SNT-S715-F-...	M22- Nut, ø70	Flashing	24V/DC
SNT-S725-F-...	M22- Nut, ø70	Flashing	40-260V AC/DC
SNT-S715-SB-...	M22- Nut, ø70	Steady-Buzzer	24V/DC
SNT-S725-SB-...	M22- Nut, ø70	Steady-Buzzer	40-260V AC/DC
SNT-S715-FB-...	M22- Nut, ø70	Flashing-Buzzer	24V/DC
SNT-S725-FB-...	M22- Nut, ø70	Flashing-Buzzer	40-260V AC/DC



!!!! Please specify color codes in your orders.



Nut-Connect Mini Signal Beacon

PART NO	LENS DIA.	TYPE	POWER SUPPLY
SNT-MS715-S-...	M22- Nut, ø70	Steady	24V/DC
SNT-MS725-S-...	M22- Nut, ø70	Steady	40-260V AC/DC
SNT-MS715-F-...	M22- Nut, ø70	Flashing	24V/DC
SNT-MS725-F-...	M22- Nut, ø70	Flashing	40-260V AC/DC
SNT-MS715-SB-...	M22- Nut, ø70	Steady-Buzzer	24V/DC
SNT-MS725-SB-...	M22- Nut, ø70	Steady-Buzzer	40-260V AC/DC
SNT-MS715-FB-...	M22- Nut, ø70	Flashing-Buzzer	24V/DC
SNT-MS725-FB-...	M22- Nut, ø70	Flashing-Buzzer	40-260V AC/DC



90 Universal Signal Beacon

PART NO	LENS DIA.	TYPE	POWER SUPPLY
SNT-910-...	ø90	5Modes, SMD LED	12-24V AC/DC
SNT-920-...	ø90	5Modes, SMD LED	85-260V AC/DC
SNT-910-B-...	ø90	5Modes, SMD LED,Buzzer	12-24V AC/DC
SNT-920-B-...	ø90	5Modes, SMD LED,Buzzer	85-260V AC/DC
SNT-910-KFS-...	ø90	5Modes, SMD LED, Prot.Cage	12-24V AC/DC
SNT-920-KFS-...	ø90	5Modes, SMD LED, Prot.Cage	85-260V AC/DC
SNT-910-B-KFS-...	ø90	5Modes, SMD LED,Buzzer, Prot.Cage	12-24V AC/DC
SNT-920-B--KFS...	ø90	5Modes, SMD LED,Buzzer, Prot.Cage	85-260V AC/DC
SNT-915-...	ø90	5Modes, Power LED	12-24V AC/DC
SNT-925-...	ø90	5Modes, Power LED	85-260V AC/DC
SNT-915-B-...	ø90	5Modes, Power LED,Buzzer	12-24V AC/DC
SNT-925-B-...	ø90	5Modes, Power LED,Buzzer	85-260V AC/DC
SNT-915-KFS-...	ø90	5Modes, Power LED, Prot.Cage	12-24V AC/DC
SNT-925-KFS-...	ø90	5Modes, Power LED, Prot.Cage	85-260V AC/DC
SNT-915-B-KFS-...	ø90	5Modes, Power LED,Buzzer, Prot.Cage	12-24V AC/DC
SNT-925-B-KFS...	ø90	5Modes, Power LED,Buzzer, Prot.Cage	85-260V AC/DC

1 3

!!!! Series SNT-910, SNT-920 have two color options, RED&YELLOW.

1 2 3 4 5

!!!! Please specify color codes in your orders.

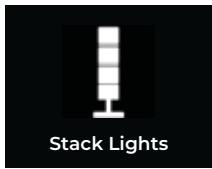

Stack Lights



RGB Warning Lights



Signal Beacons



LED Warning Horns



Beacon Horns



Electronic Sirens



100 Universal Signal Beacon

PART NO	LENS DIA.	TYPE	POWER SUPPLY
SNT-110-...	ø100	5Modes, SMD LED	12-24V AC/DC
SNT-120-...	ø100	5Modes, SMD LED	85-260V AC/DC
SNT-110-B-...	ø100	5Modes, SMD LED, Buzzer	12-24V AC/DC
SNT-120-B-...	ø100	5Modes, SMD LED, Buzzer	85-260V AC/DC
SNT-110-KFS-...	ø100	5Modes, SMD LED, Prot.Cage	12-24V AC/DC
SNT-120-KFS-...	ø100	5Modes, SMD LED, Prot.Cage	85-260V AC/DC
SNT-110-B-KFS-...	ø100	5Modes, SMD LED,Buzzer, Prot.Cage	12-24V AC/DC
SNT-120-B--KFS...	ø100	5Modes, SMD LED,Buzzer, Prot.Cage	85-260V AC/DC
SNT-115-	ø100	5Modes, Power LED	12-24V AC/DC
SNT-125-...	ø100	5Modes, Power LED	85-260V AC/DC
SNT-115-B-...	ø100	5Modes, Power LED, Buzzer	12-24V AC/DC
SNT-125-B-...	ø100	5Modes, Power LED, Buzzer	85-260V AC/DC
SNT-115-KFS-...	ø100	5Modes, Power LED, Prot.Cage	12-24V AC/DC
SNT-125-KFS-...	ø100	5Modes, Power LED, Prot.Cage	85-260V AC/DC
SNT-115-B-KFS-...	ø100	5Modes, Power LED,Buzzer, Prot.Cage	12-24V AC/DC
SNT-125-B-KFS...	ø100	5Modes, Power LED,Buzzer, Prot.Cage	85-260V AC/DC

1 3

!!!! Series SNT-110, SNT-120 have two color options, RED&YELLOW.



125 Universal Signal Beacon

PART NO	LENS DIA.	TYPE	POWER SUPPLY
SNT-1215-...	ø125	5Modes, Power LED	12-24V AC/DC
SNT-1225-...	ø125	5Modes, Power LED	85-260V AC/DC
SNT-1215-B-...	ø125	5Modes, Power LED, Buzzer	12-24V AC/DC
SNT-1225-B-...	ø125	5Modes, Power LED, Buzzer	85-260V AC/DC



Solar Power Signal Beacon

PART NO	LENS DIA.	TYPE	POWER SUPPLY
SNT-915-SL-...	ø90	Flashing	Solar Panel

1 2 3 4 5

!!!! Please specify color codes in your orders.



Maxi-Volt Signal Beacon

PART NO	LENS DIA.	TYPE	POWER SUPPLY
SNT-912-...	ø90	Strobe	24-230V AC/DC
SNT-912-B-...	ø90	Strobe, Buzzer	24-90V DC / 24-60V AC
SNT-912-KFS-...	ø90	Strobe, Prot.Cage	24-230V AC/DC
SNT-912-B-KFS-...	ø90	Strobe, Buzzer, Prot.Cage	24-90V DC / 24-60V AC
SNT-112-...	ø100	Strobe	24-230V AC/DC
SNT-112-B-...	ø100	Strobe, Buzzer	24-90V DC / 24-60V AC
SNT-112-KFS-...	ø100	Strobe, Prot.Cage	24-230V AC/DC
SNT-112-B-KFS-...	ø100	Strobe, Buzzer, Prot.Cage	24-90V DC / 24-60V AC
SNT-1212-...	ø125	Strobe	24-230V AC/DC
SNT-1212-B-...	ø125	Strobe,Buzzer	24-90V DC / 24-60V AC



Signal Beacon with Telephone Relay

PART NO	LENS DIA.	TYPE	POWER SUPPLY
SNT-915-PH-...	ø90	5Modes, Power LED, Buzzer	12-24V AC/DC
SNT-925-PH-...	ø90	5Modes, Power LED, Buzzer	85-260V AC/DC
SNT-915-PH-KFS-...	ø90	5Modes, Power LED, Buzzer, Prot.Cage	12-24V AC/DC
SNT-925-PH-KFS-...	ø90	5Modes, Power LED, Buzzer, Prot.Cage	85-260V AC/DC
SNT-115-PH-...	ø100	5Modes, Power LED, Buzzer	12-24V AC/DC
SNT-125-PH-...	ø100	5Modes, Power LED, Buzzer	85-260V AC/DC
SNT-115-PH-KFS-...	ø100	5Modes, Power LED, Buzzer, Prot.Cage	12-24V AC/DC
SNT-125-PH-KFS-...	ø100	5Modes, Power LED, Buzzer, Prot.Cage	85-260V AC/DC



Rechargeable Universal Signal Beacon

PART NO	LENS DIA.	TYPE	POWER SUPPLY
SNT-915-SRB-...	ø90	5Modes, Power LED, Buzzer	Battery Power



Stack Lights



RGB Warning Lights



Signal Beacons



LED Warning Horns

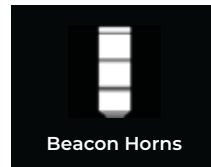

Beacon Horns



Electronic Sirens



Signal Beacon with Sensor

PART NO	LENS DIA.	TYPE	POWER SUPPLY
SNT-915-ND-...	ø90	Power LED	12-24V AC/DC
SNT-925-ND-...	ø90	Power LED	85-260V AC/DC
SNT-915-B-ND-...	ø90	Power LED, Buzzer	12-24V AC/DC
SNT-925-B-ND-...	ø90	Power LED, Buzzer	85-260V AC/DC
SNT-915-ND-KFS...	ø90	Power LED, Prot.Cage	12-24V AC/DC
SNT-925-ND-KFS...	ø90	Power LED, Prot.Cage	85-260V AC/DC
SNT-915-B-ND-KFS...	ø90	Power LED, Buzzer, Prot.Cage	12-24V AC/DC
SNT-925-B-ND-KFS...	ø90	Power LED, Buzzer, Prot.Cage	85-260V AC/DC
SNT-115-ND-...	ø100	Power LED	12-24V AC/DC
SNT-125-ND-...	ø100	Power LED	85-260V AC/DC
SNT-115-B-ND-...	ø100	Power LED, Buzzer	12-24V AC/DC
SNT-125-B-ND-...	ø100	Power LED, Buzzer	85-260V AC/DC
SNT-115-ND-KFS...	ø100	Power LED, Prot.Cage	12-24V AC/DC
SNT-125-ND-KFS...	ø100	Power LED, Prot.Cage	85-260V AC/DC
SNT-115-B-ND-KFS...	ø100	Power LED, Buzzer, Prot.Cage	12-24V AC/DC
SNT-125-B-ND-KFS...	ø100	Power LED, Buzzer, Prot.Cage	85-260V AC/DC



Dual Universal Signal Beacon

PART NO	LENS DIA.	TYPE	POWER SUPPLY
SNT-2X915	ø90	5Modes, Power LED	12-24V AC/DC
SNT-2X925	ø90	5Modes, Power LED	85-260V AC/DC
SNT-2X915-B	ø90	5Modes, Power LED, Buzzer	12-24V AC/DC
SNT-2X925-B	ø90	5Modes, Power LED, Buzzer	85-260V AC/DC
SNT-2X915-KFS	ø90	5Modes, Power LED, Prot.Cage	12-24V AC/DC
SNT-2X925-KFS	ø90	5Modes, Power LED, Prot.Cage	85-260V AC/DC
SNT-2X915-B-KFS	ø90	5Modes, Power LED, Buzzer, Prot.Cage	12-24V AC/DC
SNT-2X925-B-KFS	ø90	5Modes, Power LED, Buzzer, Prot.Cage	85-260V AC/DC

!!!! Series SNT-2X... is produced with in Red-Green colors. For non standard color choices contact the company.



!!!! Please specify color codes in your orders.



Magnetic Base Signal Beacon with Cigarette Lighter

PART NO	LENS DIA.	TYPE	POWER SUPPLY
SNT-F915-...	ø90	Strobe, Power LED	12-24V AC/DC
SNT-F915-B-...	ø90	Strobe, Power LED, Buzzer	12-24V AC/DC
SNT-F915-KFS-...	ø90	Strobe, Power LED, Prot.Cage	12-24V AC/DC
SNT-F915-B-KFS-...	ø100	Strobe, Power LED, Buzzer, Prot.Cage	12-24V AC/DC



Universal Signal Beacons - Lens

PART NO	TYPE	COLOR
SNT-M70-LNK	Ø70 Mini PC-Lens	Red
SNT-M70-LNY	Ø70 Mini PC-Lens	Green
SNT-M70-LNS	Ø70 Mini PC-Lens	Yellow
SNT-M70-LNM	Ø70 Mini PC-Lens	Blue
SNT-M70-LNB	Ø70 Mini PC-Lens	Transparent
SNT-YB70LNK	Ø70 PC-Lens	Red
SNT-YB70LNY	Ø70 PC-Lens	Green
SNT-YB70LNS	Ø70 PC-Lens	Yellow
SNT-YB70LNM	Ø70 PC-Lens	Blue
SNT-YB70LNB	Ø70 PC-Lens	Transparent
SNT-90LNK	Ø90 PC-Lens	Red
SNT-90LNY	Ø90 PC-Lens	Green
SNT-90LNS	Ø90 PC-Lens	Yellow
SNT-90LNM	Ø90 PC-Lens	Blue
SNT-90LNB	Ø90 PC-Lens	Transparent
SNT-100LNK	Ø100 PC-Lens	Red
SNT-100LNY	Ø100 PC-Lens	Green
SNT-100LNS	Ø100 PC-Lens	Yellow
SNT-100LNM	Ø100 PC-Lens	Blue
SNT-100LNB	Ø100 PC-Lens	Transparent
SNT-125LNK	Ø125 PC-Lens	Red
SNT-125LNY	Ø125 PC-Lens	Green
SNT-125LNS	Ø125 PC-Lens	Yellow
SNT-125LNM	Ø125 PC-Lens	Blue
SNT-125LNB	Ø125 PC-Lens	Transparent



Obstruction Lights



Heavy Duty Lights



Safety Lights



Machine Tool Lights



Motor Sirens



Space Parts



Universal Signal Beacons - Mounting Spare Parts

PART NO	TYPE	COLOR
SNT-10RTB	10cm Metal Tube Nut-Connect	Gray-Black
SNT-20RTB	20cm Metal Tube Nut-Connect	Gray-Black
SNT-30RTB	30cm Metal Tube Nut-Connect	Gray-Black
SNT-72LT	ø 70 Metal Wall Bracket- Nut Con.	Black
SNT-70LT	ø70 Metal Wall Bracket	Black
SNT-90LT	ø90 Metal Wall Bracket	Black
SNT-100LT	ø100 Metal Wall Bracket	Black
SNT-125LT	ø125 Metal Wall Bracket	Black
SNT-90KFS	ø90 Metal Protection Cage	Black
SNT-100KFS	ø100 Metal Protection Cage	Black



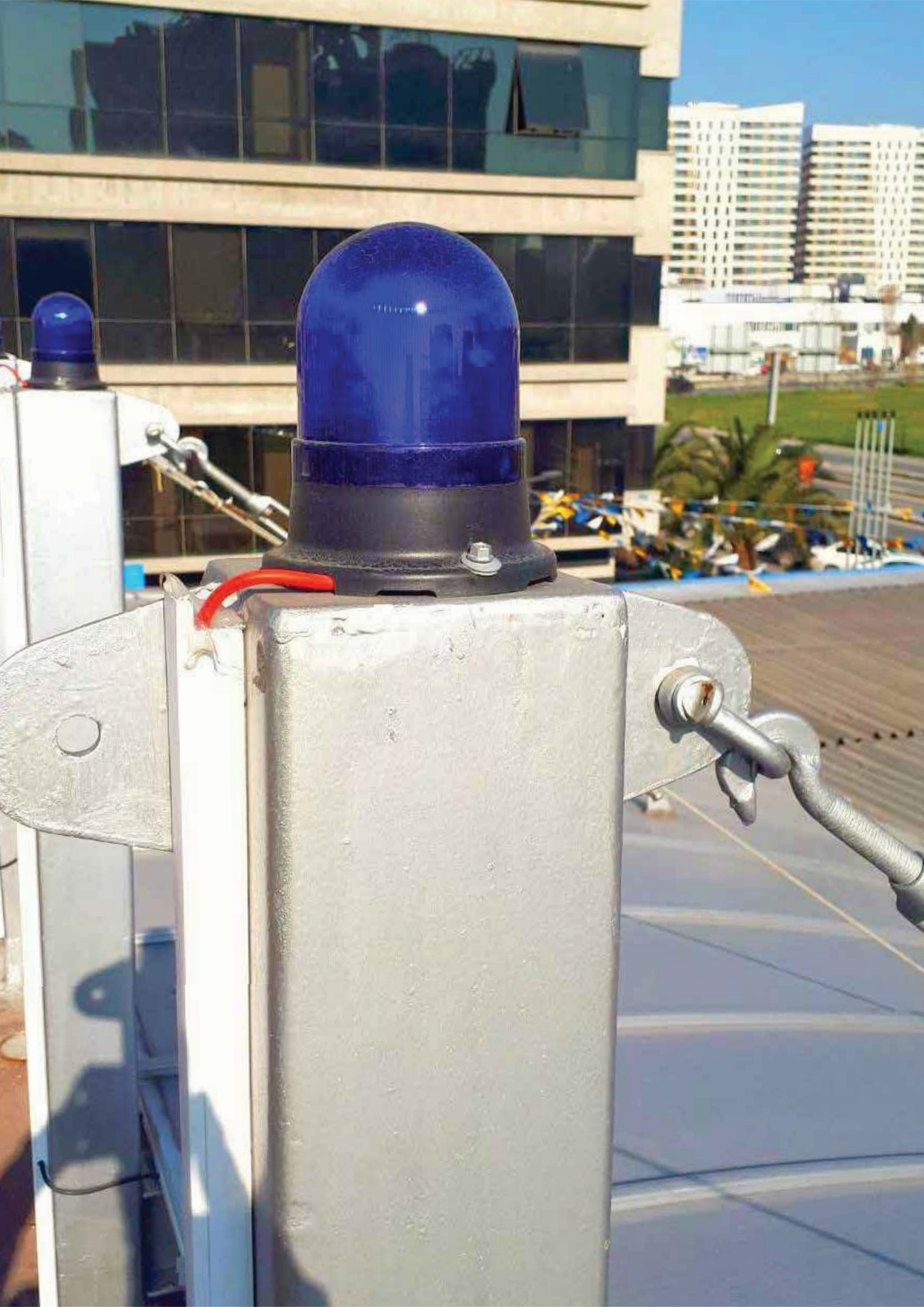







Stack Lights



RGB Warning Lights



Signal Beacons



LED Warning Horns

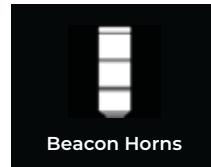

Beacon Horns

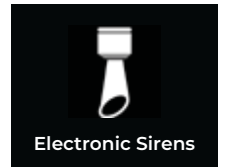

Electronic Sirens



Impact Resistant Polycarbonate Lens

Potentiometer Adjustment of Sound

SMD LED Super Bright

Button Control Melody and Light Mode Control

IP65 Protection Rate

ABS Housing



- Combination of an audible and visual Led Horns are among the products that stand out with their loud sound among warning lamps. It is among the products recommended for use in areas such as cranes, mines, ports, ships, weaving machines, etc.
- You can use led horns for audible and visual warnings in various industries such as mechanical engineering, production automation, automotive factories, warehouses, panels, and electronic control panels.
- Depending on the characteristics of the various models of Mucco Led Horns comes with 2,7 and 16 different tones of options up to 130dB.



UNIVERSAL LED HORNS

Multi-sound with Multi-light LED Horns offers a perfect combination for the highest signaling and alerting.

- Lens: Polycarbonate
- Lens Diameter: 70mm
- LED Module: SMD
- LED life duration: 50.000 hrs
- Light Colors: Red, Green, Yellow, Blue, White
- Light Modes: Steady, Flashing, Strobing, Rotary
- Sound: 16 melodies
- Volume: 124-130dB
- Sound and Light can be controlled separately
- Housing: ABS
- Mounting Types: Wall
- Does not affected by water, dust, heat and UV rays
- Warranty: 2 Years

Voltage Options:

- Option 1: 12-24V AC/DC
- Option 2: 40-260V AC/DC
- Option 3: 24V AC/DC
- Option 4: 220V/AC

For more Details

Scan the QR Code for more information about the product



- Before making electrical connections to the products, please read the user manuals included in the box!
- Do not energize signal and contact cables other than the power cable (2x0.50mm).
- The product is out of warranty when the signal and contact cables are energized.
- The connection of the product should be made by at least electric technicians.

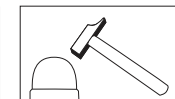
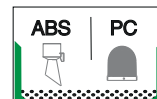
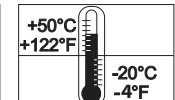
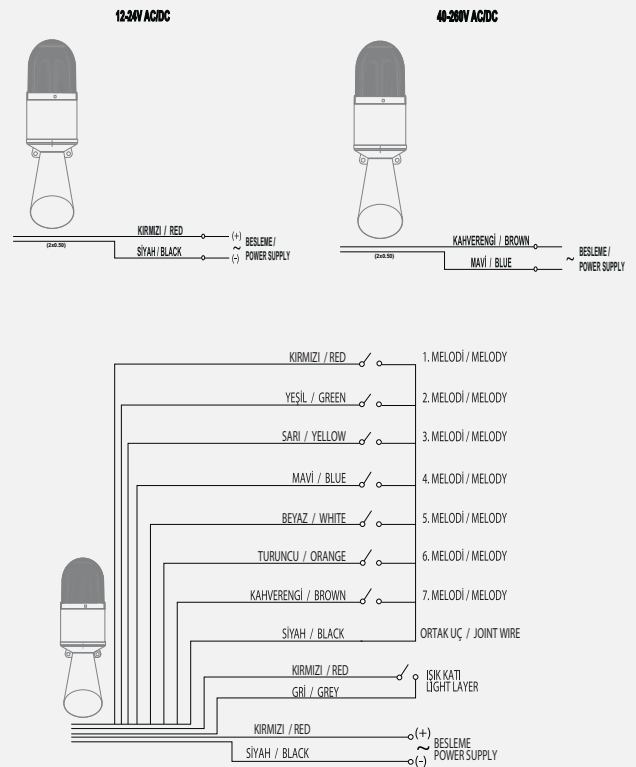



Stack Lights



RGB Warning Lights



Signal Beacons



LED Warning Horns



Beacon Horns



Electronic Sirens



Universal Led Horns

SNT-B71 Series Led Horns

Voltage Options:

SNT-B711-... : 12-24V AC/DC

SNT-B712-... : 40-260V AC/DC

Lens Diameter: 70mm

LED Module: SMD

Light Colors: Red, Green, Yellow, Blue, White

Light Modes: Steady, Flashing, Strobing

Sound: 16 melodies

Volume: 124-130dB

Mounting Types: Wall



SNT-B712-1

Products Colors



SNT-B712-2



SNT-B712-3



SNT-B712 4



SNT-B712-5

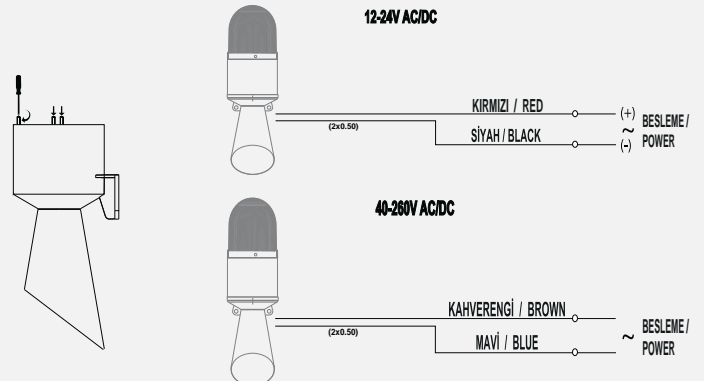
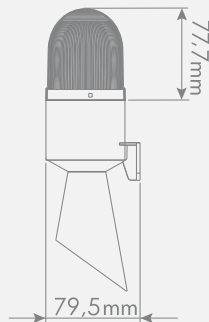
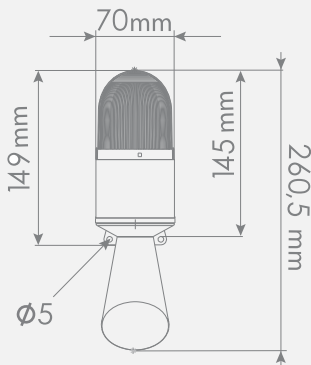



Mini Universal Led Horns

SNT-MB71 Series Led Horns

Voltage Options:

SNT-MB711-... : 12-24V AC/DC

SNT-MB712-... : 40-260V AC/DC

Lens Diameter: 70mm

LED Module: SMD

Light Colors: Red, Green, Yellow, Blue, White

Light Modes: Steady, Flashing, Strobing

Sound: 16 melodies

Volume: 124-130dB

Mounting Types: Wall



SNT-MB712-1

Products Colors



SNT-MB712-2



SNT-MB712-3



SNT-MB712-4



SNT-MB712-5

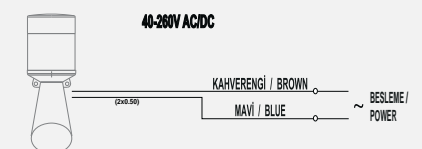
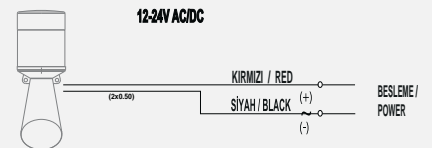
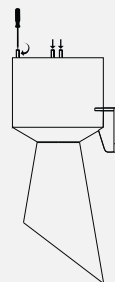
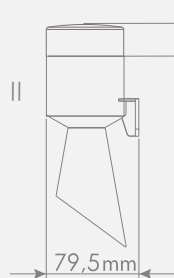
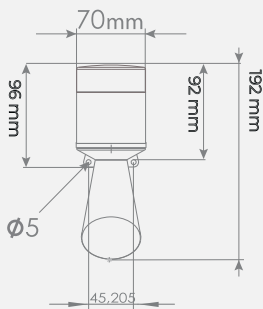



Stack Lights



RGB Warning Lights



Signal Beacons



LED Warning Horns

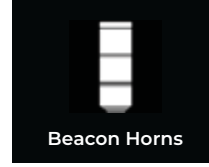

Beacon Horns



Electronic Sirens



Industrial Crane Horns SNT-EB70 Series Led Horns

Lens Diameter: 70mm
LED Module: SMD
Light Colors: Red, Green, Yellow, Blue, White
Light Modes: Steady, Flashing, Strobing, Rotary
Sound: 7 melodies
Volume: 124-130dB
Mounting Types: Wall

7 Different melodies for 7 ignition inputs



Pressing 3 buttons at the same time gives a wrong use alarm sound!!!!

Voltage Options:

SNT-EB7013-... : 12-24V AC/DC
SNT-EB7022-... : 40-260V AC/DC



Products Colors



SNT-EB7013-F1-2



SNT-EB7013-F1-3



SNT-EB7013-F1-4



SNT-EB7013-F1-5

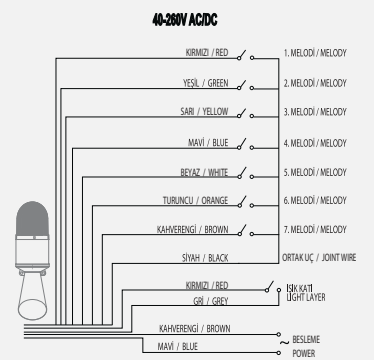
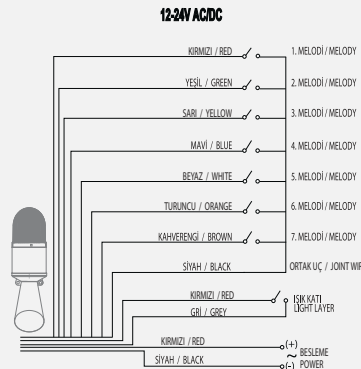
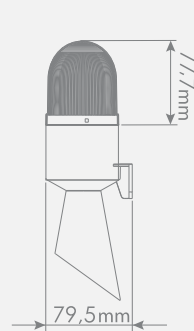
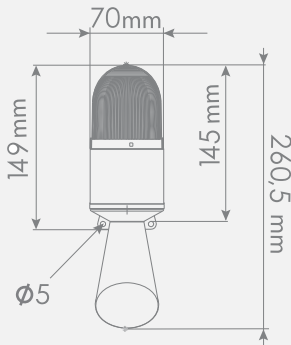



Led Horns

SNT-B710/B720 Series Led Horns

Voltage Options:

SNT-B710-1: 24V AC/DC

SNT-B720-2: 220V/AC

Lens Diameter: 70mm

LED Module: SMD

Light Colors: **Red**

Light Modes: Steady, Flashing

Sound: 2 melodies

Volume: 120-125dB

Mounting Types: Wall

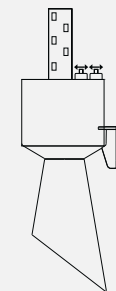
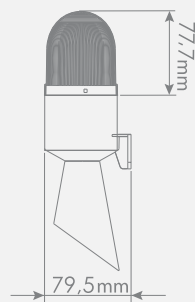
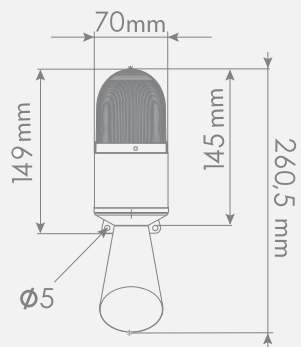
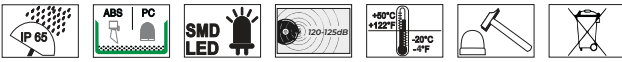

SNT-B710

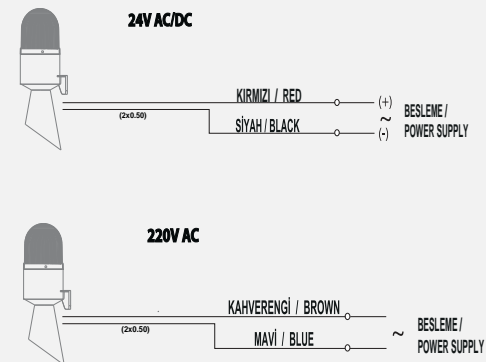

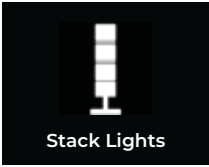

Stack Lights



RGB Warning Lights



Signal Beacons



LED Warning Horns



Beacon Horns



Electronic Sirens



Dry Contact Led Horns

SNT-B70 Series Led Horns with 1 Layer

Voltage Options:

SNT-B7013-... : 12-24V AC/DC

SNT-B7022-... : 40-260V AC/DC

Light Mode Options:

SNT-B70...-F1-... : Steady-Flashing

SNT-B70...-C1-... : Strobe

SNT-B70...-D1-... : Rotary

Lens Diameter: 70mm

LED Module: SMD

Light Colors: Red, Green, Yellow, Blue, White

Sound: 2 melodies

Volume: 120dB

Mounting Types: Wall



SNT-B7013-F1-1



Products Colors



SNT-B7013-F1-2



SNT-B7013-F1-3



SNT-B7013-F1-4



SNT-B7013-F1-5

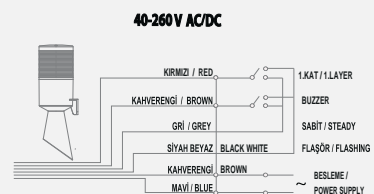
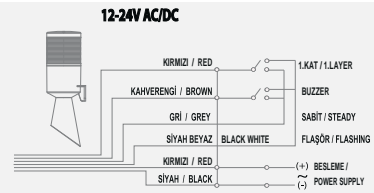
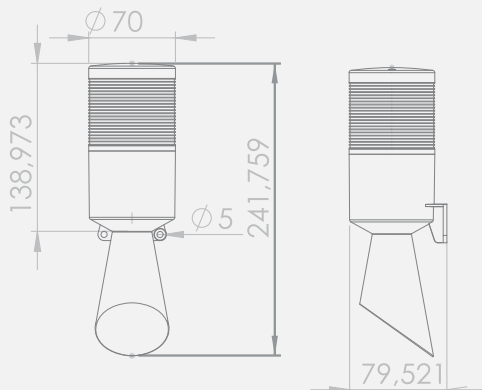

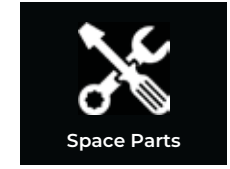

Dry Contact Led Horns

SNT-B70 Series Led Horns with 2 Layer

Voltage Options:

SNT-B7013-... : 12-24V AC/DC
SNT-B7022-... : 40-260V AC/DC

Light Mode Options:

SNT-B70...-F2: Steady-Flashing
SNT-B70...-C2: Strobe
SNT-B70...-D2: Rotary

Lens Diameter: 70mm
LED Module: SMD
Light Colors: Red-Green
Sound: 2 melodies
Volume: 120dB
Mounting Types: Wall



Dry Contact Led Horns

SNT-B70 Series Led Horns with 3 Layer

Voltage Options:

SNT-B7013-... : 12-24V AC/DC
SNT-B7022-... : 40-260V AC/DC

Light Mode Options:

SNT-B70...-F3: Steady-Flashing
SNT-B70...-C3: Strobe
SNT-B70...-D3: Rotary

Lens Diameter: 70mm
LED Module: SMD
Light Colors: Red-Green-Yellow
Sound: 2 melodies
Volume: 120dB
Mounting Types: Wall

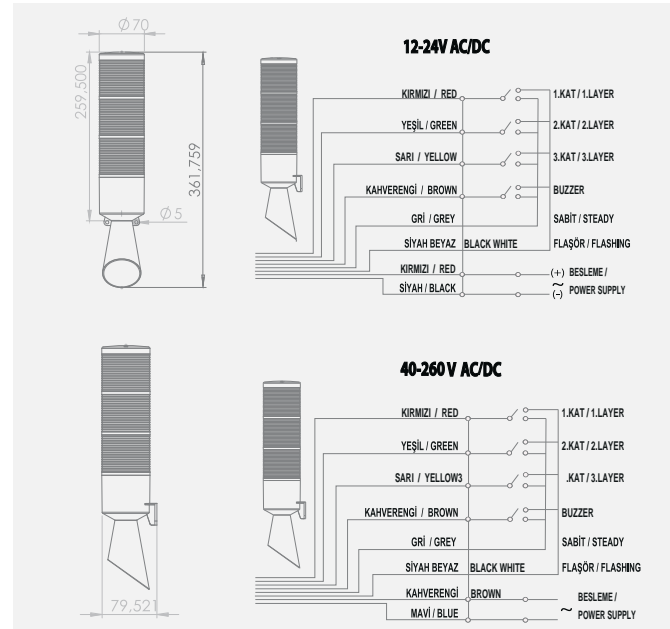
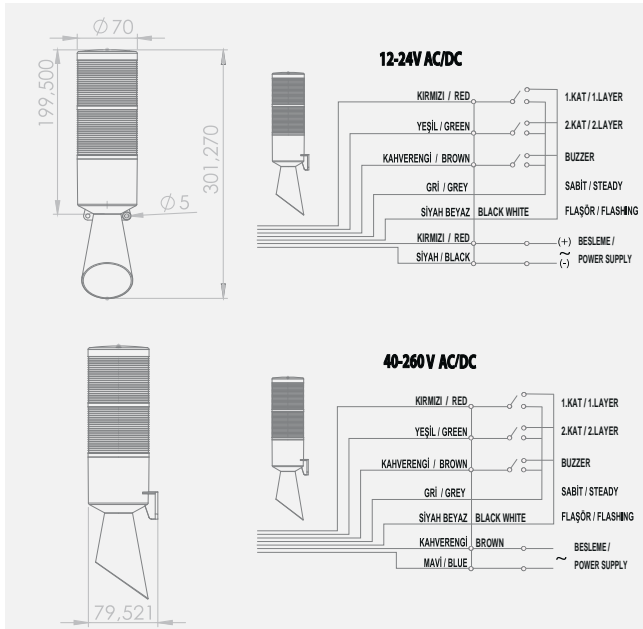



Stack Lights



RGB Warning Lights



Signal Beacons



LED Warning Horns

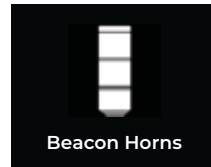

Beacon Horns



Electronic Sirens



Led Horns

PART NO	LENS DIA.	TYPE	POWER SUPPLY
SNT-B710-1	ø70	2Modes, SMD LED, Red	24V AC/DC
SNT-B720-1	ø70	2Modes, SMD LED, Red	220V/AC

1 !!!!! Series SNT-K710, SNT-K720 are sold as a set containing 25pcs and have only one color option, RED.



Universal Led Horns

PART NO	LENS DIA.	TYPE	POWER SUPPLY
SNT-B711-...	ø70	3Modes, SMD LED	12-24V AC/DC
SNT-B712-...	ø70	3Modes, SMD LED	40-260V AC/DC



Mini Universal Led Horns

PART NO	LENS DIA.	TYPE	POWER SUPPLY
SNT-MB711-...	ø70	3Modes, SMD LED	12-24V AC/DC
SNT-MB712-...	ø70	3Modes, SMD LED	40-260V AC/DC



Industrial Crane Horns

PART NO	LENS DIA.	TYPE	POWER SUPPLY
SNT-EB7013-S1-...	ø70	Steady, SMD LED	12-24V AC/DC
SNT-EB7022-S1-...	ø70	Steady, SMD LED	40-260V AC/DC
SNT-EB7013-F1-...	ø70	Flashing, SMD LED	12-24V AC/DC
SNT-EB7022-F1-...	ø70	Flashing, SMD LED	40-260V AC/DC
SNT-EB7013-C1-...	ø70	Strobe, SMD LED	12-24V AC/DC
SNT-EB7022-C1-...	ø70	Strobe, SMD LED	40-260V AC/DC
SNT-EB7013-D1-...	ø70	Rotary, SMD LED	12-24V AC/DC
SNT-EB7022-D1-...	ø70	Rotary, SMD LED	40-260V AC/DC

1 2 3 4 5

!!!! Please specify color codes in your orders.



Dry Contact Led Horns with 1 Layer

PART NO	LENS DIA.	TYPE	POWER SUPPLY
SNT-B7013-F1-...	ø70	Flashing-Steady, SMD LED	12-24V AC/DC
SNT-B7022-F1-...	ø70	Flashing-Steady, SMD LED	40-260V AC/DC
SNT-B7013-C1-...	ø70	Strobe, SMD LED	12-24V AC/DC
SNT-B7022-C1-...	ø70	Strobe, SMD LED	40-260V AC/DC
SNT-B7013-D1-...	ø70	Rotary, SMD LED	12-24V AC/DC
SNT-B7022-D1-...	ø70	Rotary, SMD LED	40-260V AC/DC



!!!! Light codes must be indicated on one layer Dry Contact Led Horns.



Dry Contact Led Horns with 2 Layer

PART NO	LENS DIA.	TYPE	POWER SUPPLY
SNT-B7013-F2	ø70	Flashing-Steady, SMD LED	12-24V AC/DC
SNT-B7022-F2	ø70	Flashing-Steady, SMD LED	40-260V AC/DC
SNT-B7013-C2	ø70	Strobe, SMD LED	12-24V AC/DC
SNT-B7022-C2	ø70	Strobe, SMD LED	40-260V AC/DC
SNT-B7013-D2	ø70	Rotary, SMD LED	12-24V AC/DC
SNT-B7022-D2	ø70	Rotary, SMD LED	40-260V AC/DC

!!!! Standard Color Range; Red-Green For non stand color range contact company.



Dry Contact Led Horns with 3 Layer

PART NO	LENS DIA.	TYPE	POWER SUPPLY
SNT-B7013-F3	ø70	Flashing-Steady, SMD LED	12-24V AC/DC
SNT-B7022-F3	ø70	Flashing-Steady, SMD LED	40-260V AC/DC
SNT-B7013-C3	ø70	Strobe, SMD LED	12-24V AC/DC
SNT-B7022-C3	ø70	Strobe, SMD LED	40-260V AC/DC
SNT-B7013-D3	ø70	Rotary, SMD LED	12-24V AC/DC
SNT-B7022-D3	ø70	Rotary, SMD LED	40-260V AC/DC

!!!! Standard Color Range; Red-Green-Yellow For non stand color range contact company.

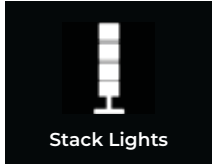

Stack Lights



RGB Warning Lights



Signal Beacons



LED Warning Horns



Beacon Horns



Electronic Sirens



Lens

PART NO	TYPE	CATEGORY	COLOR
SNT-M70-LNK	Ø70 Mini PC-Lens	Mini Series	Red
SNT-M70-LNY	Ø70 Mini PC-Lens	Mini Series	Green
SNT-M70-LNS	Ø70 Mini PC-Lens	Mini Series	Yellow
SNT-M70-LNM	Ø70 Mini PC-Lens	Mini Series	Blue
SNT-M70-LNB	Ø70 Mini PC-Lens	Mini Series	Transparent
SNT-YB70LNK	Ø70 PC-Lens	Led Horn	Red
SNT-YB70LNY	Ø70 PC-Lens	Led Horn	Green
SNT-YB70LNS	Ø70 PC-Lens	Led Horn	Yellow
SNT-YB70LNM	Ø70 PC-Lens	Led Horn	Blue
SNT-YB70LNB	Ø70 PC-Lens	Led Horn	Transparent
SNT-70LNK	Ø70 PC-Lens	Dry Contact Series	Red
SNT-70LNY	Ø70 PC-Lens	Dry Contact Series	Green
SNT-70LNS	Ø70 PC-Lens	Dry Contact Series	Yellow
SNT-70LNM	Ø70 PC-Lens	Dry Contact Series	Blue
SNT-70LNB	Ø70 PC-Lens	Dry Contact Series	Transparent
SNT-70KPK	Ø70 PC-Lens Cover	Dry Contact Series	Red
SNT-70KPY	Ø70 PC-Lens Cover	Dry Contact Series	Green
SNT-70KPS	Ø70 PC-Lens Cover	Dry Contact Series	Yellow
SNT-70KPM	Ø70 PC-Lens Cover	Dry Contact Series	Blue
SNT-70KPB	Ø70 PC-Lens Cover	Dry Contact Series	Transparent





MUCCO
WARNING LAMP
MADE IN TURKEY





Stack Lights



RGB Warning Lights



Signal Beacons



LED Warning Horns

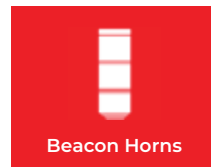

Beacon Horns



Electronic Sirens



- Combination of an audible and visual Beacon Horns are among the products that stand out with their loud sound among warning lamps. It is among the products recommended for use in areas such as cranes, mines, ports, ships, weaving machines, etc.
- You can use beacon horns for audible and visual warnings in various industries such as mechanical engineering, production automation, automotive factories, warehouses, panels, and electronic control panels.
- Depending on the characteristics of the various models of Mucco Beacon Horns comes with 2,7 and 16 different tones of options up to 130dB.



UNIVERSAL BEACON HORNS

Multi-sound with Multi-light BEACON Horns offers a perfect combination for the highest signaling and alerting.

- Lens: Polycarbonate
- Lens Diameter: 70mm
- LED Module: SMD
- LED life duration: 50.000 hrs
- Light Colors: Red, Green, Yellow, Blue, White
- Light Modes: Steady, Flashing, Strobing, Rotary
- Sound: 16 melodies
- Volume: 124-130dB
- Sound and Light can be controlled separately
- Housing: ABS
- Mounting Types: Wall
- Does not affected by water, dust, heat and UV rays
- Warranty: 2 Years

Voltage Options:

- Option 1: 12-24V AC/DC
- Option 2: 40-260V AC/DC
- Option 3: 24V AC/DC
- Option 4: 220V/AC



- Before making electrical connections to the products, please read the user manuals included in the box!
- Do not energize signal and contact cables other than the power cable (2x0.50mm).
- The product is out of warranty when the signal and contact cables are energized.

The connection of the product should be made by at least electric technicians.

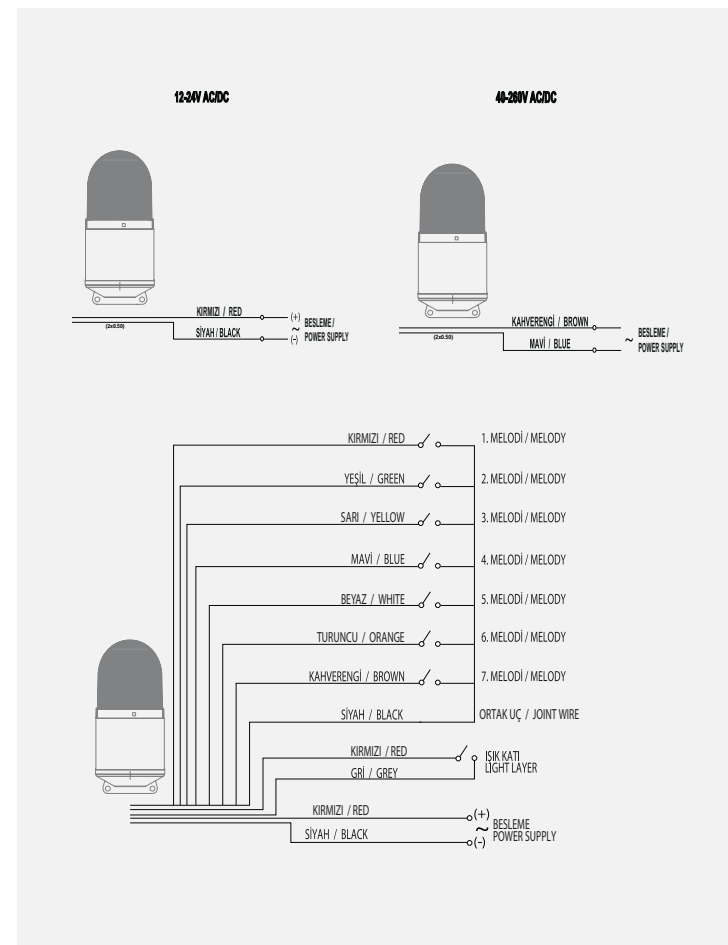

For more Details

Scan the QR Code for more information about the product

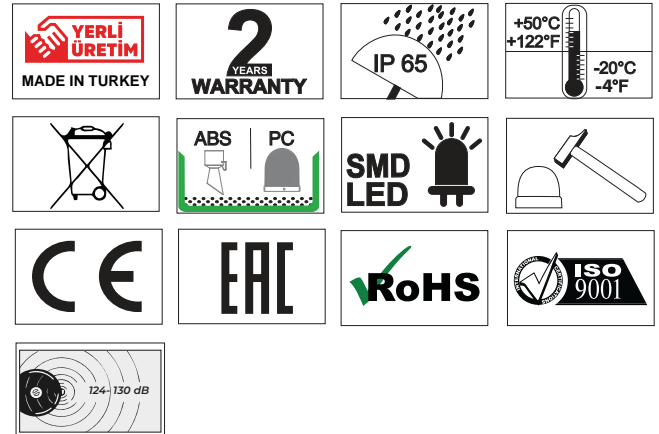



Stack Lights



RGB Warning Lights



Signal Beacons



LED Warning Horns



Beacon Horns



Electronic Sirens



Universal Beacon Horns

SNT-K71 Series Beacon Horns

Voltage Options:

SNT-K711-... : 12-24V AC/DC

SNT-K712-... : 40-260V AC/DC

Lens Diameter: 70mm

LED Module: SMD

Light Colors: Red, Green, Yellow, Blue, White

Light Modes: Steady, Flashing, Strobing

Sound: 16 melodies

Volume: 95-127dB

Mounting Types: Wall



SNT-K712- **1**

»»» Products Colors



SNT-K712- **2**



SNT-K712- **3**



SNT-K712 **4**



SNT-K712- **5**

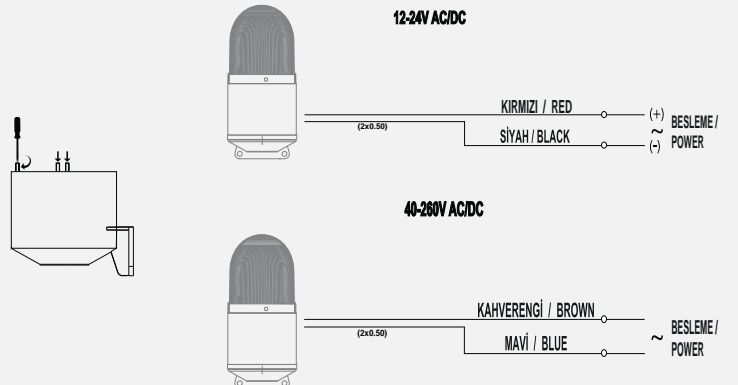
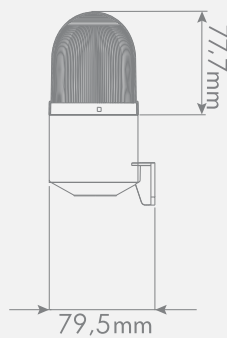
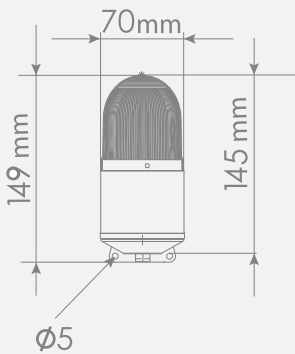

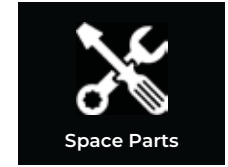

Mini Universal Beacon Horns

SNT-MK71 Series Beacon Horns

Voltage Options:

SNT-MK711-... : 12-24V AC/DC

SNT-MK712-... : 40-260V AC/DC

Lens Diameter: 70mm

LED Module: SMD

Light Colors: Red, Green, Yellow, Blue, White

Light Modes: Steady, Flashing, Strobing

Sound: 16 melodies

Volume: 95-127dB

Mounting Types: Wall



SNT-MK712-1

»»» Products Colors



SNT-MK712-2



SNT-MK712-KFS-3



SNT-MK712-4



SNT-MK712-5

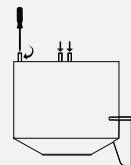
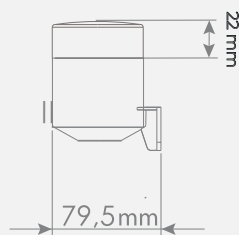
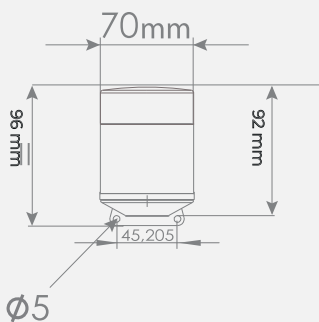

12-24V AC/DC



40-260V AC/DC



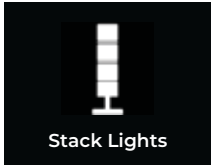

Stack Lights



RGB Warning Lights



Signal Beacons



LED Warning Horns



Beacon Horns



Electronic Sirens



Industrial Crane Horns

SNT-EK70 Series Led Horns

Lens Diameter: 70mm

LED Module: SMD

Light Colors: Red, Green, Yellow, Blue, White

Light Modes: Steady, Flashing, Strobing, Rotary

Sound: 7 melodies

Volume: 124-130dB

Mounting Types: Wall

7 Different melodies for 7 ignition inputs



Pressing 3 buttons at the same time gives a wrong use alarm sound!!!!

Voltage Options:

SNT-EK7013-... : 12-24V AC/DC

SNT-EK7022-... : 40-260V AC/DC



»»» Products Colors



SNT-EK7013-F1-2



SNT-EK7013-F1-3



SNT-EK7013-F1-4



SNT-EK7013-F1-5

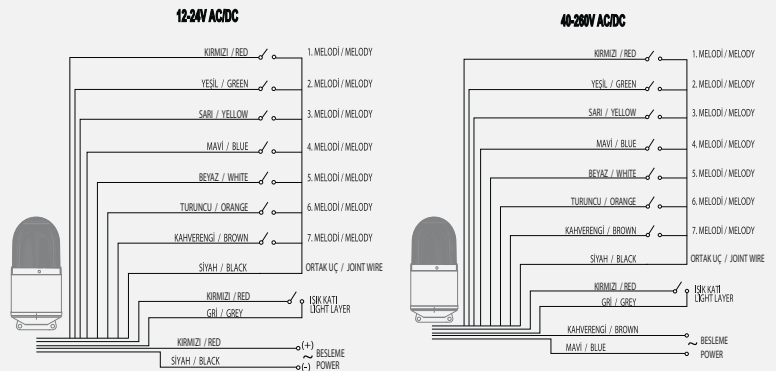
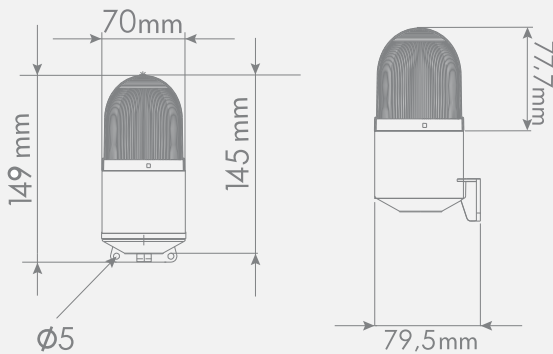



Obstruction Lights



Heavy Duty Lights



Safety Lights



Machine Tool Lights



Motor Sirens

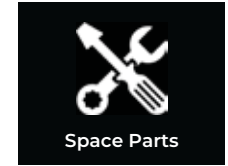

Space Parts



Beacon Horns

SNT-K710/K720 Series Beacon Horns

Voltage Options:

SNT-K710-... : 24V AC/DC

SNT-K720-... : 220V/AC

Lens Diameter: 70mm

LED Module: SMD

Light Colors: **Red**

Light Modes: Steady, Flashing

Sound: 2 melodies

Volume: 120-125dB

Mounting Types: Wall

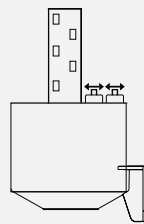
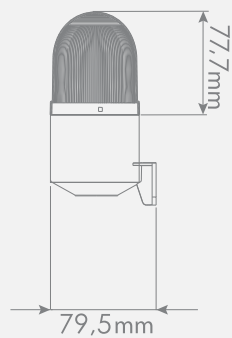
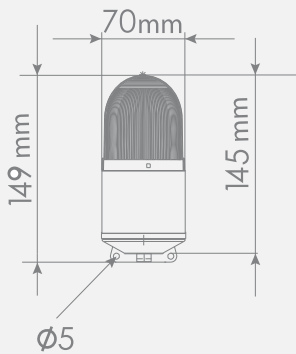

24V AC/DC

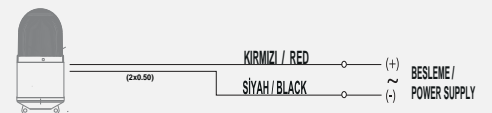

220V AC

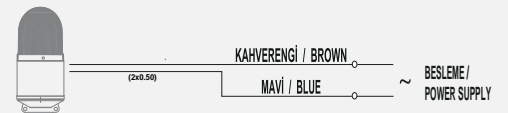



Stack Lights



RGB Warning Lights



Signal Beacons



LED Warning Horns



Beacon Horns



Electronic Sirens



Dry Contact Beacon Horns

SNT-K70 Series Led Horns with 1 Layer

Voltage Options:

SNT-K7013-... : 12-24V AC/DC

SNT-K7022-... : 40-260V AC/DC

Light Mode Options:

SNT-K70...-F1-... : Steady-Flashing

SNT-K70...-C1-... : Strobe

SNT-K70...-D1-... : Rotary

Lens Diameter: 70mm

LED Module: SMD

Light Colors: Red, Green, Yellow, Blue, White

Sound: 2 melodies

Volume: 120dB

Mounting Types: Wall



SNT-K7013-F1-1



Products Colors



SNT-K7013-F1-2



SNT-K7013-F1-3



SNT-K7013-F1-4



SNT-K7013-F1-5

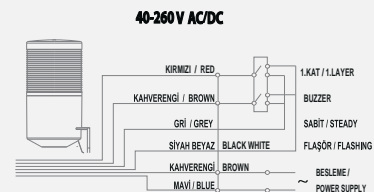
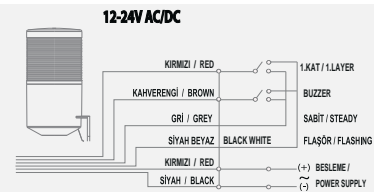
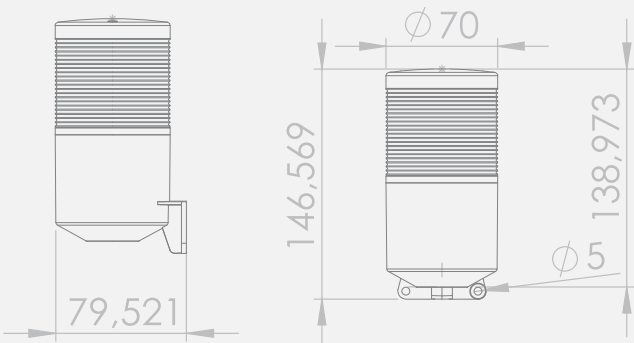



Obstruction Lights



Heavy Duty Lights



Safety Lights



Machine Tool Lights



Motor Sirens



Space Parts



Dry Contact Beacon Horns

SNT-K70 Series Led Horns with 2 Layer

Voltage Options:

SNT-K7013-... : 12-24V AC/DC
SNT-K7022-... : 40-260V AC/DC

Light Mode Options:

SNT-K70...-F2: Steady-Flashing
SNT-K70...-C2: Strobe
SNT-K70...-D2: Rotary

Lens Diameter: 70mm
LED Module: SMD
Light Colors: Red-Green
Sound: 2 melodies
Volume: 120dB
Mounting Types: Wall



Dry Contact Beacon Horns

SNT-K70 Series Led Horns with 3 Layer

Voltage Options:

SNT-K7013-... : 12-24V AC/DC
SNT-K7022-... : 40-260V AC/DC

Light Mode Options:

SNT-K70...-F3: Steady-Flashing
SNT-K70...-C3: Strobe
SNT-K70...-D3: Rotary

Lens Diameter: 70mm
LED Module: SMD
Light Colors: Red-Green-Yellow
Sound: 2 melodies
Volume: 120dB
Mounting Types: Wall

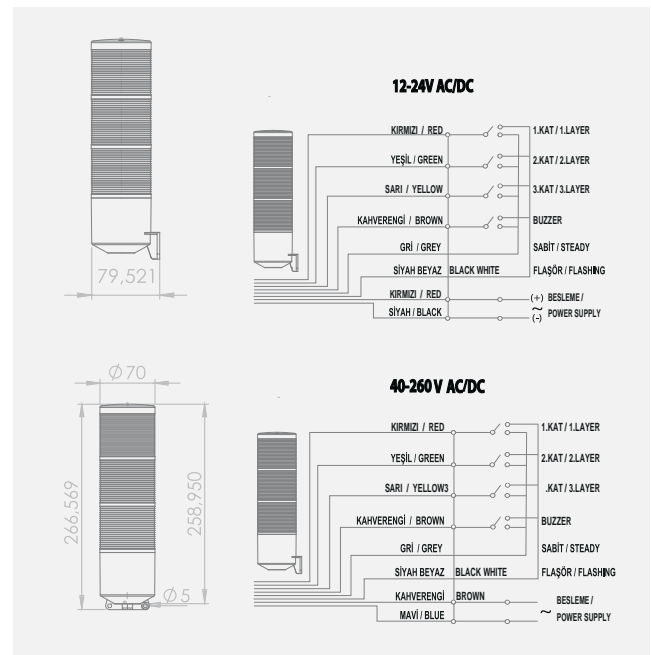
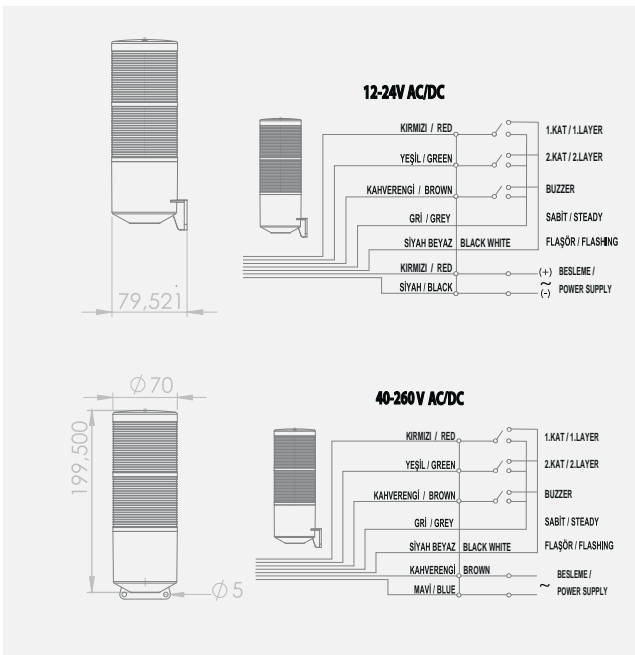



Stack Lights



RGB Warning Lights



Signal Beacons



LED Warning Horns

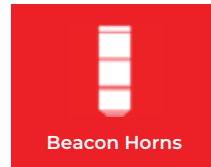

Beacon Horns



Electronic Sirens



Beacon Horns

PART NO	LENS DIA.	TYPE	POWER SUPPLY
SNT-K710-1	ø70	2Modes, SMD LED, Red	24V AC/DC
SNT-K720-1	ø70	2Modes, SMD LED, Red	220V/AC

1 !!!!! Series SNT-K710, SNT-K720 are sold as a set containing 25pcs and have only one color option, RED.



Universal Beacon Horns

PART NO	LENS DIA.	TYPE	POWER SUPPLY
SNT-K711-...	ø70	3Modes, SMD LED	12-24V AC/DC
SNT-K712-...	ø70	3Modes, SMD LED	40-260V AC/DC



Mini Universal Beacon Horns

PART NO	LENS DIA.	TYPE	POWER SUPPLY
SNT-MK711-...	ø70	3Modes, SMD LED	12-24V AC/DC
SNT-MK712-...	ø70	3Modes, SMD LED	40-260V AC/DC



Industrial Crane Horns

PART NO	LENS DIA.	TYPE	POWER SUPPLY
SNT-EK7013-S1-...	ø70	Steady, SMD LED	12-24V AC/DC
SNT-EK7022-S1-...	ø70	Steady, SMD LED	40-260V AC/DC
SNT-EK7013-F1-...	ø70	Flashing, SMD LED	12-24V AC/DC
SNT-EK7022-F1-...	ø70	Flashing, SMD LED	40-260V AC/DC
SNT-EK7013-C1-...	ø70	Strobe, SMD LED	12-24V AC/DC
SNT-EK7022-C1-...	ø70	Strobe, SMD LED	40-260V AC/DC
SNT-EK7013-D1-...	ø70	Rotary, SMD LED	12-24V AC/DC
SNT-EK7022-D1-...	ø70	Rotary, SMD LED	40-260V AC/DC

1 2 3 4 5

!!!! Please specify color codes in your orders.



Dry Contact Beacon Horns with 1 Layer

PART NO	LENS DIA.	TYPE	POWER SUPPLY
SNT-K7013-F1-...	ø70	Flashing-Steady, SMD LED	12-24V AC/DC
SNT-K7022-F1-...	ø70	Flashing-Steady, SMD LED	40-260V AC/DC
SNT-K7013-C1-...	ø70	Strobe, SMD LED	12-24V AC/DC
SNT-K7022-C1-...	ø70	Strobe, SMD LED	40-260V AC/DC
SNT-K7013-D1-...	ø70	Rotary, SMD LED	12-24V AC/DC
SNT-K7022-D1-...	ø70	Rotary, SMD LED	40-260V AC/DC

1 2 3 4 5 !!!!! Light codes must be indicated on one layer Dry Contact Beacon Horns.



Dry Contact Beacon Horns with 2 Layer

PART NO	LENS DIA.	TYPE	POWER SUPPLY
SNT-K7013-F2	ø70	Flashing-Steady, SMD LED	12-24V AC/DC
SNT-K7022-F2	ø70	Flashing-Steady, SMD LED	40-260V AC/DC
SNT-K7013-C2	ø70	Strobe, SMD LED	12-24V AC/DC
SNT-K7022-C2	ø70	Strobe, SMD LED	40-260V AC/DC
SNT-K7013-D2	ø70	Rotary, SMD LED	12-24V AC/DC
SNT-K7022-D2	ø70	Rotary, SMD LED	40-260V AC/DC

!!!!!! Standard Color Range; Red-Green For non stand color range contact company.



Dry Contact Beacon Horns with 3 Layer

PART NO	LENS DIA.	TYPE	POWER SUPPLY
SNT-K7013-F3	ø70	Flashing-Steady, SMD LED	12-24V AC/DC
SNT-K7022-F3	ø70	Flashing-Steady, SMD LED	40-260V AC/DC
SNT-K7013-C3	ø70	Strobe, SMD LED	12-24V AC/DC
SNT-K7022-C3	ø70	Strobe, SMD LED	40-260V AC/DC
SNT-K7013-D3	ø70	Rotary, SMD LED	12-24V AC/DC
SNT-K7022-D3	ø70	Rotary, SMD LED	40-260V AC/DC

!!!!!! Standard Color Range; Red-Green-Yellow For non stand color range contact company.



Stack Lights



RGB Warning Lights



Signal Beacons



LED Warning Horns



Beacon Horns



Electronic Sirens



Lens

PART NO	TYPE	CATEGORY	COLOR
SNT-M70-LNK	Ø70 Mini PC-Lens	Mini Series	Red
SNT-M70-LNY	Ø70 Mini PC-Lens	Mini Series	Green
SNT-M70-LNS	Ø70 Mini PC-Lens	Mini Series	Yellow
SNT-M70-LNM	Ø70 Mini PC-Lens	Mini Series	Blue
SNT-M70-LNB	Ø70 Mini PC-Lens	Mini Series	Transparent
SNT-YB70LNK	Ø70 PC-Lens	Beacon Horn	Red
SNT-YB70LNY	Ø70 PC-Lens	Beacon Horn	Green
SNT-YB70LNS	Ø70 PC-Lens	Beacon Horn	Yellow
SNT-YB70LNM	Ø70 PC-Lens	Beacon Horn	Blue
SNT-YB70LNB	Ø70 PC-Lens	Beacon Horn	Transparent
SNT-70LNK	Ø70 PC-Lens	Dry Contact Series	Red
SNT-70LNY	Ø70 PC-Lens	Dry Contact Series	Green
SNT-70LNS	Ø70 PC-Lens	Dry Contact Series	Yellow
SNT-70LNM	Ø70 PC-Lens	Dry Contact Series	Blue
SNT-70LNB	Ø70 PC-Lens	Dry Contact Series	Transparent
SNT-70KPK	Ø70 PC-Lens Cover	Dry Contact Series	Red
SNT-70KPY	Ø70 PC-Lens Cover	Dry Contact Series	Green
SNT-70KPS	Ø70 PC-Lens Cover	Dry Contact Series	Yellow
SNT-70KPM	Ø70 PC-Lens Cover	Dry Contact Series	Blue
SNT-70KPB	Ø70 PC-Lens Cover	Dry Contact Series	Transparent









Stack Lights



RGB Warning Lights



Signal Beacons



LED Warning Horns

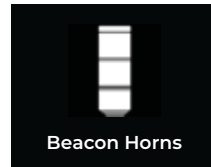

Beacon Horns



Electronic Sirens

ABS Cover

Potentiometer
Adjustment of Sound

Button Control
Melody Control

IP65 Protection Rate

ABS Housing





Obstruction Lights



Heavy Duty Lights



Safety Lights



Machine Tool Lights



Motor Sirens

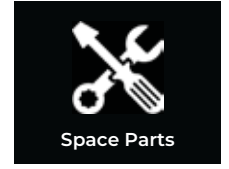

Space Parts

ELECTRONIC SIRENS

Electronic Sirens are perfect for giving audible signals in case of emergency or warning about imminent critical situations.

- Sound Options: 16/ 7/ 2/1 melodies
- Volume: **92-130dB**
- 7 Different melodies for 7 ignition inputs
- Housing: ABS
- Mounting Types: Surface & Wall
- Does not affected by water, dust, heat and UV rays
- Warranty: 2 Years

Voltage Options:

- Option 1: 12-24V AC/DC
- Option 2: 40-260V AC/DC
- Option 3: 24V /DC
- Option 4: 12V/DC
- Option 5: 220V/AC

For more Details

Scan the QR Code for more information about the product



- Before making electrical connections to the products, please read the user manuals included in the box!
- Do not energize signal and contact cables other than the power cable (2x0.50mm).
- The product is out of warranty when the signal and contact cables are energized.

The connection of the product should be made by at least electric technicians.

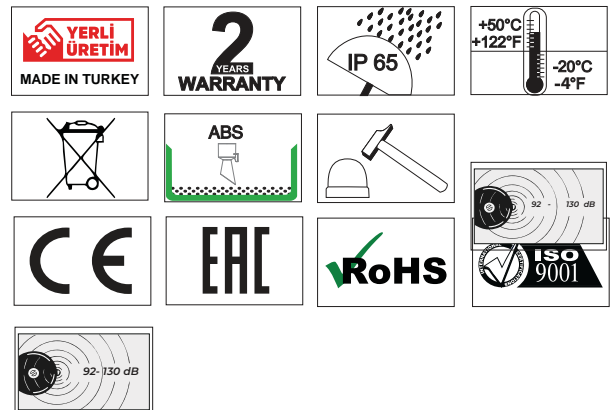
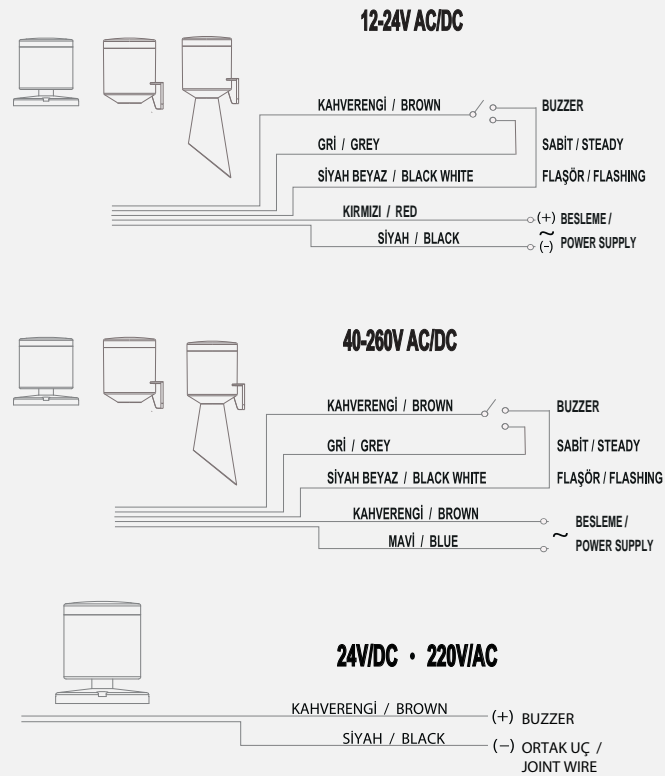

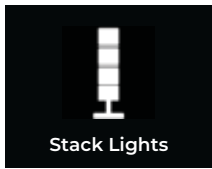

SNT-B712-F



SNT-K711-F



SNT-T7024-F



Electronic Sirens

Wall Mount Horn

Voltage Options:

- Option 1: 12-24V AC/DC
- Option 2: 40-260V AC/DC

Sound Options:

- SNT-B71... : 16 Melodies
- SNT-B70... : 2 Melodies
- SNT-EB70... : 7 Melodies

Diameter: 70mm
 Volume: 105-130dB
 Mounting Types: Wall
 SNT-EB70 Series: 7 different melodies for 7 ignition inputs

Electronic Sirens

Wall Mount Short Horn

Voltage Options:

- Option 1: 12-24V AC/DC
- Option 2: 40-260V AC/DC

Sound Options:

- SNT-K71... : 16 Melodies
- SNT-K70... : 2 Melodies
- SNT-EK70... : 7 Melodies

Diameter: 70mm
 Volume: 95-127dB
 Mounting Types: Wall
 SNT-EK70 Series: 7 different melodies for 7 ignition inputs

Electronic Sirens

Surface Mount Horn

Voltage Options:

- Option 1: 12-24V AC/DC
- Option 2: 40-260V AC/DC

Sound Options:

- Option 1: Steady-Flashing
- Option 2: Flashing

Diameter: 70mm
 Volume: 95-127dB
 Mounting Types: Surface & Wall

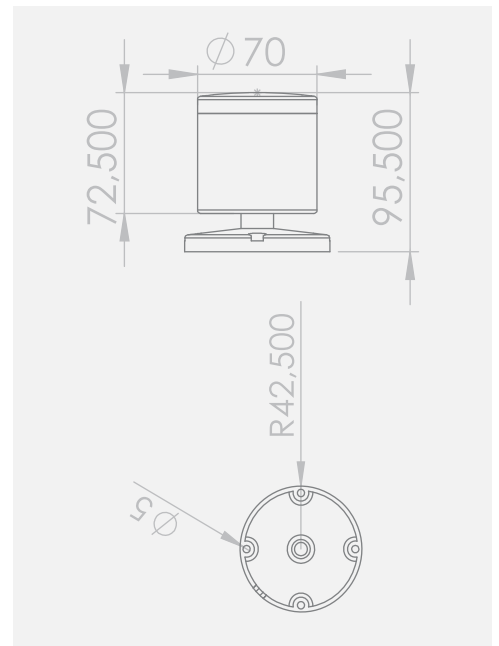
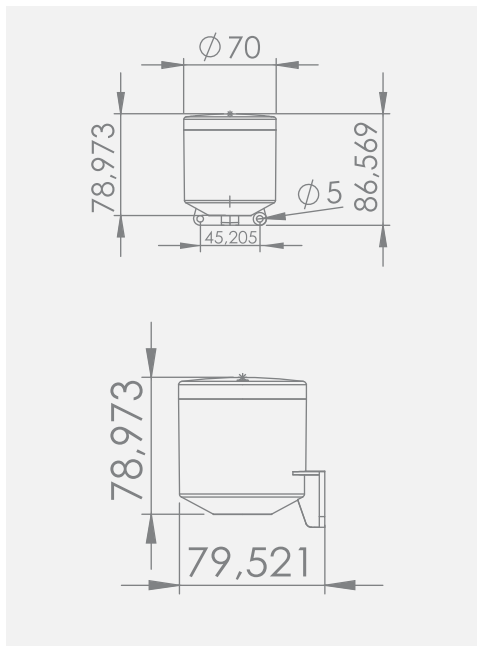
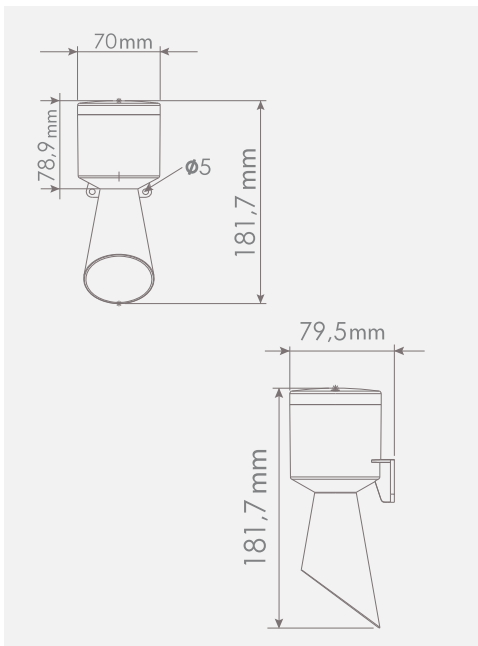



Obstruction Lights



Heavy Duty Lights



Safety Lights



Machine Tool Lights



Motor Sirens



Space Parts



SNT-40A12

Electronic Sirens

Square Buzzer

Voltage Options:
SNT-40A12: 12V/DC

Sound Options:
Option 1: Intermittent

Dimensions: 40x45mm
Volume: 127dB

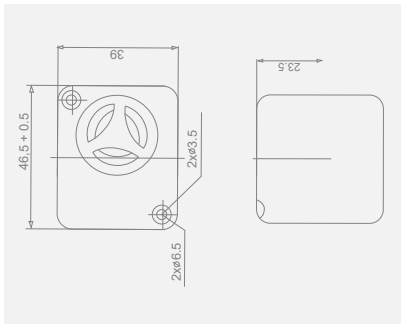

SNT-35A22

Electronic Sirens

M30 Buzzer

Voltage Options:
Option 3: 24V/DC
Option 5: 220V/AC

Sound Options:
35A: Continuous
35F: Intermittent

Diameter: 30mm
Volume: 105-110dB

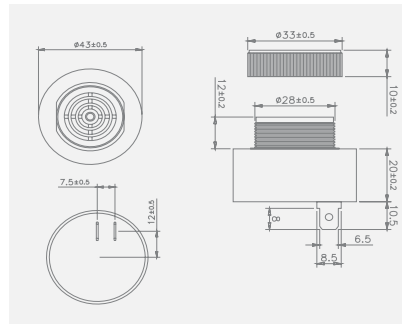

SNT-35L24

Electronic Sirens

M30 LED Buzzer

Voltage Options:
Option 3: 24V/DC
Option 5: 220V/AC

Sound Options:
35L: Intermittent

Light Options:
Option 1: Flashing

Diameter: 30mm
Volume: 105-110dB

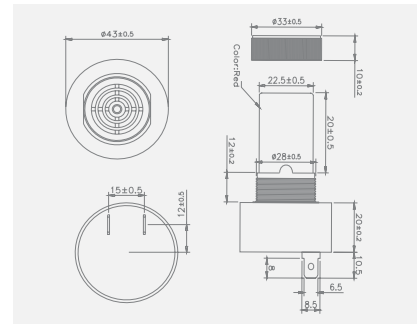

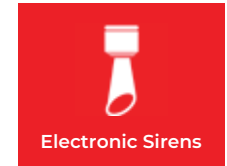
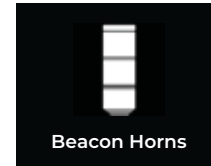

Wall Mount Horns

PART NO	LENS DIA.	TYPE	POWER SUPPLY
SNT-B711-F	ø70	16 Melodies, Wall Mount	12-24V AC/DC
SNT-B712-F	ø70	16 Melodies, Wall Mount	40-260V AC/DC
SNT-B7013-F	ø70	2 Melodies, Wall Mount	12-24V AC/DC
SNT-B7022-F	ø70	2 Melodies, Wall Mount	40-260V AC/DC
SNT-EB7013-F	ø70	7 Melodies, Wall Mount	12-24V AC/DC
SNT-EB7022-F	ø70	7 Melodies, Wall Mount	40-260V AC/DC



Wall Mount Short Horns

PART NO	LENS DIA.	TYPE	POWER SUPPLY
SNT-K711-F	ø70	16 Melodies, Wall Mount	12-24V AC/DC
SNT-K712-F	ø70	16 Melodies, Wall Mount	40-260V AC/DC
SNT-K7013-F	ø70	2 Melodies, Wall Mount	12-24V AC/DC
SNT-K7022-F	ø70	2 Melodies, Wall Mount	40-260V AC/DC
SNT-EK7013-F	ø70	7 Melodies, Wall Mount	12-24V AC/DC
SNT-EK7022-F	ø70	7 Melodies, Wall Mount	40-260V AC/DC



Surface Mount Horns

PART NO	LENS DIA.	TYPE	POWER SUPPLY
SNT-T7013-F	ø70	Continuous-Intermittent, Wall Mount	12-24V AC/DC
SNT-T7024-F	ø70	Intermittent, Wall Mount	24V/DC
SNT-T7022-F	ø70	Continuous-Intermittent, Wall Mount	40-260V AC/DC
SNT-T7012-F	ø70	Intermittent, Wall Mount	220V/AC



Electronic Sirens

PART NO	HOUSING DIA.	TYPE	POWER SUPPLY
SNT-35A22	Ø30	Continuous	220V/AC
SNT-35A24	Ø30	Continuous	24V/DC
SNT-35F22	Ø30	Intermittent	220V/AC
SNT-35F24	Ø30	Intermittent	24V/DC
SNT-35L22	Ø30	Intermittent , Red Light	220V/AC
SNT-35L24	Ø30	Intermittent, Red Light	24V/DC
SNT-40A12	40X45mm	Intermittent	12V/DC



Electronic Sirens - Spare Parts

PART NO	TYPE	COLOR
SNT-M70K	Ø70 ABS Mini Cover	Black
SNT-70K	Ø70 PC Cover	Black
SNT-10U	10cm Metal Extension Tube	Gray
SNT-20U	20cm Metal Extension Tube	Gray
SNT-30U	30cm Metal Extension Tube	Gray
SNT-70D	ABS Foldable Base	Black
SNT-70L	ABS Wall Bracket	Black
SNT-70LT	Ø70 Metal Wall Bracket	Black





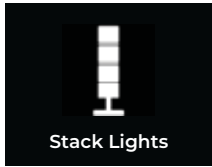

Stack Lights



RGB Warning Lights



Signal Beacons



LED Warning Horns



Beacon Horns



Electronic Sirens



- Mucco Low-intensity B type obstruction lights are manufactured according to ICAO (ANNEX 14) standards. All lighting systems have an IP65 protection class and are guaranteed for 2 years.
- By perceiving the level of light becomes active in the dark, becomes inactive in the daylight.
- It does not take account of the temporary loss of light throughout 30 sec. and it abolishes the light illusion.
- It gives a normally open, normally closed relay output over 30% in light loss and power failure.
- It has a 360-degree view range from 10 km.



OBSTRUCTION LIGHTS

Obstruction lights are vital in making high-rise buildings, towers and wind turbines visible to passing aircraft.

- Lens: Polycarbonate
- Lens Diameter: 100mm, 125mm
- LED Module: SMD
- LED life duration: 50.000 hrs
- Light Colors: Red, Green, Yellow
- Light Modes: Steady, Flashing
- Housing: ABS, Metal
- Mounting Types: Surface & Wall
- Does not affected by water, dust, heat and UV rays
- Warranty: 2 Years

- Compliant with Annex 14 ICAO standards.
- Activates in the dark and deactivated in the light by detecting the light level.
- It ignores the temporary light source for 30sec and eliminates the light illusion.
- Normally open, normally closed relay output in a condition of over %30 light loss and power cut.
- Visibility distance: 10km
- Visibility degree: 360
- Wireless option with solar energy.

Voltage Options:

- Option 1: 12V/DC
- Option 2: 24V/DC
- Option 3: 48V/DC
- Option 4: 85-260V/AC

For more Details

Scan the QR Code for more information about the product



- Before making electrical connections to the products, please read the user manuals included in the box!
- Do not energize signal and contact cables other than the power cable (2x0.50mm).
- The product is out of warranty when the signal and contact cables are energized.
- The connection of the product should be made by at least electric technicians.

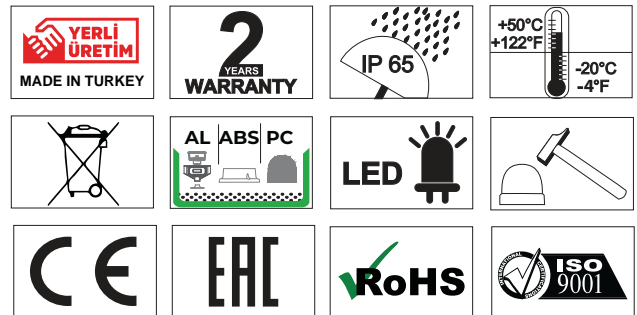
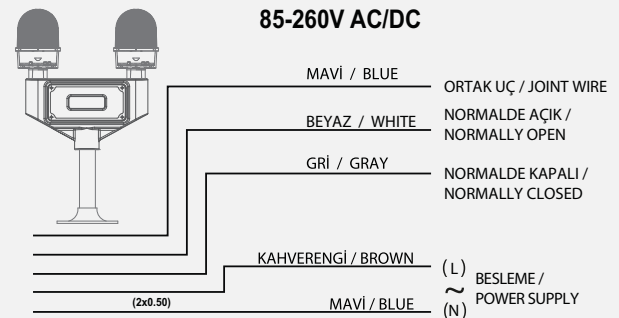
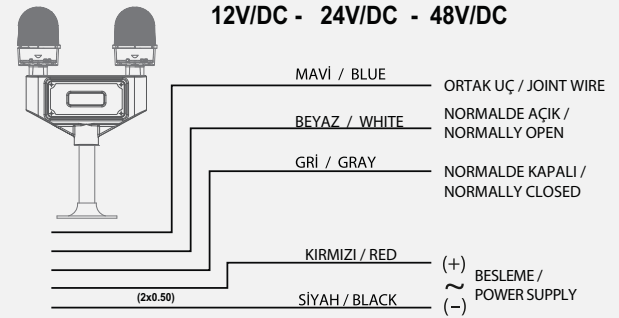

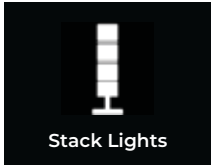

Stack Lights



RGB Warning Lights



Signal Beacons



LED Warning Horns



Beacon Horns



Electronic Sirens



100 Obstruction Light

Lens Diameter: 100mm
 Light Colors: Red
 Light Modes: Steady, Flashing
 Housing: ABS
 Mounting Types: Surface & Wall

Voltage Options:

- Option 1: 12V/DC
- Option 2: 24V/DC
- Option 3: 48V/DC
- Option 4: 85-260V/AC

Part no.	Light Mode
SNT-U100-...	Flashing
SNT-U100S-...	Steady

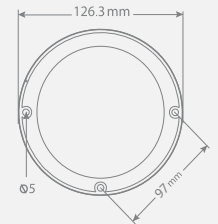
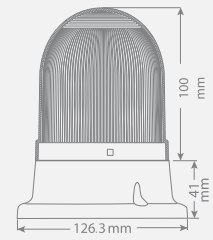

125 Obstruction Light

Lens Diameter: 125mm
 Light Colors: Red
 Light Modes: Steady, Flashing
 Housing: ABS
 Mounting Types: Surface & Wall

Voltage Options:

- Option 1: 12V/DC
- Option 2: 24V/DC
- Option 3: 48V/DC
- Option 4: 85-260V/AC

Part no.	Light Mode
SNT-U125-...	Flashing
SNT-U125S-...	Steady

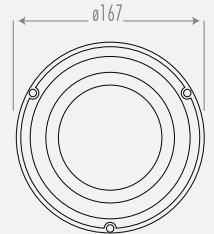
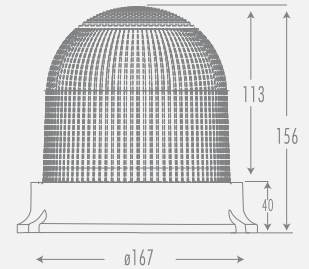

Base Mount Obstruction

Lens Diameter: 125mm
 Light Colors: Red
 Light Modes: Steady, Flashing
 Housing: Metal
 Mounting Types: Surface

Voltage Options:

- Option 1: 12V/DC
- Option 2: 24V/DC
- Option 3: 48V/DC
- Option 4: 85-260V/AC

Part no.	Light Mode
SNT-U125-DTI-...	Flashing
SNT-U125-SDTI-...	Steady

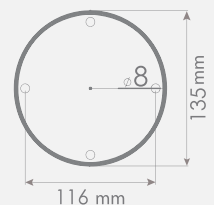
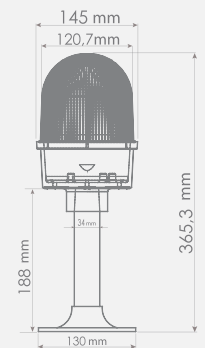



Obstruction Lights



Heavy Duty Lights



Safety Lights



Machine Tool Lights



Motor Sirens



Space Parts

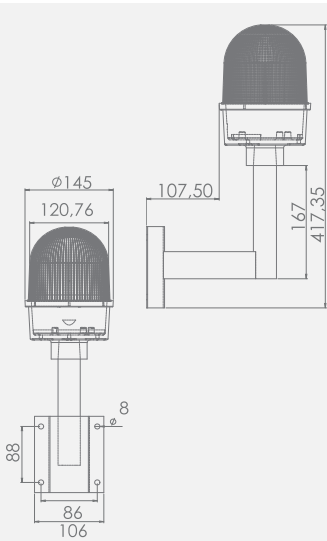

Single Arm Obstruction Light

Lens Diameter: 125mm
 Light Colors: Red
 Light Modes: Steady, Flashing
 Housing: Metal
 Mounting Types: Wall

Voltage Options:
 Option 1: 12V/DC
 Option 2: 24V/DC
 Option 3: 48V/DC
 Option 4: 85-260V/AC

Part no.	Light Mode
SNT-U125-D1-...	Flashing
SNT-U125-SD1-...	Steady

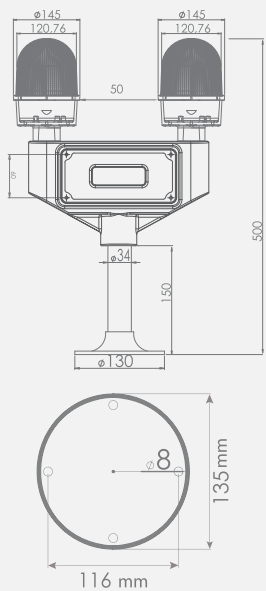

Dual Arm Obstruction Light

Lens Diameter: 125mm
 Light Colors: Red
 Light Modes: Steady, Flashing
 Housing: Metal
 Mounting Types: Surface

Voltage Options:
 Option 1: 12V/DC
 Option 2: 24V/DC
 Option 3: 48V/DC
 Option 4: 85-260V/AC

Part no.	Light Mode
SNT-U125-DT2-...	Flashing
SNT-U125-SDT2-...	Steady



A Single Lamp Operates in the Dual Obstruction Lights. At a %30 Light Loss or Damage, the Other Lamp Automatically Switches On

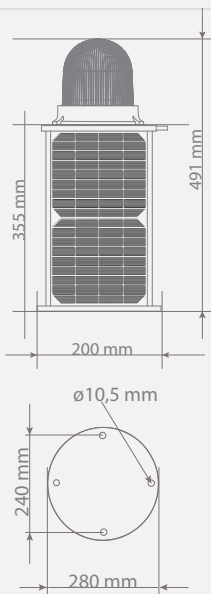

Base Mount Solar Obstruction Light

Lens Diameter: 125mm
 Light Colors: Red
 Light Modes: Steady, Flashing
 Housing: ABS/ Metal
 Mounting Types: Surface

Power Supply: Solar Energy
20W Solar Panel Obstruction Light.

Part no.	Light Mode
SNT-U125-SLT25	Flashing
SNT-U125-SSLT25	Steady



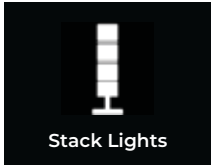

Stack Lights



RGB Warning Lights



Signal Beacons



LED Warning Horns



Beacon Horns



Electronic Sirens

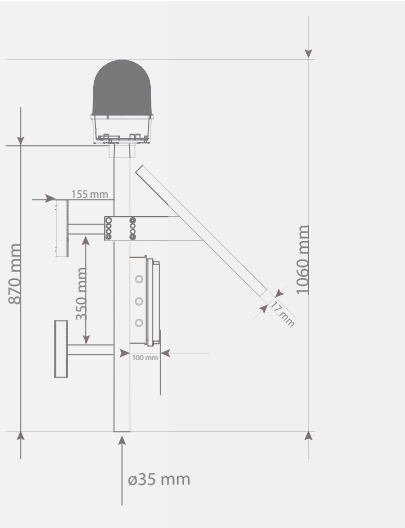
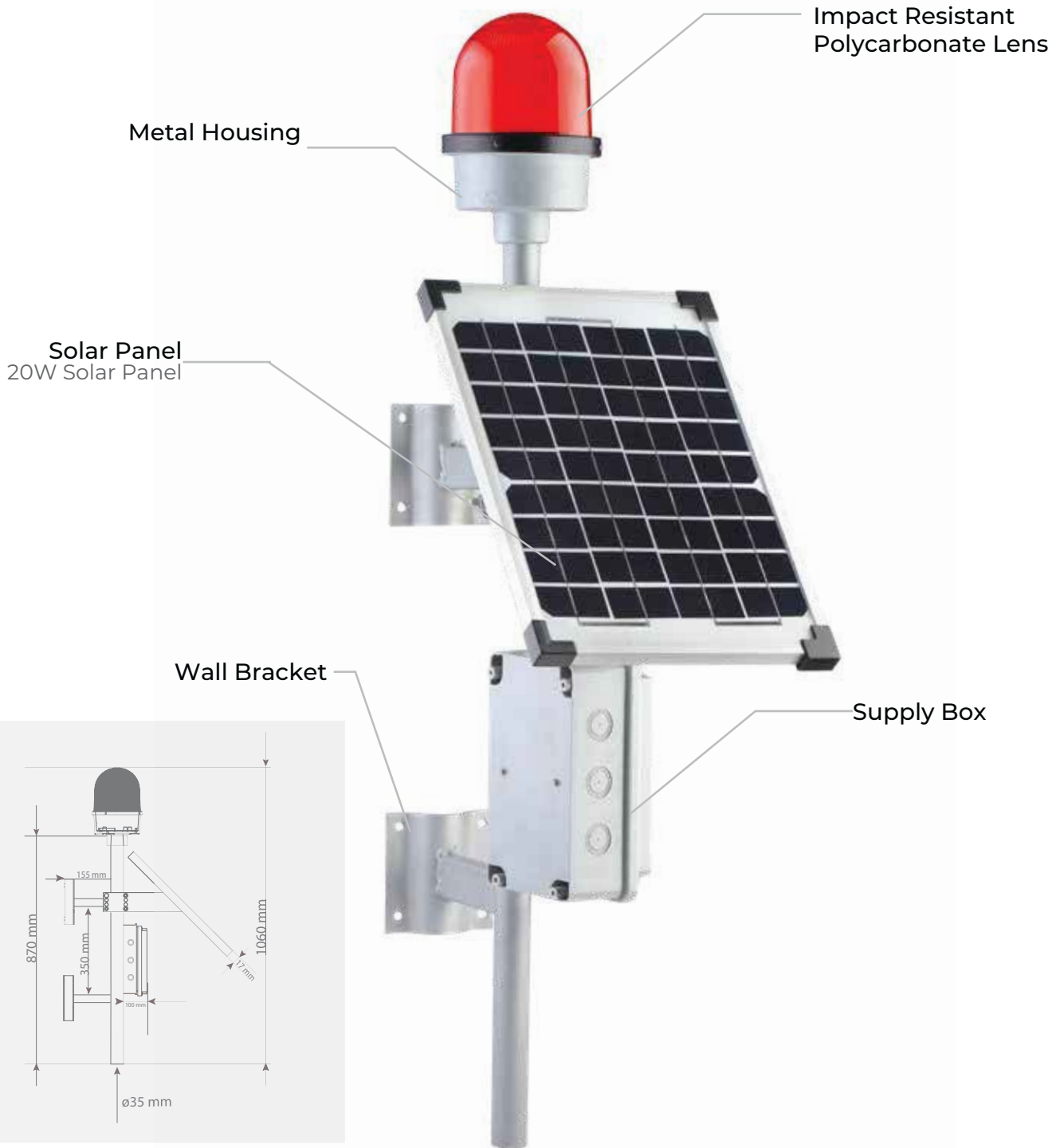

Wall Mount Solar Obstruction Light



- The product must be kept in a closed position when it is in the box or in unused areas. (Overdischarge of the battery causes the battery not to be recharged.)
- In order to for the product to be automatically activated, the switch located on top of the product must be in position "on". Product activates only when it gets dark.
- Ensure that the solar panel on the product has the best contact with the sun.

Lens Diameter: 125mm
 Light Colors: Red
 Light Modes: Steady, Flashing
 Housing: Metal
 Mounting Types: Wall

Part no.	Light Mode
SNT-U125-SL25	Flashing
SNT-U125-SSL25	Steady

20W Solar Panel Obstruction Light.





Stack Lights



RGB Warning Lights

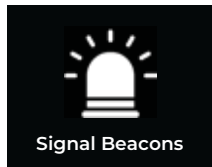

Signal Beacons



LED Warning Horns

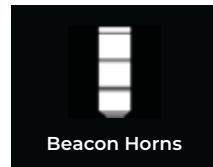

Beacon Horns



Electronic Sirens



100 Obstruction Light

PART NO	LENS DIA.	TYPE	POWER SUPPLY
SNT-U100-12	ø100	Flashing	12V/DC
SNT-U100-24	ø100	Flashing	24V/DC
SNT-U100-48	ø100	Flashing	48V/DC
SNT-U100-22	ø100	Flashing	85-260V/DC
SNT-U100S-12	ø100	Steady	12V/DC
SNT-U100S-24	ø100	Steady	24V/DC
SNT-U100S-48	ø100	Steady	48V/DC
SNT-U100S-22	ø100	Steady	85-260V/DC



125 Obstruction Light

PART NO	LENS DIA.	TYPE	POWER SUPPLY
SNT-U125-12	ø125	Flashing	12V/DC
SNT-U125-24	ø125	Flashing	24V/DC
SNT-U125-48	ø125	Flashing	48V/DC
SNT-U125-22	ø125	Flashing	85-260V/DC
SNT-U125S-12	ø125	Steady	12V/DC
SNT-U125S-24	ø125	Steady	24V/DC
SNT-U125S-48	ø125	Steady	48V/DC
SNT-U125S-22	ø125	Steady	85-260V/DC



Base Mount Obstruction Light

PART NO	LENS DIA.	TYPE	POWER SUPPLY
SNT-U125-DTI-12	ø125	Flashing	12V/DC
SNT-U125-DTI-24	ø125	Flashing	24V/DC
SNT-U125-DTI-48	ø125	Flashing	48V/DC
SNT-U125-DTI-22	ø125	Flashing	85-260V/DC
SNT-U125-SDTI-12	ø125	Steady	12V/DC
SNT-U125-SDTI-24	ø125	Steady	24V/DC
SNT-U125-SDTI-48	ø125	Steady	48V/DC
SNT-U125-SDTI-22	ø125	Steady	85-260V/DC

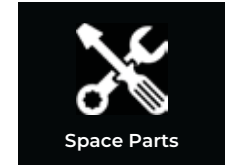

Single Arm Obstruction Light

PART NO	LENS DIA.	TYPE	POWER SUPPLY
SNT-U125-D1-12	ø125	Flashing	12V/DC
SNT-U125-D1-24	ø125	Flashing	24V/DC
SNT-U125-D1-48	ø125	Flashing	48V/DC
SNT-U125-D1-22	ø125	Flashing	85-260V/DC
SNT-U125-SD1-12	ø125	Steady	12V/DC
SNT-U125-SD1-24	ø125	Steady	24V/DC
SNT-U125-SD1-48	ø125	Steady	48V/DC
SNT-U125-SD1-22	ø125	Steady	85-260V/DC



Dual Arm Obstruction Light

PART NO	LENS DIA.	TYPE	POWER SUPPLY
SNT-U125-DT2-12	ø125	Flashing	12V/DC
SNT-U125-DT2-24	ø125	Flashing	24V/DC
SNT-U125-DT2-48	ø125	Flashing	48V/DC
SNT-U125-DT2-22	ø125	Flashing	85-260V/DC
SNT-U125-SDT2-12	ø125	Steady	12V/DC
SNT-U125-SDT2-24	ø125	Steady	24V/DC
SNT-U125-SDT2-48	ø125	Steady	48V/DC
SNT-U125-SDT2-22	ø125	Steady	85-260V/DC



Base Mount Solar Obstruction Light

PART NO	LENS DIA.	TYPE	POWER SUPPLY
SNT-U125-SLT25	ø125	Flashing	Solar Energy
SNT-U125-SSLT25	ø125	Steady	Solar Energy



Wall Mount Solar Obstruction Light

PART NO	LENS DIA.	TYPE	POWER SUPPLY
SNT-U125-SL25	ø125	Flashing	Solar Energy
SNT-U125-SSL25	ø125	Steady	Solar Energy



Mounting Parts

PART NO	TYPE	CATEGORY	COLOR
SNT-125LNK	ø125 PC-Lens	Obstruction Light	Red
SNT-125L	Metal Wall Bracket	Obstruction Light	Gray
SNT-125TB	Metal Surface Bracket	Obstruction Light	Gray







Stack Lights



RGB Warning Lights



Signal Beacons



LED Warning Horns

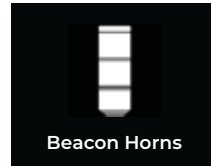

Beacon Horns



Electronic Sirens

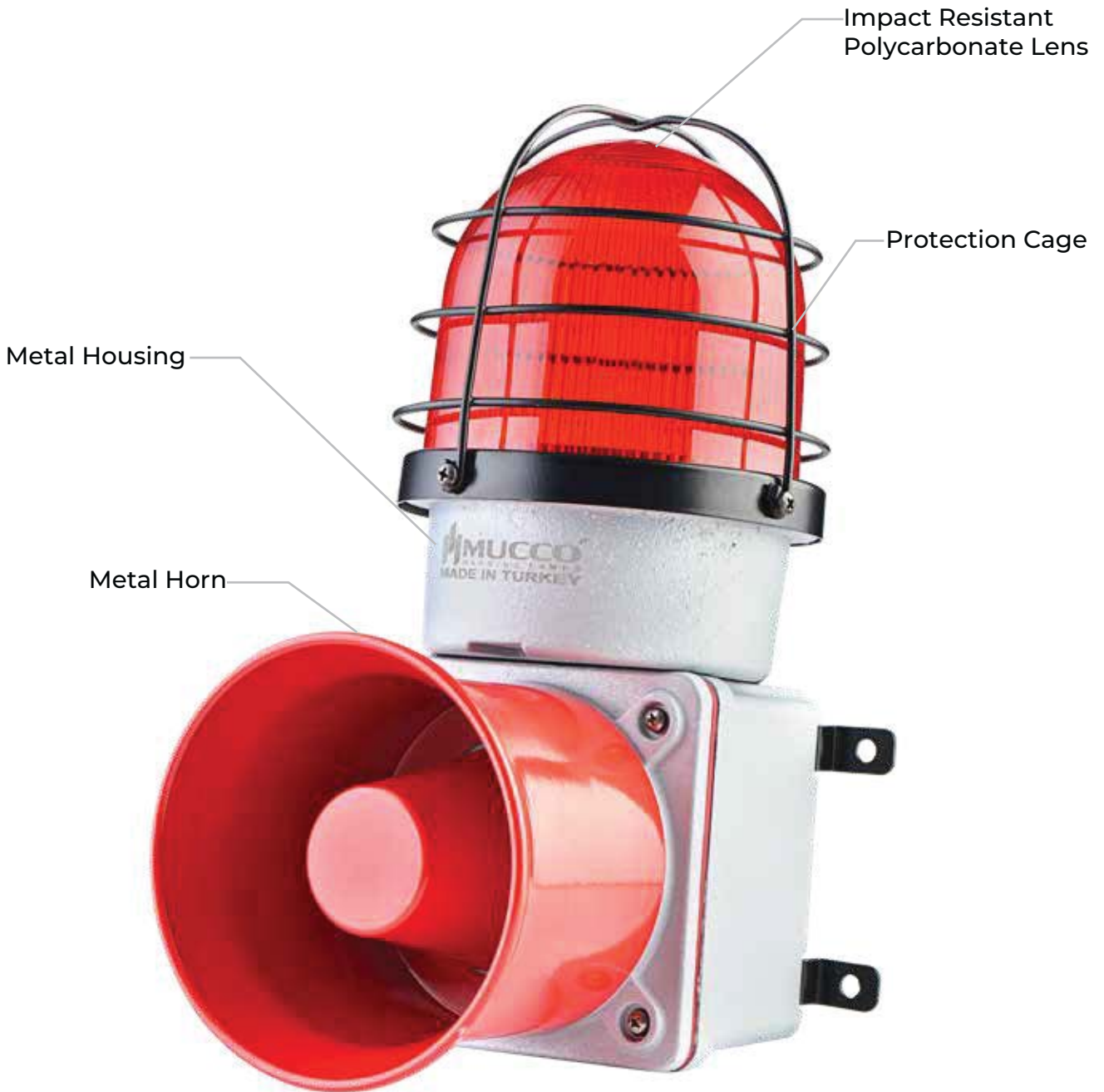

- They are combinations of Industrial Illuminated Sirens, Warning Lamps, and Electronic Sirens. They are generally used in the most difficult conditions in industrial areas. It is resistant to harsh weather conditions.
- They are combinations of Industrial Illuminated Sirens, Warning Lamps, and Electronic Sirens. They are generally used in the most difficult conditions in industrial areas. It is resistant to harsh weather conditions.
- When You energize the buzzer wires, the product is out of warranty.
- When 3 buttons are pressed at the same time, wrong use alarm sound starts beeping.
- Heavy-Duty Warning Lights are produced in Strobe light mode. For other light options contact the company.





Obstruction Lights



Heavy Duty Lights



Safety Lights



Machine Tool Lights



Motor Sirens

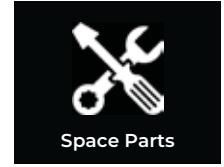

Space Parts

HEAVY DUTY WARNING LIGHTS

They are combinations of Industrial Illuminated Sirens, Warning Lamps, and Electronic Sirens. They are generally used in the most difficult conditions in industrial areas. It is resistant to harsh weather conditions.

- Lens: Polycarbonate
- Lens Diameter: 125mm
- LED Module: 3W POWER
- LED life duration: 50.000 hrs
- Light Colors: Red, Green, Yellow, Blue, White
- Light Modes: Steady, Flashing, Strobing, Rotary
- Sound: 7 melodies
- Volume: 90-133dB
- Sound and Light can be controlled separately
- Housing: ABS / Metal
- Mounting Types: Surface & Wall
- Protection Cage against strokes
- Does not affected by water, dust, heat and UV rays
- Warranty: 2 Years

Voltage Options:

- Option 1: 12-24V AC/DC
- Option 2: 12-30V AC/DC
- Option 3: 48V/DC
- Option 4: 85-260V AC/DC



- Before making electrical connections to the products, please read the user manuals included in the box!
- Do not energize signal and contact cables other than the power cable (2x0.50mm).
- The product is out of warranty when the signal and contact cables are energized.

The connection of the product should be made by at least electric technicians.

12-30V/DC - 48V/DC

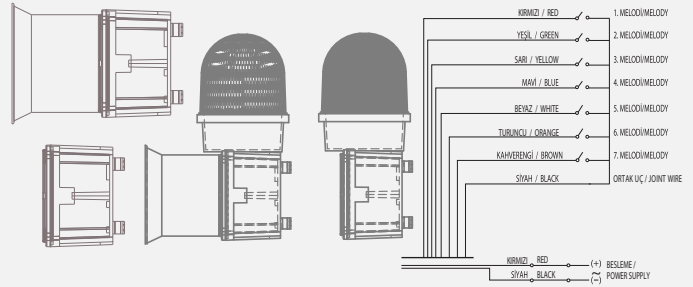

85-260V AC/DC

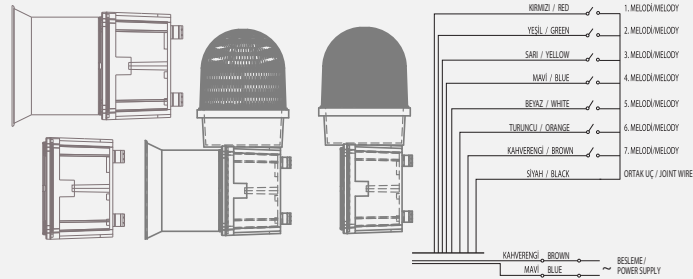

For more Details

Scan the QR Code for more information about the product

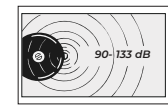
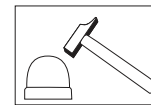
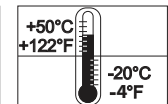



Stack Lights



RGB Warning Lights



Signal Beacons



LED Warning Horns



Beacon Horns



Electronic Sirens



SNT-DU12513-1

SNT-D12513-1

Heavy Duty Warning Lights

DU125 & D125 series heavy duty warning lights

Voltage Options:

SNT-DU12513-... / SNT-D12513-... : 12-24V AC/DC
SNT-DU12522-... / SNT-D12522-... : 85-260V AC/DC

- LED Module: 3W POWER
- Light Colors: Red, Green, Yellow, Blue, White
- Light Modes: Strobing
- Sound: 10 melodies
- Volume: 90-126dB
- Sound and Light can be controlled separately
- Housing: Metal
- Mounting Types: Surface & Wall
- Protection Cage against strokes

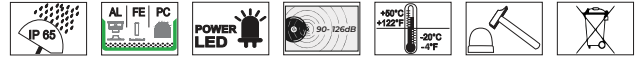

Products Colors



SNT-DU12513-2



SNT-DU12513-KFS-3



SNT-DU12513-4



SNT-DU12513-KFS-5



SNT-D12513-2



SNT-D12513-3



SNT-D12513-KFS-4



SNT-D12513-5

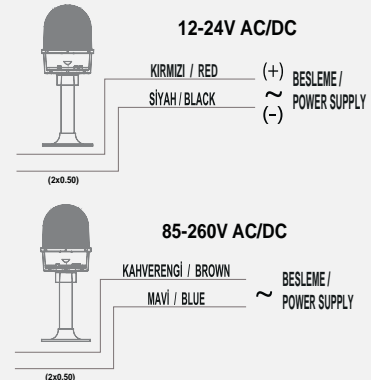
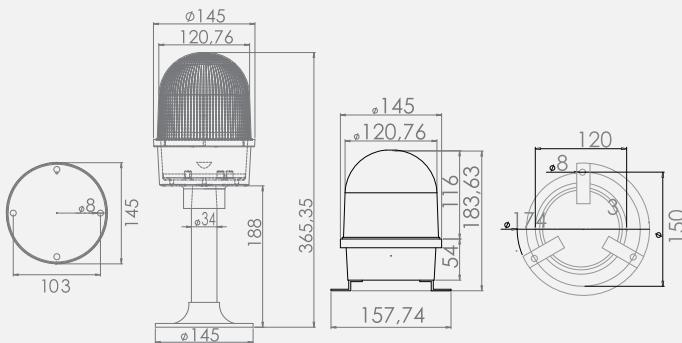



Obstruction Lights



Heavy Duty Lights



Safety Lights



Machine Tool Lights



Motor Sirens



Space Parts



SNT-E12513-D-1

Heavy Duty Beacon Sirens

E125 & EB120 series heavy duty sirens

Voltage Options:

- SNT-E12513-D-... / SNT-EB120-13 : 12-30V/DC
- SNT-E12548-D-... / SNT-EB120-48: 48V/DC
- SNT-E12522-D-... / SNT-EB120-22: 220V AC/DC

- LED Module: 3W POWER
- Light Colors: Red, Green, Yellow, Blue, White
- Light Modes: Strobing
- Sound: 7 melodies
- Volume: 125-133dB
- Sound and Light can be controlled separately
- Housing: Metal
- Mounting Types: Surface & Wall
- Protection Cage against strokes



»»» Products Colors



SNT-E12513-D-2



SNT-E12513-D-3



SNT-E12513-D-4



SNT-E12513-D-5

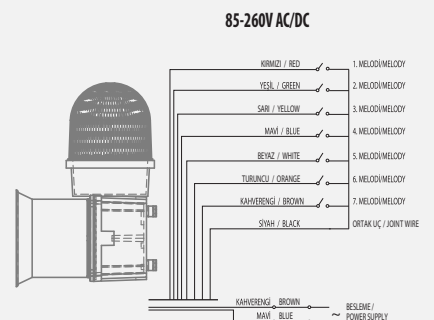
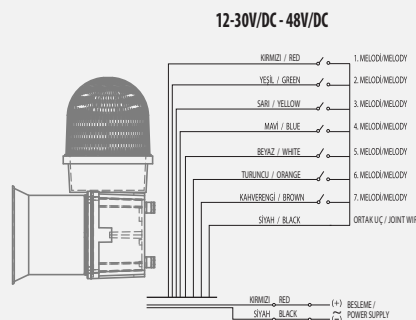
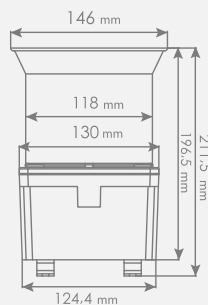
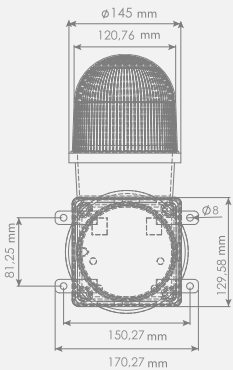

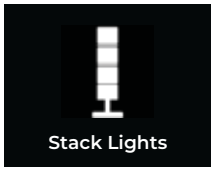

Stack Lights



RGB Warning Lights



Signal Beacons



LED Warning Horns



Beacon Horns



Electronic Sirens



SNT-ES12513-D-1

Heavy Duty Beacon Sirens

ES125 & ES120 series heavy duty sirens

Voltage Options:

SNT-ES12513-D-... / SNT-ES120-13 : 12-30V/DC
 SNT-ES12548-D-... / SNT-ES120-48: 48V/DC
 SNT-ES12522-D-... / SNT-ES120-22: 220V AC/DC

- LED Module: 3W POWER
- Light Colors: Red, Green, Yellow, Blue, White
- Light Modes: Strobing
- Sound: 7 melodies
- Volume: 125-133dB
- Sound and Light can be controlled separately
- Housing: Metal
- Mounting Types: Surface & Wall
- Protection Cage against strokes



Products Colors



SNT-ES12513-D-2



SNT-ES12513-D-3



SNT-ES12513-D-4



SNT-ES12513-D-5

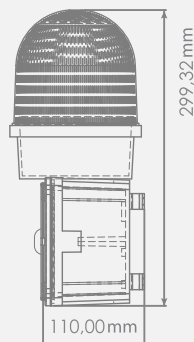
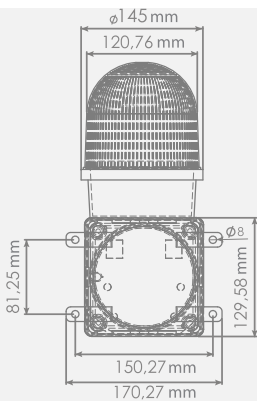

12-30V/DC - 48V/DC

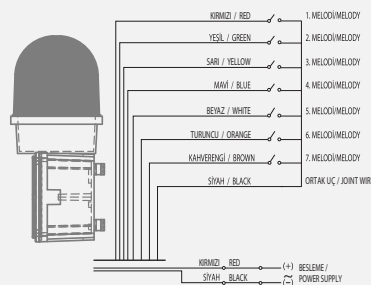

85-260V AC/DC

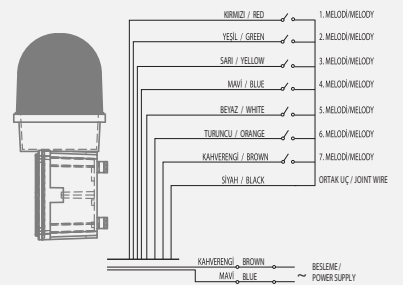



Obstruction Lights



Heavy Duty Lights



Safety Lights



Machine Tool Lights



Motor Sirens



Space Parts



SNT-ESP13-1

Heavy Duty Beacon Sirens

ESP series heavy duty sirens

- LED Module: SMD LED
- Light Colors: Red, Green, Yellow, Blue, White
- Light Modes: Steady, Flashing & Strobing
- Sound: 7 melodies
- Volume: 125-133dB
- Sound and Light can be controlled separately
- Housing: Metal
- Mounting Types: Surface & Wall
- Protection Cage against strokes

Voltage Options:

SNT-ESP24-... : 12-30V/DC

SNT-ESP48-... : 48V/DC

SNT-ESP22-... : 220V AC/DC

NEW PRODUCT!

● Utility Model Patent No: 2020/02240

Products Colors



SNT-ESP13-2



SNT-ESP13-3



SNT-ESP13-4



SNT-ESP13-5

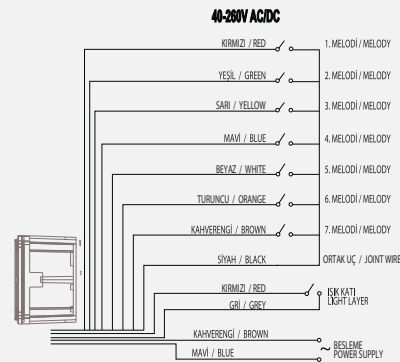
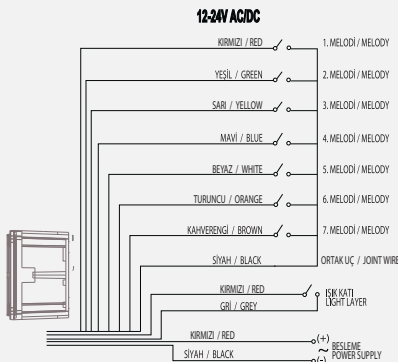



Stack Lights



RGB Warning Lights



Signal Beacons



LED Warning Horns

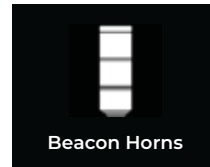

Beacon Horns



Electronic Sirens



DU-125 Series Heavy Duty Warning Lights

PART NO	LENS DIA.	TYPE	POWER SUPPLY
SNT-DU12513-...	ø125	Strobe	12-24V AC/DC
SNT-DU12522-...	ø125	Strobe	85-260V AC/DC
SNT-DU12513-B-...	ø125	Strobe, Buzzer	12-24V AC/DC
SNT-DU12522-B-...	ø125	Strobe, Buzzer	85-260V AC/DC
SNT-DU12513-KFS-...	ø125	Strobe, Prot.Cage	12-24V AC/DC
SNT-DU12522-KFS-...	ø125	Strobe, Prot.Cage	85-260V AC/DC
SNT-DU12513-B-KFS-...	ø125	Strobe, Buzzer, Prot.Cage	12-24V AC/DC
SNT-DU12522-B-KFS-...	ø125	Strobe, Buzzer, Prot.Cage	85-260V AC/DC

!!!! Standard light mode production: Strobe. For Steady-Flashing-Rotary Light modes contact the company



D125 Series Heavy Duty Warning Lights

PART NO	LENS DIA.	TYPE	POWER SUPPLY
SNT-D12513-...	ø125	Strobe	12-24V AC/DC
SNT-D12522-...	ø125	Strobe	85-260V AC/DC
SNT-D12513-B-...	ø125	Strobe, Buzzer	12-24V AC/DC
SNT-D12522-B-...	ø125	Strobe, Buzzer	85-260V AC/DC
SNT-D12513-KFS-...	ø125	Strobe, Prot.Cage	12-24V AC/DC
SNT-D12522-KFS-...	ø125	Strobe, Prot.Cage	85-260V AC/DC
SNT-D12513-B-KFS-...	ø125	Strobe, Buzzer, Prot.Cage	12-24V AC/DC
SNT-D12522-B-KFS-...	ø125	Strobe, Buzzer, Prot.Cage	85-260V AC/DC

!!!! Standard light mode production: Strobe. For Steady-Flashing-Rotary Light modes contact the company



EB120 Series Heavy Duty Warning Sirens

PART NO	LENS DIA.	TYPE	POWER SUPPLY
SNT-EB120-13	-	7 Melodies	12-30V/DC
SNT-EB120-48	-	7 Melodies	48V AC/DC
SNT-EB120-22	-	7 Melodies	85-260V AC/DC

1 2 3 4 5

!!!! Please specify color codes in your orders.



E125 Series Heavy Duty Beacon Sirens

PART NO	LENS DIA.	TYPE	POWER SUPPLY
SNT-E12513-D-...	ø125	Strobe, 7 Melodies, Prot.Cage	12-30V/DC
SNT-E12548-D-...	ø125	Strobe, 7 Melodies, Prot.Cage	48V AC/DC
SNT-E12522-D-...	ø125	Strobe, 7 Melodies, Prot.Cage	85-260V AC/DC

!!!! Standard light mode production: Strobe. For Steady-Flashing-Rotary Light modes contact the company



ES120 Series Heavy Duty Warning Sirens

PART NO	LENS DIA.	TYPE	POWER SUPPLY
SNT-ES120-13	-	7 Melodies	12-30V/DC
SNT-ES120-48	-	7 Melodies	48V AC/DC
SNT-ES120-22	-	7 Melodies	85-260V AC/DC



ES125 Series Heavy Duty Beacon Sirens

PART NO	LENS DIA.	TYPE	POWER SUPPLY
SNT-ES12513-D-...	ø125	Strobe, 7 Melodies, Prot.Cage	12-30V/DC
SNT-ES12548-D-...	ø125	Strobe, 7 Melodies, Prot.Cage	48V AC/DC
SNT-ES12522-D-...	ø125	Strobe, 7 Melodies, Prot.Cage	85-260V AC/DC

!!!! Standard light mode production: Strobe. For Steady-Flashing-Rotary Light modes contact the company



ESP Series Heavy Duty Beacon Sirens

PART NO	LENS DIA.	TYPE	POWER SUPPLY
SNT-ESP24-...	...X...	3Modes, 7 Melodies	12-30V/DC
SNT-ESP48-...	...X...	3Modes, 7 Melodies	48V AC/DC
SNT-ESP22-...	...X...	3Modes, 7 Melodies	85-260V AC/DC



Mounting Parts

PART NO	TYPE	CATEGORY	COLOR
SNT-125LNK	Ø125 PC-Lens	Heavy-Duty Sirens	Red
SNT-125KFS	Ø125 Metal Protection Cage	Heavy-Duty Sirens	Black
SNT-125TB	Metal Surface Bracket	Heavy-Duty Sirens	Gray

1 2 3 4 5

!!!! Please specify color codes in your orders.











Stack Lights



RGB Warning Lights



Signal Beacons



LED Warning Horns

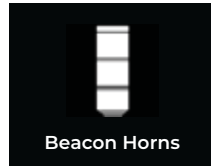

Beacon Horns



Electronic Sirens



- The use of safety lights makes it easier and safer for crane and forklift operators to work. Safety lights provide greater control over the load. It is the best solution to increase employees' safety in loading areas of cranes and forklifts, especially for crowded workplaces.
- Safety lights are mounted on cranes and forklifts to draw attention to the movement of cranes and forklifts and the load they carry.

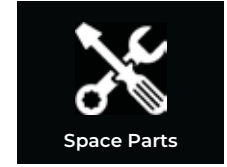

CRANE & FORKLIFT SAFETY LIGHTS

The use of safety lights makes it easier and safer for crane and forklift operators to work. Safety lights provide greater control over the load. It is the best solution to increase employees' safety in loading areas of cranes and forklifts, especially for crowded workplaces.

- Lens: Polycarbonate Glass, Tempered Glass
- LED Module: Power LED
- LED life duration: 50.000 hrs
- Light Colors: Red, Blue, White
- Light Modes: Steady, Steady Point Light, Steady Line Light
- Housing: Metal
- Mounting Types: Machinery, Forklift, Crane Mount
- Does not affected by water, dust, heat and UV rays
- Warranty: 2 Years

Voltage Options:

- Option 1: 24V AC/DC
- Option 2: 10-30V/DC
- Option 3: 10-48V/DC
- Option 4: 10-60V/DC
- Option 5: 10-80V/DC

For more Details

Scan the QR Code for more information about the product



- Before making electrical connections to the products, please read the user manuals included in the box!
- The connection of the product should be made by at least electric technicians.

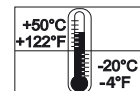
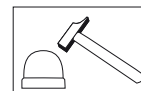
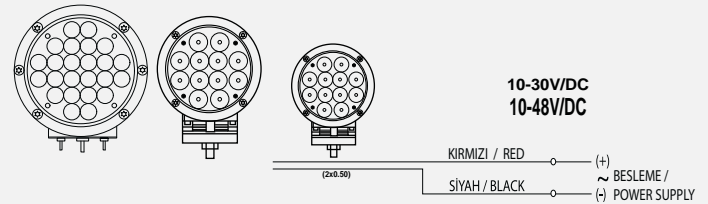
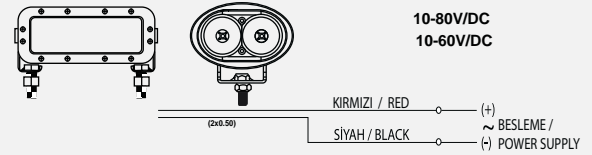



Stack Lights



RGB Warning Lights



Signal Beacons



LED Warning Horns

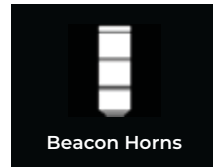



Beacon Horns



Electronic Sirens



10W Forklift Safety Light BL182 Series Forklift safety light

Light Colors: Red, Blue
Light Shape: Point  
Housing: Metal
Protection Rate: IP67

Part no.	Power Supply	Color
SNT-BL182-1	10-60V/DC	Red
SNT-BL182-4	10-48V/DC	Blue

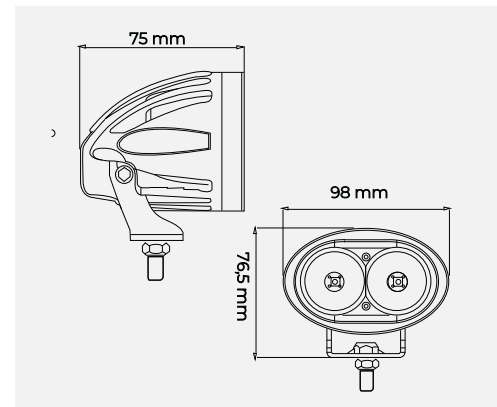



10W Forklift Safety Light RL183 Series Forklift safety light

Light Colors: Red
Light Shape: Line 
Housing: Metal
Protection Rate: IP67

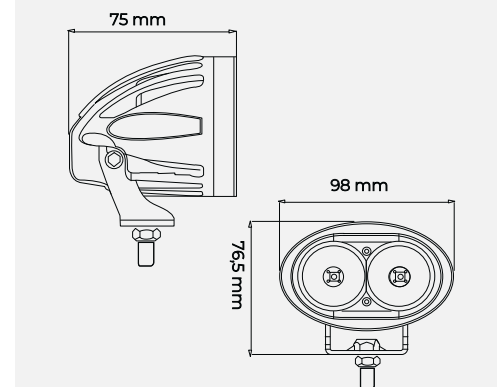
Part no.	Power Supply	Color
SNT-RL183-1	10-48V/DC	Red





18W Forklift Safety Light RL181-Series Forklift safety light

Light Colors: Red
Light Shape: Line  
Housing: Metal
Protection Rate: IP67

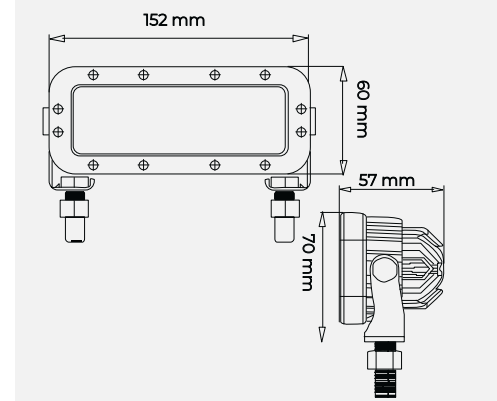
Part no.	Power Supply	Color
SNT-RL181-1	10-80V/DC	Red
SNTRL181-4	10-80V/DC	Blue



27W Forklift Safety Light UL181-Series Forklift safety light

Light Colors: Red
Light Shape: U-Shape  
Housing: Metal
Protection Rate: IP67

Part no.	Power Supply	Color
SNT-UL181-1	10-80V/DC	Red
SNT-UL181-4	10-80V/DC	Blue

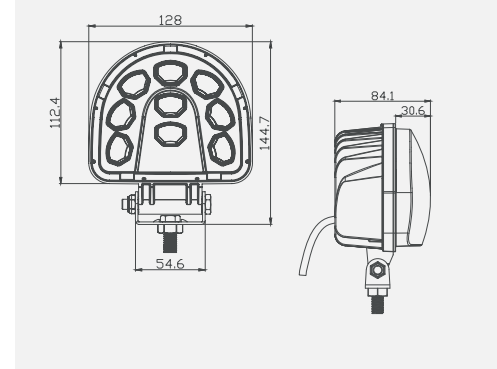

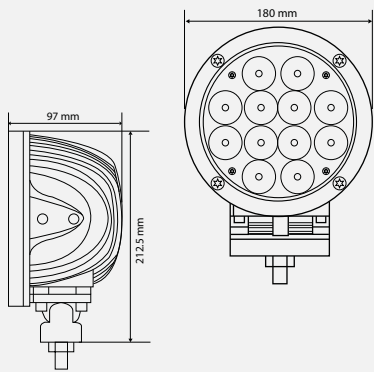

45W Crane Safety Light BL184 Series Forklift safety light

Light Colors: Red, Blue
Light Shape: Point ●●
Housing: Metal
Protection Rate: IP68

Part no.	Power Supply	Color
SNT-BL184-1	10-48V/DC	Red
SNT-BL184-4	10-48V/DC	Blue

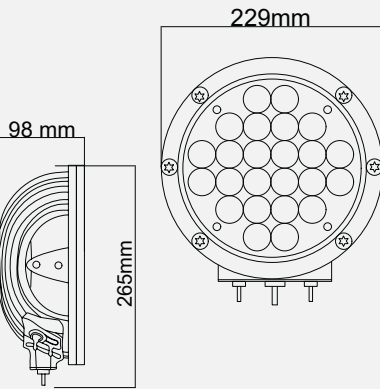

60W Crane Safety Light BL186 Series Forklift safety light

Light Colors: Red, Blue
Light Shape: Point ●●
Housing: Metal
Protection Rate: IP68

Part no.	Power Supply	Color
SNT-BL186-1	10-30V/DC	Red
SNT-BL186-4	10-30V/DC	Blue

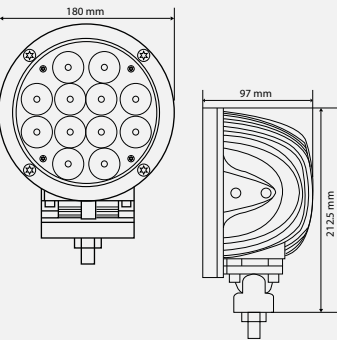

120W Crane Safety Light BL188 Series Forklift safety light

Light Colors: Red, Blue
Light Shape: Point ●●
Housing: Metal
Protection Rate: IP68

Part no.	Power Supply	Color
SNT-BL188-1	10-30V/DC	Red
SNT-BL188-4	10-30V/DC	Blue



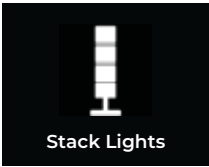

Stack Lights



RGB Warning Lights



Signal Beacons



LED Warning Horns



Beacon Horns



Electronic Sirens

Tempered Glass

Aluminum Housing

Waterproof Switch

Aluminum Tube

Durable Joints
Positioning lamp as you like

Strong Lamp Base



For more Details

Scan the QR Code for more information about the product

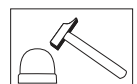
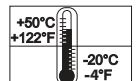



Obstruction Lights



Heavy Duty Lights



Safety Lights



Machine Tool Lights



Motor Sirens



Space Parts

Machine Tool Lights

Machine interior lighting, the places which need local accent lighting such as carved machine, sparks machine, CNC machine, workbench lighting , laser machinery, ceramic machinery and equipment, medical equipment, automated.....

- Lens: Tempered Glass
- LED Module: Power LED
- LED life duration: 100.000 hrs
- Specifications: 10W-710LM-6000K-1300Lux
- Light Colors: White
- Housing: Aluminum
- Mounting Types: Machinery
- Does not affected by water, dust, heat and UV rays
- Warranty: 2 Years

Voltage Options:

Option 1: 24V AC/DC



24V AC/DC

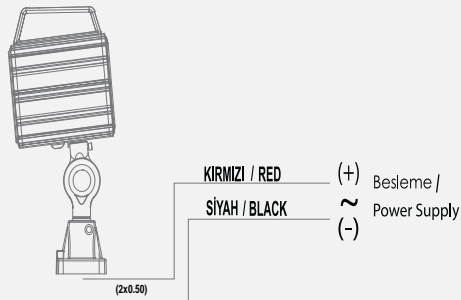

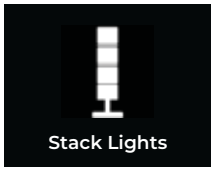

Machine Tool Light

MK1 Series Machine tool light

Power: 10W
Power Supply: 24V AC/DC

Light Colors: White
Light Shape: Point
Housing: Aluminium
Protection Rate: IP67

Part no.	Power Supply	Color
SNT-MK1	24V AC/DC	White

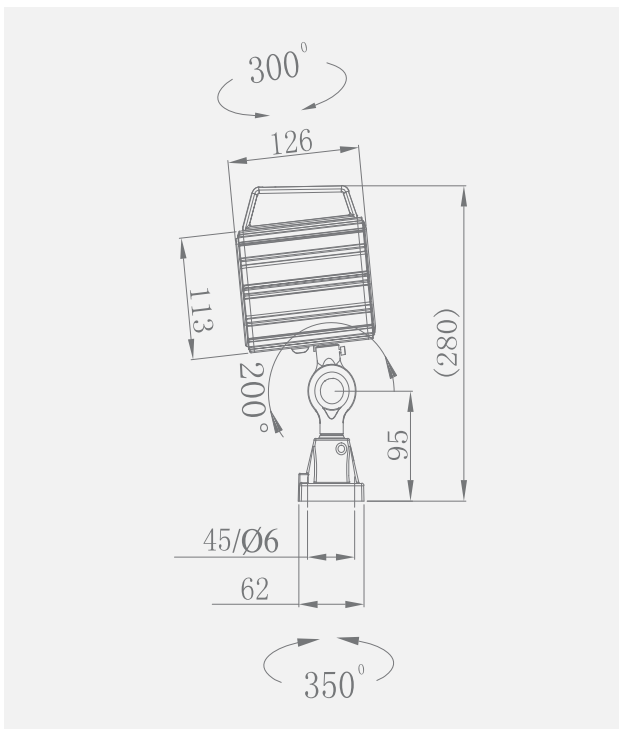

Machine Tool Light

MK2 Series Machine tool light

Power: 10W
Power Supply: 24V AC/DC

Light Colors: White
Light Shape: Point
Housing: Aluminium
Protection Rate: IP67

Part no.	Power Supply	Color
SNT-MK2	24V AC/DC	White

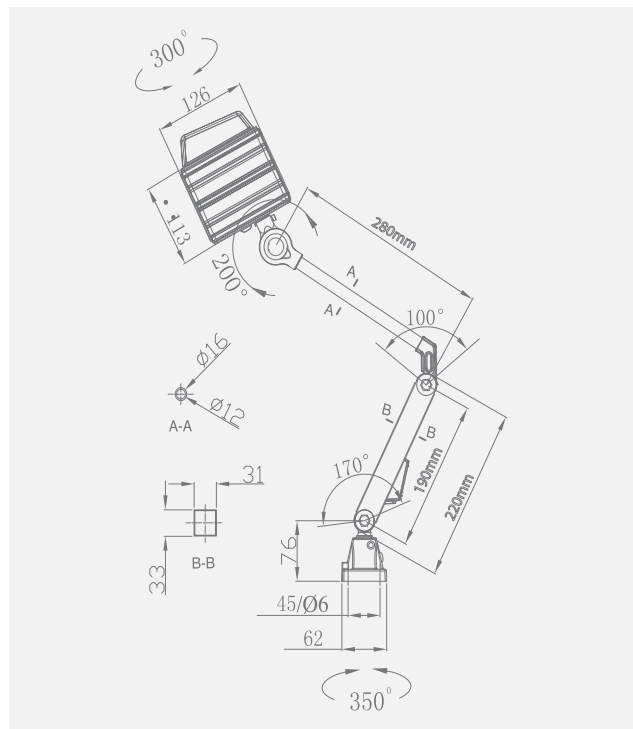



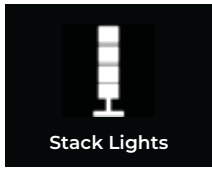

BL182 Forklift Safety Lights

PART NO	LIGHT SHAPE	LIGHT COLOR	POWER SUPPLY
SNT-BL182-1	Point	Red	10-60V/DC
SNT-BL182-4	Point	Blue	10-48V/DC

RL183 Forklift Safety Lights

PART NO	LIGHT SHAPE	LIGHT COLOR	POWER SUPPLY
SNT-RL183-1	Line	Red	10-48V/DC

RL181 Forklift Safety Lights

PART NO	LIGHT SHAPE	LIGHT COLOR	POWER SUPPLY
SNT-RL181-1	Line	Red	10-80V/DC
SNT-RL181-4	Line	Blue	10-80V/DC

UL181 Forklift Safety Lights

PART NO	LIGHT SHAPE	LIGHT COLOR	POWER SUPPLY
SNT-UL181-1	U-Shape	Red	10-80V/DC
SNT-UL181-4	U-Shape	Blue	10-80V/DC

BL184 Crane Safety Lights

PART NO	LIGHT SHAPE	LIGHT COLOR	POWER SUPPLY
SNT-BL184-1	Point	Red	10-48V/DC
SNT-BL184-4	Point	Blue	10-48V/DC

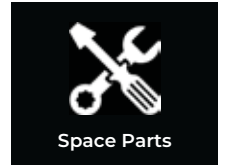

BL186 Crane Safety Lights

PART NO	LIGHT SHAPE	LIGHT COLOR	POWER SUPPLY
SNT-BL186-1	Point	Red	10-30V/DC
SNT-BL186-4	Point	Blue	10-30V/DC

BL188 Crane Safety Lights

PART NO	LIGHT SHAPE	LIGHT COLOR	POWER SUPPLY
SNT-BL188-1	Point	Red	10-30V/DC
SNT-BL188-4	Point	Blue	10-30V/DC

Machine Tool Lights

PART NO	LIGHT SHAPE	LIGHT COLOR	POWER SUPPLY
SNT-MK1	Point	White	24V AC/DC
SNT-MK2	Point	White	24V AC/DC





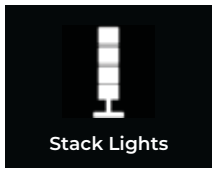

SL190 Series Motor Sirens



Max. Duration of Use: 3min

PART NO	SNT-SL190-13	SNT-SL190-22
Power Supply	24V/DC	220V/AC
Power Output	40W	40W
Current	2,50A	0,50A
Cycle	1000RPM	1000RPM
Housing	Metal	Metal
Volume	108dB	108dB
Prot.rate	IP44	IP44
Frequency	50/60Hz	50/60Hz

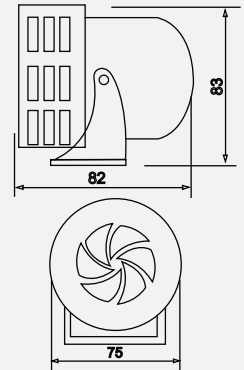

SL290 Series Motor Sirens



Max. Duration of Use: 3min

PART NO	SNT-SL290-13	SNT-SL290-22
Power Supply	24V/DC	220V/AC
Power Output	40W	40W
Current	3A	0,80A
Cycle	5000RPM	5000RPM
Housing	Metal-Plastic	Metal-Plastic
Volume	112dB	112dB
Prot.rate	IP44	IP44
Frequency	50/60Hz	50/60Hz

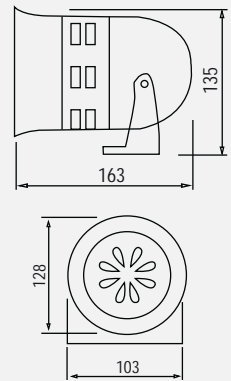

SL390 Series Motor Sirens



Max. Duration of Use: 3min

PART NO	SNT-SL390-13	SNT-SL390-22
Power Supply	24V/DC	220V/AC
Power Output	65W	65W
Current	3A	0,65A
Cycle	10000RPM	10000RPM
Housing	Metal	Metal
Volume	130dB	130dB
Prot.rate	IP44	IP44
Frequency	50/60Hz	50/60Hz

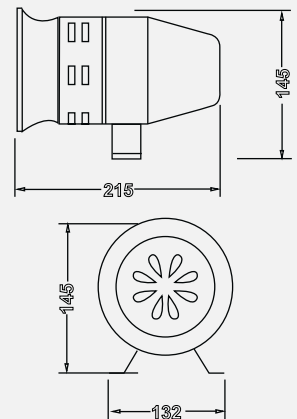



Obstruction Lights



Heavy Duty Lights



Safety Lights



Machine Tool Lights



Motor Sirens



Space Parts

MOTOR SIRENS

Motor sirens designed to give an effective warning over wide areas. The powerful low-frequency sound is ideal for covering long distances and is instantly recognizable.

For more Details
Scan the QR Code for more information
about the product

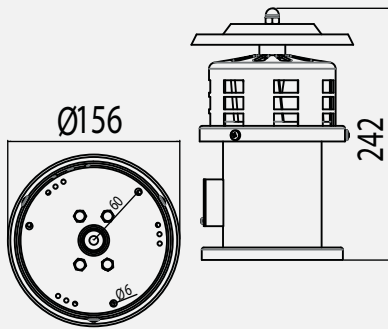

SL122 Series Motor Sirens

PART NO	SNT-SL122
Power Supply	220V/AC
Power Output	250W
Current	1,25A
Cycle	16000RPM
Housing	Metal
Volume	105dB
Prot.rate	IP40
Frequency	50Hz



Max. Duration of Use: 3min

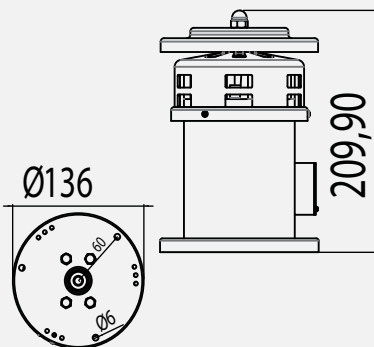

SL222 Series Motor Sirens

PART NO	SNT-SL222
Power Supply	220V/AC
Power Output	300W
Current	1,50A
Cycle	12000RPM
Housing	Metal
Volume	110dB
Prot.rate	IP40
Frequency	50Hz



Max. Duration of Use: 3min

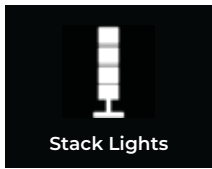

Stack Lights



RGB Warning Lights



Signal Beacons



LED Warning Horns



Beacon Horns



Electronic Sirens

SL322 Series Motor Sirens



Max. Duration of Use: 3min

PART NO	SNT-SL322
Power Supply	220V/AC
Power Output	350W
Current	1,70A
Cycle	8000RPM
Housing	Metal
Volume	115dB
Prot.rate	IP44
Frequency	50Hz

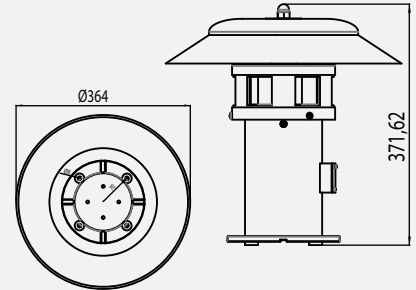

SL422 Series Motor Sirens



Max. Duration of Use: 3min

PART NO	SNT-SL422
Power Supply	220V/AC
Power Output	300W
Current	1,70A
Cycle	6000RPM
Housing	Metal
Volume	120dB
Prot.rate	IP44
Frequency	50Hz

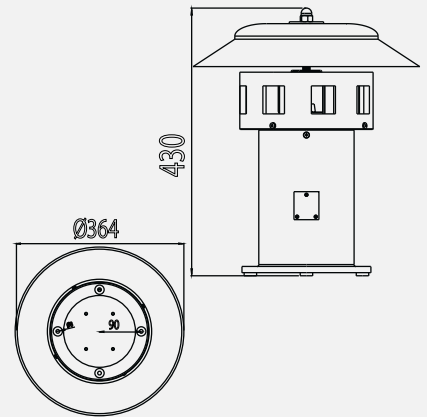

SL522 Series Motor Sirens



Max. Duration of Use: 3min

PART NO	SNT-SL522
Power Supply	220V/AC
Power Output	350W
Current	1,80A
Cycle	4500RPM
Housing	Metal
Volume	130dB
Prot.rate	IP44
Frequency	50Hz

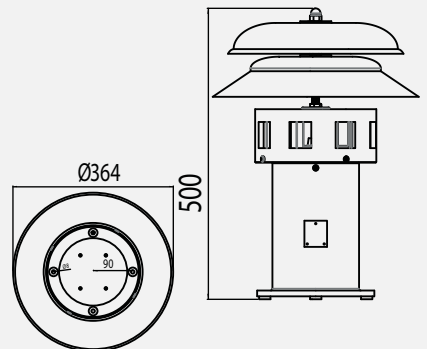

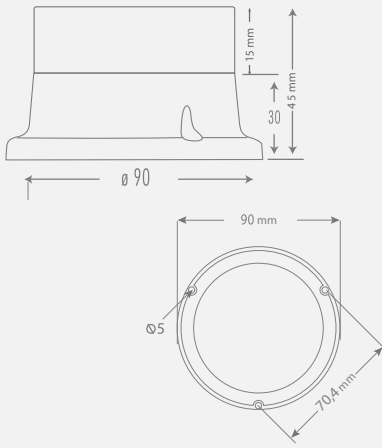

Led Warning Siren

PART NO	SNT-M725RL	SNT-M715RL
Power Supply	220V	12-24V
Current	95mA	150mA
Housing	ABS/PC	ABS/PC
Volume	100dB	100dB
Prot.rate	IP65	IP65

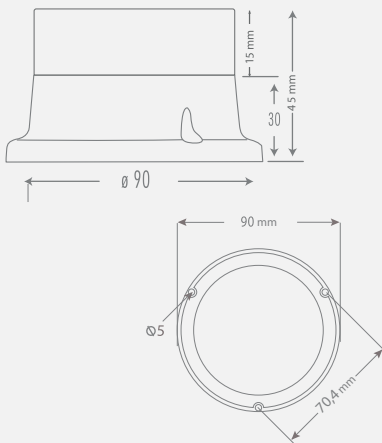

Warning Siren

PART NO	SNT-M725R	SNT-M715R
Power Supply	220V	12-24V
Current	95mA	150mA
Housing	ABS	ABS
Volume	91dB	91dB
Prot.rate	IP65	IP65

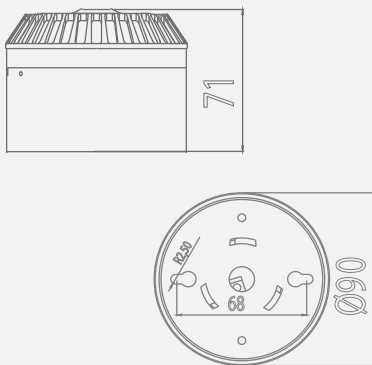

LED Fire Alarm Siren

PART NO	SNT-SLF90-22	SNT-SLF90-24
Power Supply	220V/AC	24V/DC
Power		0,96W
Current	98mA	40mA
Housing	ABS	ABS
Volume	90-100dB	90-100dB
Prot.rate	IP21	IP21

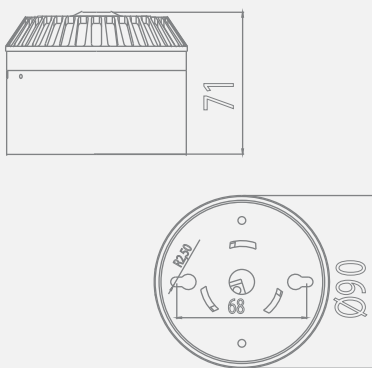

Fire Alarm Siren

PART NO	SNT-SL90-22	SNT-SL90-24
Power Supply	220V/AC	24V/DC
Power		0,48W
Current	50mA	20mA
Housing	ABS	ABS
Volume	90-100dB	90-100dB
Prot.rate	IP21	IP21









Stack Lights



RGB Warning Lights



Signal Beacons



LED Warning Horns

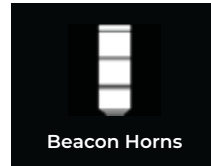

Beacon Horns



Electronic Sirens



Ø125 PC-Lens

Category: 125 series
Part No: SNT-125LNK



Ø125 PC-Lens

Category: 125 series
Part No: SNT-125LNY



Ø125 PC-Lens

Category: 125 series
Part No: SNT-125LNS



Ø125 PC-Lens

Category: 125 series
Part No: SNT-125LNM



Ø125 PC-Lens

Category: 125 series
Part No: SNT-125LNB



Ø100 PC-Lens

Category: 100 series
Part No: SNT-100LNK



Ø100 PC-Lens

Category: 100 series
Part No: SNT-100LNY



Ø100 PC-Lens

Category: 100 series
Part No: SNT-100LNS



Ø100 PC-Lens

Category: 100 series
Part No: SNT-100LNM



Ø100 PC-Lens

Category: 100 series
Part No: SNT-100LNB



Ø90 PC-Lens

Category: 90 series
Part No: SNT-90LNK



Ø90 PC-Lens

Category: 90 series
Part No: SNT-90LNY



Ø90 PC-Lens

Category: 90 series
Part No: SNT-90LNS



Ø90 PC-Lens

Category: 90 series
Part No: SNT-90LNM



Ø90 PC-Lens

Category: 90 series
Part No: SNT-90LNB



Ø70 PC-Lens

Category: 70 series
Led&Beacon Horns
Part No: SNT-YB70LNK



Ø70 PC-Lens

Category: 70 series
Led&Beacon Horns
Part No: SNT-YB70LNY



Ø70 PC-Lens

Category: 70 series
Led&Beacon Horns
Part No: SNT-YB70LNS



Ø70 PC-Lens

Category: 70 series
Led&Beacon Horns
Part No: SNT-YB70LNM



Ø70 PC-Lens

Category: 70 series
Led&Beacon Horns
Part No: SNT-YB70LNB



Obstruction Lights



Heavy Duty Lights



Safety Lights



Machine Tool Lights



Motor Sirens



Space Parts

Cover Code
SNT-70KPK



Ø70 PC-Lens

Category: 70 Stack
Lights
Part No: SNT-70LNK

Cover Code
SNT-70KPY



Ø70 PC-Lens

Category: 70 Stack
Lights
Part No: SNT-70LNY

Cover Code
SNT-70KPS



Ø70 PC-Lens

Category: 70 Stack
Lights
Part No: SNT-70LNS

Cover Code
SNT-70KPM



Ø70 PC-Lens

Category: 70 Stack
Lights
Part No: SNT-70LNM

Cover Code
SNT-70KPB



Ø70 PC-Lens

Category: 70 Stack
Lights
Part No: SNT-70LNB



Ø70 PC-Lens

Category: 70 RGB series
Part No: SNT-M70-SLN



Ø70 PC-Lens

Category: 70 RGB series
Part No: SNT-70-SLN



Ø90 PC-Lens

Category: 90 RGB series
Part No: SNT-90-SLN



Ø100 PC-Lens

Category: 100 RGB series
Part No: SNT-100-SLN



Ø70 Mini PC-Lens

Category: 70 series
Part No: SNT-M70-LNK



Ø70 Mini PC-Lens

Category: 70 series
Part No: SNT-M70-LNY



Ø70 Mini PC-Lens

Category: 70 series
Part No: SNT-M70-LNS



Ø70 Mini PC-Lens

Category: 70 series
Part No: SNT-M70-LNB



Ø70 Mini PC-Lens

Category: 70 series
Part No: SNT-M70-LNB



Ø70 ABS Cover

Category: Electronic Sirens
Part No: SNT-M70K



Ø70 PC Cover

Category: Electronic Sirens
Part No: SNT-70K



Stack Lights



RGB Warning Lights



Signal Beacons



LED Warning Horns



Beacon Horns



Electronic Sirens



Strobe-Rotary Led Module (RED)

Category: 70 series
Part No: SNT-LKP



Strobe-Rotary Led Module (GREEN)

Category: 70 series
Part No: SNT-LYP



Strobe-Rotary Led Module (YELLOW)

Category: 70 series
Part No: SNT-LYP



Strobe-Rotary Led Module (BLUE)

Category: 70 series
Part No: SNT-LMP



Strobe-Rotary Led Module (WHITE)

Category: 70 series
Part No: SNT-LBP



Steady Led Module (RED)

Category: 70 series
Part No: SNT-LK



Steady Led Module (GREEN)

Category: 70 series
Part No: SNT-LY



Steady Led Module (YELLOW)

Category: 70 series
Part No: SNT-LS



Steady Led Module (BLUE)

Category: 70 series
Part No: SNT-LM



Steady Led Module (WHITE)

Category: 70 series
Part No: SNT-LB



Metal Wall Bracket

Category: Obstruction light Series
Part No: SNT-125L



Metal Surface Bracket

Category: Obstruction light Series
Part No: SNT-125TB



ABS Surface Bracket

Category: ø70 Stack Lights
Part No: SNT-70TB



ABS Foldable Base

Category: ø70 Stack Lights
Part No: SNT-70D



ABS Wall Bracket

Category: ø70 Stack Lights
Part No: SNT-70L



Wall Bracket

Category: ø125 Series
Part No: SNT-125LT



Wall Bracket

Category: ø100 Series
Part No: SNT-100LT



Wall Bracket

Category: ø90 Series
Part No: SNT-90LT



Wall Bracket

Category: ø70 Series
Part No: SNT-70LT



Wall Bracket

Category: ø70 Stack Light
Part No: SNT-70LT



Wall Bracket

Category: øNUT-CONNECT
Part No: SNT-72LT



Protection Cage

Model ID: ø125 Series
Part No: SNT-125KFS



Protection Cage

Model ID: ø100 Series
Part No: SNT-100KFS



Protection Cage

Model ID: ø90 Series
Part No: SNT-90KFS



Extension Tube

Model ID: ø70 Stack Lights
Part No: SNT-30U
Part No: SNT-20U
Part No: SNT-10U



Extension Tube

Model ID: ø70 NUT-CONNECT
Part No: SNT-30RTB
Part No: SNT-20RTB
Part No: SNT-10RTB



Led Module

PART NO	TYPE	CATEGORY	COLOR
SNT-LK	Continuous Led Module	70 Stack Light	Red
SNT-LY	Continuous Led Module	70 Stack Light	Green
SNT-LS	Continuous Led Module	70 Stack Light	Yellow
SNT-LM	Continuous Led Module	70 Stack Light	Blue
SNT-LB	Continuous Led Module	70 Stack Light	White
SNT-LKP	Strobe-Rotary Led Module	70 Stack Light	Red
SNT-LYP	Strobe-Rotary Led Module	70 Stack Light	Green
SNT-LSP	Strobe-Rotary Led Module	70 Stack Light	Yellow
SNT-LMP	Strobe-Rotary Led Module	70 Stack Light	Blue
SNT-LBP	Strobe-Rotary Led Module	70 Stack Light	White



Cover

PART NO	TYPE	CATEGORY	COLOR
SNT-70KPK	Ø70 PC-Lens Cover	70 Stack Light	Red
SNT-70KPY	Ø70 PC-Lens Cover	70 Stack Light	Green
SNT-70KPS	Ø70 PC-Lens Cover	70 Stack Light	Yellow
SNT-70KPM	Ø70 PC-Lens Cover	70 Stack Light	Blue
SNT-70KPB	Ø70 PC-Lens Cover	70 Stack Light	Transparent
SNT-M70K	Ø70 ABS Lens Cover	Electronic Siren	Black
SNT-70K	Ø70 PC-Lens Cover	Electronic Siren	Black



Cover

PART NO	TYPE	CATEGORY	COLOR
SNT-90KFS	ø90 Metal Protection Cager	90 Series	Black
SNT-100KFS	ø100 Metal Protection Cage	90 Series	Black
SNT-125KFS	ø125 Metal Protection Cage	Obstruction Lights/Heavy Duty	Black

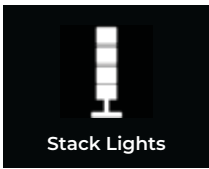

Stack Lights



RGB Warning Lights



Signal Beacons



LED Warning Horns



Beacon Horns



Electronic Sirens



Lens

PART NO	TYPE	CATEGORY	COLOR
SNT-M70LNK	Ø70 Mini PC-Lens	Mini Series	Red
SNT-M70LNY	Ø70 Mini PC-Lens	Mini Series	Green
SNT-M70LNS	Ø70 Mini PC-Lens	Mini Series	Yellow
SNT-M70LNM	Ø70 Mini PC-Lens	Mini Series	Blue
SNT-M70LNB	Ø70 Mini PC-Lens	Mini Series	Transparent
SNT-70LNK	Ø70 PC-Lens	70 Stack Light	Red
SNT-70LNY	Ø70 PC-Lens	70 Stack Light	Green
SNT-70LNS	Ø70 PC-Lens	70 Stack Light	Yellow
SNT-70LNM	Ø70 PC-Lens	70 Stack Light	Blue
SNT-70LNB	Ø70 PC-Lens	70 Stack Light	Transparent
SNT-YB70LNK	Ø70 PC-Lens	70 Series	Red
SNT-YB70LNY	Ø70 PC-Lens	70 Series	Green
SNT-YB70LNS	Ø70 PC-Lens	70 Series	Yellow
SNT-YB70LNM	Ø70 PC-Lens	70 Series	Blue
SNT-YB70LNB	Ø70 PC-Lens	70 Series	Transparent
SNT-90LNK	Ø90 PC-Lens	90 Series	Red
SNT-90LNY	Ø90 PC-Lens	90 Series	Green
SNT-90LNS	Ø90 PC-Lens	90 Series	Yellow
SNT-90LNM	Ø90 PC-Lens	90 Series	Blue
SNT-90LNB	Ø90 PC-Lens	90 Series	Transparent
SNT-100LNK	Ø100 PC-Lens	100 Series	Red
SNT-100LNY	Ø100 PC-Lens	100 Series	Green
SNT-100LNS	Ø100 PC-Lens	100 Series	Yellow
SNT-100LNM	Ø100 PC-Lens	100 Series	Blue
SNT-100LNB	Ø100 PC-Lens	100 Series	Transparent
SNT-125LNK	Ø125 PC-Lens	125 Series	Red
SNT-125LNY	Ø125 PC-Lens	125 Series	Green
SNT-125LNS	Ø125 PC-Lens	125 Series	Yellow
SNT-125LNM	Ø125 PC-Lens	125 Series	Blue
SNT-125LNB	Ø125 PC-Lens	125 Series	Transparent
SNT-M70-SLN	Ø70 Mini PC-Lens	70 RGB Series	Cloudy
SNT-70-SLN	Ø70 PC-Lens	70 RGB Series	Cloudy
SNT-90-SLN	Ø90 PC-Lens	90 RGB Series	Cloudy
SNT-100-SLN	Ø100 PC-Lens	100 RGB Series	Cloudy



Obstruction Lights



Heavy Duty Lights



Safety Lights



Machine Tool Lights



Motor Sirens



Space Parts



Mounting Parts

PART NO	TYPE	CATEGORY	COLOR
SNT-70TB	ABS Surface Bracket	70 Series	Black
SNT-70D	ABS Foldable Base	70 Series	Black
SNT-70L	ABS Wall Bracket	70 Series	Black
SNT-70TLT	Metal Wall Bracket	70 Series	Black
SNT-72LT	ø 70 Metal Wall Bracket-Nut-Conn.	70 Series	Black
SNT-70LT	ø70 Metal Wall Bracket	70 Series	Black
SNT-90LT	ø90 Metal Wall Bracket	90 Series	Black
SNT-100LT	ø100 Metal Wall Bracket	100 Series	Black
SNT-125LT	ø125 Metal Wall Bracket	125 Series	Black
SNT-10U	10cm Metal Tube Nut-Conn.	70 Series	Gray
SNT-20U	20cm Metal Tube Nut-Conn.	70 Series	Gray
SNT-30U	30cm Metal Tube Nut-Conn.	70 Series	Gray
SNT-10RTB	10cm Metal Tube Nut-Conn.	70 Nut-Con. Series	Gray
SNT-20RTB	20cm Metal Tube Nut-Conn.	70 Nut-Con. Series	Gray
SNT-30RTB	30cm Metal Tube Nut-Conn.	70 Nut-Con. Series	Gray
SNT-125L	Metal Casting Wall Bracket	Obstruction Light	Gray
SNT-125TB	Metal Casting Surface Bracket	Obstruction Light	Gray

“We are here with all our strength to realize the dream of a “sustainable and smart **industry**” by presenting the future-oriented power of **warning lights** to the sector.”

“Our Aim Is Warning”



PRODUCT CATALOG

CONTACT

İkitelli O. S. B. Giyim Sanatkarları San. Sit. 2.Ada
C Blok No:122 34490 Başakşehir / İSTANBUL /
TURKEY

Tel : +90 212 292 47 48

Gsm : +90 539 854 10 23

Website : muccosignal.com

Email : sales@muccosignal.com