





# E/NTES

## Product Catalogue 2023



-  **Power Quality and Energy**
-  **Power Factor Correction**
-  **Electrical Measurement**
-  **Protection and Control**
-  **Remote Monitoring**



## Energy Efficiency for a Better Future

Energy is an indispensable part of our lives.

We need energy wherever there is life and people, especially for producing, living, heating, traveling.

The quality, efficiency, measurability, monitoring, and, most importantly management of energy are very significant. Effective and properly managed energy is so beneficial to our lives and the world.

As ENTES, we are a big family that passionately devoted to this business many years ago and works continuously for the efficient control and management of energy.

With our solutions providing for the special needs of infrastructure, buildings, and industry, we are constantly working to transform energy into a manageable concept so that the job in question can be done with the lowest cost and the highest efficiency.

Based on our own resources, we evaluate the needs of our customers, keep up with the technological developments in the world, and develop unique manageable energy solutions.

We offer new possibilities to the economy by developing new technologies, we manage the energy of our customers spread over hundreds of thousands points around the world every day and ensure that they use them efficiently.

We work for a sustainable future with our universal values in order to offer manageable, energy-oriented and more beneficial solutions. In order to ensure that energy is controllable and sustainable in all areas where energy can be managed, and at the same time to create value for our customers, ENTES;

“Wherever the energy is, it is a 100% domestic capital technology company that offers solutions to enable more measurable, traceable, and manageable energy.”



## Power Quality & Energy

EMR Series Network Analyzers .....	4
MPR-4 Series Network Analyzers .....	6
EMK Series Power Quality Analyzers .....	8
MPR - 1 Series Network Analyzers .....	10
MPR - 2 Series Network Analyzers .....	12
MPR - 3 Series Network Analyzers .....	14
ES Series Power and Energy Meters .....	16
ES3 Series Power and Energy Meters .....	17



## Energy Management Solutions

ENTES Energy Management Solutions .....	61
EnerMedic and Enerthings .....	63
ETMO Series Modems .....	67
GEMO Series Modems .....	68
EPC-12 Pulse Concentrator .....	69

## Electrical Measurement

EMM Series Multimeters .....	21
EPM-04 EPM-06 EVM-05 Series Multimeters .....	23
EPM-4 Series Ammeters .....	25
EPM-R Series Ammeters .....	25
EVM Series Voltmeters .....	27
ECR Series Cosφ Meters .....	28
EFC Series Frequency Meters .....	28
TA Series Current Transducers .....	29
TV Series Voltage Transducers .....	30
DCA Series Ammeters .....	31
DC Shunts .....	32
DCV Series Voltmeters .....	33



## Compensation

RGI Series Reactive Power Control Relay .....	73
RGP Series Reactive Power Control Relay .....	74
RGA Series Reactive Power Control Relay .....	75
RGSR Series Reactive Power Control Relay .....	76
RGA / RGSR OG Series Reactive Power Control Relay .....	77
SR Series Inductive Load Drivers .....	78
M.V. Compatible Current Transformers .....	79
Low Voltage Power Capacitors .....	80
DU-3 Discharge Unit .....	84
ENT.SRS Series Shunt Reactors .....	85
ENT.ERH Series Harmonic Filter Reactors .....	88
ENT-KT Series Compensation Contactors .....	92
Load Disconnecter .....	94
NH Blade Fuses .....	95
SC Series Static Contactors .....	96
SPD Series Surge Protection Device .....	97
ENT.A Series LV Current Transformers .....	98
ENS Series LV Current Transformers .....	104
ENS.3PM Series & LV Current Transformers .....	105
ENS.CCT Series A.G Clamp Type Current Transformers .....	107
CT Series Current Transformers .....	108

## Protection & Control

MKC - MKS Series Motor (Phase) Protection Relays .....	36
FR-02 / PT-01 Phase Sequence Relay / Thermistor Relay .....	38
GKRC / DGRC / MCC Series Voltage Protection Relays .....	39
AKC Series Current Protection Relays .....	40
CKR Series Overcurrent Secondary Protection Relays .....	41
MCB / SER / ERTC / SSR / DG Series Time Relays .....	42
MCB-100/200 ERTC-100 Series Time Relays .....	44
DTR Series Astronomical Time Relays .....	46
MCB-50/50T Series Programmable Time Clocks .....	48
MCB-A Series Programmable Time Clocks .....	48
SSRC Series Liquid Level Controllers .....	50
FG Series Photocell Relays .....	51
PS Series Power Supplies .....	52
ENT.PST Series Control Transformers .....	56
ENT.IST Series Isolation Transformers .....	59





# Power Quality and Energy Efficiency

The products in "ENTES Power Quality and Energy" group are designed to measure various electrical parameters. With their communication features all measurements can be tracked from a single monitoring center. Energy quality and efficiency analysis can be performed with network analyzers in electrical distribution/transmission system, such as industrial facilities and buildings

## Network Analyzers

- EMR Series
- MPR-1 Series
- MPR-2 Series
- MPR-3 Series
- MPR-4 Series
- EPM-07 Series

## Power Quality Analyzers

- EMK Series

## Power and Energy Meters

- ES Series
- ES3 Series
- EPR Series

## Network Analyzers (LED Display)



## EMR Series

EMR-53 / EMR-07 Series Network Analyzers provide you to monitor more than 50 electrical parameters on the screen.

**EMR-04** : Power Energy Meter

**EMR-07** : Network Analyzer

**EMR-07S** : Network Analyzer with RS-485 (MODBUS) Communication

**EMR-53** : Network Analyzer Measuring THD

**EMR-53S** : Network Analyzer with RS-485 (MODBUS) communication, Pulse Counters, Digital Timer, Alarm Contacts

## Remote Monitoring Software EnerMedic

Thanks to EnerMedic Energy Management Software developed by ENTES, the measured values can be read remotely and energy consumption and quality can be monitored in real time.

In this way, comprehensive energy monitoring, data storage, the analysis of the data stored can be optimized. Control of energy consumption by analyzing data gives an opportunity to decrease the energy costs and achieve the sustainable energy targets.

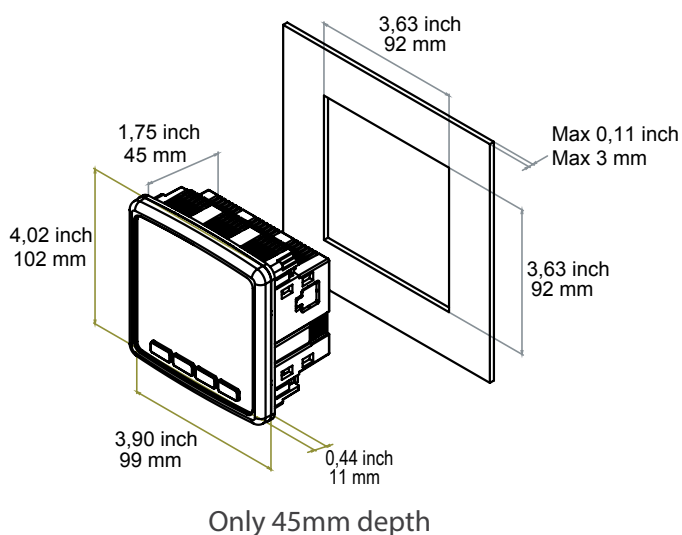

## Benefits

EMR Series Energy Analyzers allows the electrical measurements to be read clearly in any environment. EMR Series Energy Analyzers make a difference with its 45mm depth while save time by ghost screen technology and easy mounting features.



## Applications

Wide variety of models and features in EMR Series Energy Analyzers will provide you the analysis of energy parameters in any project you are in.

## Network Analyzers (LED Display)



### Product Selection Table

Product Code	3-Phase Voltage, 3-Phase Current, Frequency	W, Var, VA	kWh, kVAh	Cosφ	THDV/THDI	Individual Harmonics	Digital Input	Digital Output	Contact Output	Neutral Current	Demand	Max./Min. Values	Under/Over Voltage Protection	Phase Sequence Protection	RS-485	Internal Memory	X/1, X/5 Current Transformer	Total Operation Time	Supply Voltage	
EMR-04		●	●	●			2	2			●	●						●	●	100-270 VAC/VDC
EMR-04S		●	●	●			2	2			●	●			●	2MB		●	●	100-270 VAC/VDC
EMR-07	●	●	●	●			2	2			●	●						●		100-270 VAC/VDC
EMR-07S	●	●	●	●	●		2	2			●	●			●	2MB		●	●	100-270 VAC/VDC
EMR-53	●	●	●	●	●	15	2	2	●	●	●	●						●		100-270 VAC/VDC
EMR-53S	●	●	●	●	●	31	2	2	●	●	●	●			●	2MB		●	●	100-270 VAC/VDC
EMR-53CS	●	●	●	●	●	31	2	2	●	●	●	●	●	●	●	2MB		●	●	100-270 VAC/VDC



### Measured Parameters

EMR-53 Models	EMR-07 Models	EMR-04 Models	Total Active Power ( $\Sigma P$ )	Active Power (P)	Inductive Reactive Energy (kVAh)
			Total Reactive Power ( $\Sigma Q$ )	Reactive Power(Q)	Capacitive Reactive Energy (kVAh)
			Total Apparent Power ( $\Sigma S$ )	Apparent Power(S)	Apparent Energy (kVAh)
			Active Energy - Import (kWh)	Cosφ	Maximum Demand
			Active Energy - Export (kWh)		Maximum/Minimum Values
			Phase-Neutral Voltages(VLN)	Phase Currents	
			Phase-Phase Voltages(VLL)	Calculated Neutral Current	
			THDV/THDI		
			Individual Harmonics		



See page 63 for energy monitoring software.



“ EMR Series Energy Analyzers gather innovation, functionality and competitive features in one design and stand out in integrated energy management, energy efficiency and energy measurement projects.

”

**Network Analyzers (LCD Display)**



**MPR-4 Series Network Analyzer**

With their compact design and 45mm depth, MPR-4 Series New Generation Network Analyzers occupy less space in the panels. Real-time monitoring is possible via large graphic screen. In addition up to 16 MB internal memory and communication feature they offer wide I/O solutions with their replaceable modular structure based on customer requirements and areas of application.

**I/O Modules**

MPR-4 Series Network Analyzers can be customized by installing I/O modules based on project requirements.



MPR-4X I/O Module Selection Table
MM-120 (2 Digital Input, 5-24 VDC)
MM-102 (2 Digital Output, 5-24 VDC)
MM-002 (2 Relays, 5A /250 VAC; NO)
MM-122 (2 Digital Inputs + 2 Digital Outputs, 5-24 VDC)
MM-202 (2 Analog Outputs, (0-10VDC)(0-5VDC)(±5 VDC)(±10VDC)(0-20mA)(0-24mA)(4-20mA)
MM-144 (4 Digital Inputs + 4 Digital Outputs 5-24 VDC)

MPR-4X-OG and MPR-4X-PM I/O Module Selection Chart
MM-OG-26 (2 Digital Inputs, 2 Digital Outputs, 2 Relays, 2 Analog Outputs)



**Increase Your Efficiency by Monitoring Your Energy Remotely**

See page 63 for energy monitoring software.



**Benefits**

MPR-4 takes up less space in the cabinet by its 45 mm depth. MPR-4 range offers wide operating voltage options and can be customized with wide I/O solutions compatible with its modular structure.



**Applications**

Projects require flexibility of modular I/O extension, easy and fast installations, record of sag and swell, detailed harmonics are the ideal applications for MPR -4 series energy analyzers.

## Network Analyzers (LCD Display)



### Product Comparison Chart

Product Name	Dimensions/mm	3xV, 3xI, Frequency, W, VAR, VA, ΣP, ΣQ, ΣS, kWh, kVArh, Demand, Max., Min. Cosp, I nötr	Active Energy Class 0,5	Active Energy Class 1	% THD-I / % THD-V	Neutral Current Input Individual Harmonics	RS-485	Ethernet	Digital Input	Digital Output	Analog Output	Relay Output (Alarm Contact)	Clock (RTC)	Memory (MB)	Current-Voltage Unbalances	Tariff	Pulse Counter	Çalışma Saati	Alarm	Event Recording	Log Recording	Constant Current Terminals	X/5, X/1	X/333 mV	24-60 VAC/DC	50-270 VAC/DC
<b>50-270 VAC/DC Supply</b>																										
MPR-45	96x96	●	●	●					*	*	*	*	●			1	*	●	*	●			●		●	
MPR-45S	96x96	●	●	●			●		*	*	*	*	●	16		1	*	●	*	●	●		●		●	
MPR-46	96x96	●	●	●	●				*	*	*	*	●			1	*	●	*	●			●		●	
MPR-46S	96x96	●	●	●	●		●		*	*	*	*	●	16		8	*	●	*	●	●		●		●	
MPR-46S-PM	96x96	●	●	●			●		*	*	*	*	●	16		8	*	●	*	●	●		C	●	●	
MPR-47S	96x96	●	●	●		51	●		*	*	*	*	●	16	●	8	*	●	*	●	●		●		●	
MPR-47S-0,5	96x96	●	●	●		51	●		*	*	*	*	●	16	●	8	*	●	*	●	●		●		●	
MPR-47S-PM	96x96	●	●	●		51	●		*	*	*	*	●	16	●	8	*	●	*	●	●		C	●	●	
MPR-47SE	96x96	●	●	●		51	●	●	*	*	*	*	●	16	●	8	*	●	*	●	●		●		●	
MPR-47SE-0,5	96x96	●	●	●		51	●	●	*	*	*	*	●	16	●	8	*	●	*	●	●		●		●	
<b>24-60 VAC/DC Supply</b>																										
MPR-47S-D	96x96	●	●	●		51	●		*	*	*	*	●	16	●	8	*	●	*	●	●		●		●	
MPR-47S-D-0,5	96x96	●	●	●		51	●		*	*	*	*	●	16	●	8	*	●	*	●	●		●		●	
<b>OG Series (Constant Current Terminals)</b>																										
MPR-42-OGT-26	96x96	●	●	●		31	●		●	●	●	●	●	16		8	●	●	●	●	●	●	●	●	●	●
MPR-42-OGT-26-0,5	96x96	●	●	●		31	●		●	●	●	●	●	16		8	●	●	●	●	●	●	●	●	●	●
MPR-47S-OG	96x96	●	●	●		51	●		*	*	*	*	●	16	●	8	*	●	*	●	●	●	●	●	●	●
MPR-47S-OG-D	96x96	●	●	●		51	●		*	*	*	*	●	16	●	8	*	●	*	●	●	●	●	●	●	●
MPR-47S-OG-D-0,5	96x96	●	●	●		51	●		*	*	*	*	●	16	●	8	*	●	*	●	●	●	●	●	●	●

C can be used with X5/PM Converter. \*Modular Structure



### Measured Parameters

<b>MPR-45 MPR-45S</b>	Phase-Neutral Voltages ( $V_{LN}$ )	Neutral Current (In)	Active Power (P)	Active Energy- Import (kWh or MWh)
	Phase-Phase Voltages ( $V_{LL}$ )	Total Current ( $\Sigma I$ )	Reactive Power (Q)	Active Energy - Export (kWh or MWh)
	Average Phase - Neutral Voltage	Power Factor (PF)	Apparent Power (S)	Inductive Reactive Energy (kVArh or MVArh)
	Average Phase-Phase Voltage	Cosp	Total Active Power ( $\Sigma P$ )	Capacitive Reactive Energy (kVArh or MVArh)
	Maximum Demand	Frequency (Hz)	Total Reactive Power ( $\Sigma Q$ )	Apparent Energy (kVAh or MVAh)
	Phase Currents (IL)	Max / Min. Values	Total Apparent Power ( $\Sigma S$ )	Ground - Neutral Voltage (VEN)
<b>MPR-46 MPR-46S MPR-46S-PM</b>	Total Harmonics in Voltages Distortion (%THD-V)	Total Harmonic in Currents Distortion(%THD-I)		
<b>MPR-47S MPR-47S-D MPR-47S-0,5 MPR-47S-D-0,5 MPR-47S-PM MPR-47SE MPR-47SE-0,5</b>	Sag / Swell	Current / Voltage Unbalances	1-51. Voltage Harmonics	1-51. Current Harmonics



## Quality Analyzers



## EMK Series Class A Power Quality Analyzers

EMK-01 and EMK-10P Power Quality Analyzers enable the measurement of electrical parameters in LV and MV systems according to EN6100-4-30 Class A standard. It monitors and analyzes the quality of the energies on the distribution and consumption side of the networks according to the EN50160 standard in order to detect the problems in the system.

EMK-10P Power Quality Analyzers with 5 voltage and 4 current terminals can be used in various applications. Rogowski type clamps provide easy and fast connection wherever you need to analyze the power quality.

The portable form of quality



### Benefit

EMK-10P offers you a flexibility for your measurements in any environment and in any condition.



### Usage areas

They are equipment designed to meet all the needs of teams who want to measure power quality at multiple points.

## Quality Analyzers



### Product Comparison Chart

Product Name	Dimensions(mm)	Graphic LCD	3xV/I, Hz, W, Var, VA, ΣP/Q/S, kWh, kVArh, Max, Min, cosφ, I neutral	Active Energy Class 0.2S	Current / Voltage Unbalance	THD-V/I	Individual Harmonics	Sag/Swell	Transient	Fliker	K Factor	RS-485 Communication	Ethernet	Sıcaklık Sensörü	Digital Input / Output	Memory	Event/Log Recordings	X/5, X/1	230 VAC	85-265 VAC/DC	24-60 VAC/DC
EMK-01	144X144	●	●	●	●	●	64	●	●	●	●	●	●	●	2	1GB	●	●	●	○	○
EMK-10P	Portable Box	●	●	●	●	●	64	●	●	●	●	●	●	●	1GB	●	●	●	●	●	●

○ Optional



### Measured Parameters

EMK-01 EMK-10P	Phase-Neural Voltages ( $V_{LN}$ )	Active Power (P)	Total Harmonics in VoltagesDistortion (%THD-V)
	Phase-Phase Voltages ( $V_{LL}$ )	Reactive Power (Q)	Total Harmonic in CurrentsDistortion (%THD-I)
	Phase Currents (IL)	Apparent Power (S)	Current / Voltage Unbalances
	Neutral Current (In)	Total Active Power ( $\Sigma P$ )	1-64. Voltage Harmonics
	Total Current ( $\Sigma I$ )	Total Reactive Power ( $\Sigma Q$ )	1-64. Current Harmonics
	Power Factor (P.F)	Total Apparent Power ( $\Sigma S$ )	Sag / Swell
	cosφ	Active Energy- Import (kWh veya MWh)	Flicker
	Frequency (Hz)	Active Energy - Export (kWh veya MWh)	Transient
	Max / Min. Values	Inductive Reactive Energy (kVArh veya MVArh)	
		Capacitive Reactive Energy (kVArh veya MVArh)	
	Apparent Energy (kVAh veya MVAh)		



See page 63 for energy monitoring software.



“ EMK Series Energy Quality Analyzers, provides you the most detailed energy measurements in accordance with international standards. Fixed and portable versions provide you the flexibility wherever you need an energy analysis solution. ”

## Network Analyzers



## MPR - 1 Series Network Analyzers

MPR-1 Series DIN type network analyzers have been designed for the purpose of measurement of electrical parameters at machines and panels. By means of its design without a screen, it is a cost effective measurement device series for energy monitoring software.

## Remote Monitoring Software EnerMedic

Thanks to the energy management software developed by ENTES, the measured values can be read remotely and energy consumption and quality can be monitored in real time. In this way, comprehensive energy monitoring, data storage, the analysis of the data stored can be optimized. Control of energy consumption by analyzing data gives an opportunity to decrease the energy costs and achieve the sustainable energy targets.



**Increase Your Efficiency by Monitoring Your Energy Remotely**

See page 63 for energy monitoring software.



### Benefit

MPR-1 series Energy Analyzers are the optimum solution where project requires remote monitoring.



### Applications

MPR-1 Energy Analyzers are optimum solution for the projects require detailed harmonic measurements, remote energy analysis, record of current and voltage imbalances.

## Network Analyzers



### Product Comparison Chart

Product Code	Dimensions	% THD - I	% THD - V	Individual Harmonics	Current-Voltage Unbalances	RS-485 Modbus	Tariff	Digital Input	Digital Output	Analog Output (mA/V)	Relay Output	Pulse Counter	Memory	Log Recording	Event Recording	X5/X1 Current Transformer	95-270VAC/DC	12-50VDC
<b>95-270 VAC/DC Supply</b>																		
MPR-14S	DIN4					●	8								●	●	●	
MPR-15S-22	DIN4	●	●			●	8	2	2			●	4 MB	●	●	●	●	
MPR-16S-21	DIN4	●	●	51	●	●	8	2			1	●	4 MB	●	●	●	●	
MPR-17S-23	DIN4	●	●	51	●	●	8	2	2	1		●	4 MB	●	●	●	●	
<b>12-50 VDC Supply</b>																		
MPR-14S-D	DIN4					●	8								●	●		●
MPR-15S-22-D	DIN4	●	●			●	8	2	2			●	4 MB	●	●	●		●
MPR-16S-21-D	DIN4	●	●	51	●	●	8	2			1	●	4 MB	●	●	●		●
MPR-17S-23-D	DIN4	●	●	51	●	●	8	2	2	1		●	4 MB	●	●	●		●



### Measured Parameters

<b>MPR-14S</b>	Phase-Neural Voltages ( $V_{LN}$ )	Neutral Current ( $I_n$ )	Active Power (P)
	*Phase-Phase Voltages ( $V_{LL}$ )	Phase Currents ( $I_L$ )	Reactive Power (Q)
	Max / Min. Values	Total Active Power ( $\Sigma P$ )	Apparent Power (S)
	Power Factor (P.F)	Total Reactive Power ( $\Sigma Q$ )	Active Energy- Import (kWh or MWh)
	Cosp	Total Apparent Power ( $\Sigma S$ )	Active Energy - Export (kWh or MWh)
	Frequency (Hz)	Apparent Energy(kVAh or MVAh)	Inductive Reactive Energy (kVArh or MVArh)
	Demand / Maximum Demand		Capacitive Reactive Energy (kVArh or MVArh)
<b>MPR-15S-22</b>	Total Harmonics in VoltagesDistortion (%THD-V)	Total Harmonic in CurrentsDistortion (%THD-I)	
<b>MPR-16S-21</b> <b>MPR-17S-23</b>	Current / Voltage Imbalances	1-51. Voltage Harmonics	1-51. Current Harmonics



See page 63 for energy monitoring software.



“ ENTES MPR-1 Energy Analyzers cover all your basic requirements in the projects where the measurement data can be transferred by communication and without any need of screen on device. ”

## Network Analyzers(LCD)



## MPR - 2 Series Network Analyzers

MPR-2 Series have been designed for detailed measurement and analysis of electrical parameters. With their communication features all measurements can be tracked from a single monitoring center.

With its digital inputs and outputs, MPR-2 Series can detect and control the status of devices in the field (breakers, switches, contacts, etc.).

## Log Reader

By the help of free ENTES Log Reader Software, parameters such as; current, voltage, power, load profile and THD can be transferred to computer. The data is able to be filtered by time period and parameter type. The data stored can be exported in XLS, CSV, etc. formats.



**Current, voltage, power, load profile and THD values can be exported in different formats.**



### Benefit

MPR-2 Series with its digital inputs and outputs detect the status of devices in the field as well as control (breakers, switches, contacts, etc.).



### Application

MPR-2 Series Network Analyzers are ideal for the customers who aim to monitor electrical parameters on the screen, require detailed analysis of harmonic, current, voltage imbalances, log reading and quick installation.

## Network Analyzers(LCD)



### Product Comparison Chart

Product Name	3xV, 3xI, Frequency, W, VA, VA <sub>ΣP</sub> , ΣQ, ΣS, kWh, kVArh, Demand, Max., Min., Cosφ, I nötr	% THD-I	% THD-V	Individual Harmonics	RS-485	Digital Input	Digital Output	Analog Output	Relay Output (alarm contact)	Tariff	Clock(RTC)	Memory	Current-Voltage Unbalances	Pulse Counter	Run/On Hour	Alarm	Event Recording	Log Recording	X/5, X/1	X/333 mV	95-270 VAC/DC	12-50 VDC
<b>95-270 VAC/DC Supply</b>																						
MPR-24	●									1	●				●		●		●		●	
MPR-24-PM	●									1	●				●		●		C	●	●	
MPR-25S-22	●	●	●		●	2	2			8	●	4MB		●	●	●	●	●	●		●	
MPR-26S-21	●	●	●	51	●	2			1	8	●	4MB	●	●	●	●	●	●	●		●	
MPR-26S-21-PM	●	●	●	51	●	2			1	8	●	4MB	●	●	●	●	●	●	C	●	●	
MPR-27S-23	●	●	●	51	●	2	2	1		8	●	4MB	●	●	●	●	●	●	●		●	
<b>12-50 VDC Supply</b>																						
MPR-24-D	●									1	●				●		●		●		●	
MPR-24-D-PM	●									1	●				●		●		C	●	●	
MPR-25S-22-D	●	●	●		●	2	2			8	●	4MB		●	●	●	●	●	●		●	
MPR-26S-21-D	●	●	●	51	●	2			1	8	●	4MB	●	●	●	●	●	●	●		●	
MPR-26S-21-D-PM	●	●	●	51	●	2			1	8	●	4MB	●	●	●	●	●	●	C	●	●	
MPR-27S-23-D	●	●	●	51	●	2	2	1		8	●	4MB	●	●	●	●	●	●	●		●	

C It can be used with X5/PM converter.



### Measured Parameters

<b>MPR-24 MPR-24-PM</b>	Phase-Neural Voltages ( $V_{LN}$ )	Neutral Current (In)	Active Power (P)
	Phase-Phase Voltages ( $V_{LL}$ )	Phase Currents (IL)	Reactive Power (Q)
	Max / Min. Values	Total Active Power ( $\Sigma P$ )	Apparent Power (S)
	Power Factor (P.F)	Total Reactive Power ( $\Sigma Q$ )	Active Energy- Import (kWh or MWh)
	Cosφ	Total Apparent Power ( $\Sigma S$ )	Active Energy - Export (kWh or MWh)
	Frequency	Apparent Energy (kVAh or MVAh)	Inductive Reactive Energy (kVArh or MVArh)
	Demand / Maximum Demand		Capacitive Reactive Energy (kVArh or MVArh)
<b>MPR-25S-22</b>	Total Harmonics in Voltages Distortion (%THD-V)	Total Harmonic in Currents- Distortion (%THD-I)	
<b>MPR-26S-21 MPR-26S-21-PM MPR-27S-23</b>	Current / Voltage Imbalances	1-51. Voltage Harmonics	1-51. Current Harmonics



See page 63 for energy monitoring software.

## Network Analyzers(LCD)



## MPR - 3 Series Mini Network Analyzers

With 72x72x50mm size, MPR-3 Series Mini Network Analyzers occupy less space in the panel. They are preferred in rack type panels used in applications such as UPS, machine control panels, data processing and system rooms, and security control owing to their compact design. With their digital inputs and outputs, These MPR-3 Mini Network Analyzers can detect and control the status of the devices in the field (breakers, switches, contactors, etc.).

## Remote Monitoring Software

With the energy management software developed by ENTES, energy consumption and quality can be monitored in real time by reading the values measured by the devices. As a result, it is provided that monitoring comprehensive energy, data storage, analysis of stored data, optimum control of energy consumption, improvement of energy costs and sustainable targets of energy systems.



**With ENTES solutions, you are in control of your systems by remote monitoring.**



### Benefit

The MPR-3 Network Analyzers let you measure electrical parameters, detect the status of devices in the field and control (breakers, switch, contacts etc.).



### Application

MPR-3 Series Network Analyzers are optimum solution for the project requirements such as compactness, both LCD screen and remote monitoring, log reading, easy and fast

## Network Analyzers(LCD)



### Product Comparison Chart

Product Name	Dimensions/mm	3xV, 3xI, Frequency W, VAR, VA, ΣP, ΣQ, ΣS;kWh, kVArh, Demand, Max., Min. Cosφ, I nötr	% THD-I	% THD-V	RS-485	Digital Input	Digital Output	Clock (RTC)	Pulse Counter	Run/On Hou	Alarm	Event Recording*	Memory	X/5, X/1	X/333 mV	95-270 VAC/DC
MPR-32	72x72	●						●		●		●				●
MPR-34-11	72x72	●	●	●		1	1	●	●	●	●	●				●
MPR-34S-11	72x72	●	●	●	●	1	1	●	●	●	●	●	1MB	●		●
MPR-34S-11-PM	72x72	●	●	●	●	1	1	●	●	●	●	●	1MB	C	●	●
MPR-34-20	72x72	●	●	●		2		●	●	●		●		●		●
MPR-34S-20	72x72	●	●	●	●	2		●	●	●		●	1MB	●		●

Initial energizing, long interruption for interruptions lasting more than 3 seconds, alarm setting change, time change and reset.

C C can be used with X5/PM converter.



### Measured Parameters

MPR-32	Phase-Neural Voltages ( $V_{LN}$ )	Neutral Current ( $I_n$ )	Active Power (P)
	Phase-Phase Voltages ( $V_{LL}$ )	Phase Currents ( $I_L$ )	Reactive Power (Q)
	Max / Min. Values	Total Active Power ( $\Sigma P$ )	Apparent Power (S)
	Power Factor (P.F)	Total Reactive Power ( $\Sigma Q$ )	Active Energy- Import (kWh veya MWh)
	Cosφ	Total Apparent Power ( $\Sigma S$ )	Active Energy - Export (kWh veya MWh)
	Frequency (Hz)	Apparent Energy (kVAh veya MVAh)	Inductive Reactive Energy (kVArh veya MVArh)
	Demand / Maximum Demand		Capacitive Reactive Energy (kVArh veya MVArh)
MPR-34-11 MPR-34S-11 MPR-34-20 MPR-34S-20 MPR-34S-11-PM	Total Harmonics in VoltagesDistortion (%THD-V)	Total Harmonic in CurrentsDistortion	



See page 63 for energy monitoring software.



“ MPR-3 Series Network Analyzers with its unique 72x72 mm size are smart solution for UPS, machine control panels, data processing and system rooms, rack used in applications such as security control rooms, electrical panels thanks to its compact design. It is the ideal solution for the measurement and monitoring of electrical parameters. ”



## Power and Energy Meters



## ES Series

### ES-32L / ES-32LS / ES-45L / ES-45LS / ES-80L : Watt-Hour Meter

Compact, reliable and easy to install, the ES Series directly measures active kilowatt-hour (kWh) consumption. It also has an energy pulse output.

#### ES Series

It communicates via RS-485 port by keeping energy measurements in Modbus registers. The ES series has the MID certificate, which is accepted as the measurement standard in European countries.

### Product Comparison Chart

Product Name		Direct Current Measurement	CT-80D Current Transformer	MID Compatibility*	kWh Active Energy	Energy Pulse Output	RS-485 Communication
ES-32L	Digital Energy Meter (32A)	32A		<input type="radio"/>	<input checked="" type="radio"/>	<input checked="" type="radio"/>	
ES-32LS	Digital Energy Meter (32A)	32A		<input type="radio"/>	<input checked="" type="radio"/>		<input checked="" type="radio"/>
ES-45L	Digital Energy Meter (45A)	45A		<input type="radio"/>	<input checked="" type="radio"/>	<input checked="" type="radio"/>	
ES-45LS	Digital Energy Meter (45A)	45A		<input type="radio"/>	<input checked="" type="radio"/>		<input checked="" type="radio"/>
ES-80L	Digital Energy Meter (80A)	80A	<input checked="" type="radio"/>	<input type="radio"/>	<input checked="" type="radio"/>	<input checked="" type="radio"/>	
ES-80LS	Digital Energy Meter (80A)	80A	<input checked="" type="radio"/>	<input type="radio"/>	<input checked="" type="radio"/>		<input checked="" type="radio"/>

\*You can choose MID Compatible versions to read and invoice the products in question.

Optional



**Increase Your Efficiency by Monitoring Your Energy Remotely**

See page 63 for energy monitoring software.

### Benefit

The ES Series is designed to measure active energy consumption. They are compact, reliable, easy-to-install products. Their compliance with measurement standards is registered with MID certificate.

### Application

ES Series Energy Meters are ideal solution for any type of single-phase energy project provides you the flexibility by remote monitoring and pulse output features.

Power and Energy Meters

# ES3 Series

## 3 Phase Energy Meters



ENTES ES3 Series 3-Phase Energy Meters cover all project requirements by its energy monitoring and billing application features in commercial and residential buildings, malls, data centers. Time saving by easy allocation and billing with ES3 Series Energy Meters in mass housing projects. ES3 Series offer measuring and monitoring electrical parameters such as current, voltage, power and maximum demand in industrial facilities.

In all usage areas, an effective energy management is provided by ENTES EnerMedic Software through various communication protocols (Modbus, Ethernet).

### Specifications

- 3 Phase 4 Quadrant Energy Measurement
- Terminal Cover Opening Record
- Log Reading
- 8 Tariff Measurement
- Pulse Counter
- MID Compatible
- Bidirectional Measuring
- Class 1 Accuracy For Active Energy
- Class 2 Accuracy For Reactive Energy
- Real Time Clock
- IP54 (Front Panel)
- 2 Digital Inputs / 2 Digital Outputs



### Product Comparison Chart

Product Name	Direct current measurement	Dimensions	Segment LCD (7+1)	8 Tariff	Bidirectional measurement	Pulse Counter	Log record	MID Compatibility	MODBUS RS-485	Ethernet
ES3-63LS	63A	DIN4	●	●	●	●	●		●	
ES3-80LS	80A	DIN4	●	●	●	●	●		●	
ES3-63LSE	63A	DIN4	●	●	●	●	●			●
ES3-80LSE	80A	DIN4	●	●	●	●	●			●
ES3-63LS-MID	63A	DIN4	●	●	●	●	●	●	●	
ES3-80LS-MID	80A	DIN4	●	●	●	●	●	●	●	
ES3-63LSE-MID	63A	DIN4	●	●	●	●	●	●		●
ES3-80LSE-MID	80A	DIN4	●	●	●	●	●	●		●

## EMR Series Network Analyzers

ECONOMIC, ELEGANT AND RELIABLE

### Thinnest Design

Only 45mm Depth

### Ghost Display

For clearer and more understandable displays

### Powerful User Experience

Renewed, modest, functional menu structure and new four-button design



### High Measuring Accuracy & Detailed Harmonic

Measurement up to 31st Harmonic  
High Measurement Accuracy  
(Current, Voltage, Energy and Power Measurement Class 1)

### IoT Compatible

Instant monitoring and remote configuration via ENTES.NET  
Log Record (2MB internal memory)

### Effective Alarm Management

Flexible alarm configuration and alarm contact outputs



# Measurement

ENTES Measurement group products measure electrical parameters and provide the necessary analyzes for the efficient use of energy.

Multimeters, Ammeters, Voltmeters, Cos $\phi$  Meters, Frequency Meters, Transducers and DC Ammeter / Voltmeter in this product group offer solutions with a wide measurement range and support different types of applications.

With the optional communication feature in the measuring group devices, all measured data can be monitored from a single center.

## Multimeters

- EMM Series
- EPM-04 Series
- EPM-06 Series
- EVM-05 Series

## Ammeters

- EPM-4 Series
- EPM-R4 Series

## Voltmeters

- EVM Series

## Cos $\phi$ Meters

- ECR-3 Series

## Frequency Meter

- EFC-3 Series

## Transdüserler

- TA Series
- TV Series

## DC Ammeter

- DCA Series

## DC Voltmeter

- DCV Series

# ENTES

Meet the flexibility of remote monitoring with ENTES 3 phase Energy Meters.

## ES3 Series



3 phase 4 Quadrant  
Energy Measurement

MID compatibility

Terminal cover opening  
and Log reading

Remote Monitoring

8 Tariff Measurement

Pulse Counter



# EMM Series Multimeters

- The Thinnest Multimeter
- Powerful User Experience
- A First “Ghost Screen” Technology in the Industry
- High Measurement Precision

The thinnest multimeter  
in the world  
Only 45mm depth

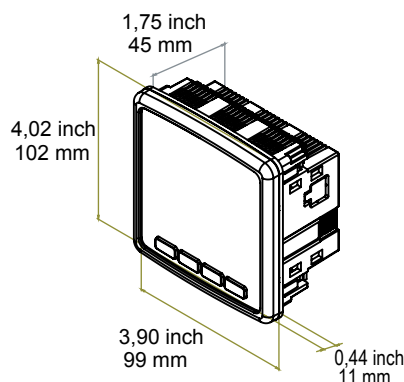

## Benefit

New ENTES EMM Series Multimeters became the most preferred choice by its ghost display technology, superior measurement capabilities and unique 45mm slim design.



## Application

Projects require electrical measurement such as current, voltage, frequency and cosφ

## Multimeters



### Product Comparison Chart

Product Name	3 ~ Voltage	3 ~ Current	Cosp	Frequency (Hz)	I Neutral	Demand	Max. Values	Contact Output	Under / Over Voltage Protection	Phase Sequence Protection	RS-485 Communication	X1/X5 Current Transformer	Operating/Total Operating Hour
EMM-04	●	●	●	●	●	●	●					●	●
EMM-04S	●	●	●	●	●	●	●				●	●	●
EMM-04C	●	●	●	●	●	●	●	●	●	●		●	●
EMM-04CS	●	●	●	●	●	●	●	●	●	●	●	●	●



### Measured Parameters

<b>EMM-04</b> <b>EMM-04S</b> <b>EMM-04C</b> <b>EMM-04CS</b>	Phase-Neural Voltages ( $V_{LN}$ )	Phase Currents (I)	Current Transformer Type Selection X1,X5
	Phase-Phase Voltages ( $V_{LL}$ )	Maximum Demand	
	Frequency (Hz)	Neutral Current	Max./Min. Values
	Cosp	RS485 Communication	



More than 600,000 ENTES Multimeters are at your service in 140 countries wherever a measurement is required from building to industrial projects.



**EPM-04**  
**EPM-06**  
**EVM-05**

In periodic maintenance applications, it can be reset with a password. While providing ease of use with "Operating Hour", you can follow the operating times of your non-resetable "Total Operating Hour" equipment. (EPM-04h)

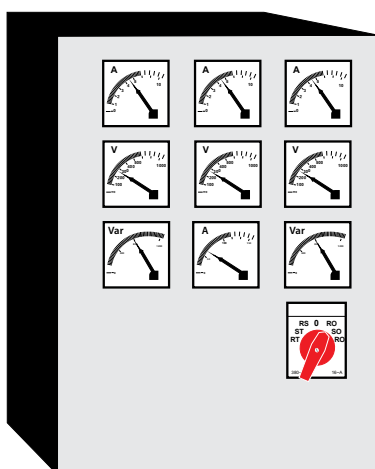

Measurements that using more than one analog measuring tools can be done with a single multimeter.





## Multimeters



### Product Comparison Chart

Product Name	3 ~ Voltage	3 ~ Current	Cosp	Frequency (Hz)	I Neutral	Demand	Max. Values	Min. Values	Output Contact	Under/Over Voltage Protection	Under/Over Current Protection	Under/Over Frequency Protection	Phase Line Protection	RS-485 Communication Interface	X/1, X/5 Current Tr.	CT-25 (120A) Akim Tr.	Operating Hour (Resetable)	Total Operating Hour(Cannot Deleble)	Panel Type	Rail Type
<b>Panel Mounting</b>																				
EPM-04-96	●	●		●	●	●	●	●							●	○			●	
EPM-04h-96	●	●		●	●	●	●	●							●	○	●	●	●	
EPM-04C-96	●	●		●	●	●	●	●	●	●	●	●	●		●	○			●	
EPM-04CS-96	●	●		●	●	●	●	●	●	●	●	●	●	●	●	○			●	
EPM-06-96	●	●	●	●	●	●	●	●							●				●	
EPM-06C-96	●	●	●	●	●	●	●	●	●	●	●	●	●		●				●	
EPM-06CS-96	●	●	●	●	●	●	●	●	●	●	●	●	●	●	●				●	
EVM-05C-96	●			●			●	●	●	●		●	●							●
<b>Rail Mounting</b>																				
EPM-04-DIN	●	●		●	●	●	●	●							●					●
EPM-04C-DIN	●	●		●	●	●	●	●	●	●	●	●	●		●	○				●
EPM-04CS-DIN	●	●		●	●	●	●	●	●	●	●	●	●	●	●					●
EPM-06-DIN	●	●	●	●	●	●	●	●							●					●
EPM-06C-DIN	●	●	●	●	●	●	●	●	●	●	●	●	●		●	○				●
EPM-06CS-DIN	●	●	●	●	●	●	●	●	●	●	●	●	●	●	●	○				●
EVM-05C-DIN	●			●			●	●	●	●		●	●							●

○ Optional



### Measured Parameters

<b>EPM-04</b>	Phase-Neural Voltages ( $V_{LN}$ )	Phase Currents (I)	
<b>EPM-04C</b>	Phase-Phase Voltages ( $V_{LL}$ )	Maksimum Demand	
<b>EPM-04CS</b>	Frequency (Hz)	Neutral Current	Max./Min. Values
<b>EPM-06</b>	Cosp		
<b>EPM-06C</b>			
<b>EPM-06S</b>			



“

ENTES Multimeter product family provides solutions for your electrical measurement requirements and suitable for all types of applications.

”

Ampermetreler



# EPM-4 Series EPM-R Series

- True RMS Measurement
- Adjustable Current Transformer Primary Value (1...1000/5A, 1...5000/1A for EPM 34/14)
- Double Isolation(□), Measuring Category III Panel or Rail Mounting
- Operating Temperature: -50C,+500C, -50C,+700C for EPM-14/34



## Benefit

ENTES Ammeters measure current values required for the electrical parameter analysis and contribute efficient use of energy.



## Application

ENTES Ammeters are designed for electrical projects require a measurement of current values.

## Ammeters



### Product Comparison Chart

Product Name		3 ~ Current	1 ~ Current	CT-25 (210A)	Double Demand*	X/1 CT	X/5 CT	Demand	Output Contac	Panel Type	Rail Type	Constant Current Terminals	24-250V AC/DC
EPM-4A-72	With Direct Ammeter CT-25 (210A) (CT-25 included)		●	●			●	●		●			
EPM-4A-96	With Direct Ammeter CT-25 (210A) (CT-25 included)		●	●			●	●		●			
EPM-4C-48	Ammeter (Contact Output) (CT-25 not included)		●	●			●	●	●	●			
EPM-4C-72	Ammeter (Contact Output) (CT-25 not included)		●	●			●	●	●	●			
EPM-4C-96	Ammeter (Contact Output) (CT-25 not included)		●	●			●	●	●	●			
EPM-4C-OG-96	Ammeter Contact Output (for MV application)		●				●	●	●	●		●	
EPM-4D-48	Ammeter		●				●	●		●			
EPM-4D-72	Ammeter		●				●	●		●			
EPM-4D-96	Ammeter		●				●	●		●			
EPM-4P-96	Ammeter (CT-25 not included)		●	●			●	●	●	●			
EPM-R4C-CT25	(CT-25 not included)		●	●			●	●	●		●	●	
EPM-14-96	Ammeter		●		●	●	●			●		●	●
EPM-34-96	Ammeter	●			●	●	●			●		●	●

#### CURRENT TRANSFORMER (For ENTES Measuring Instruments)

CT-25 Conversion Ratio: 1/2500, Inner Diameter: 15.5 mm, Outer Diameter: 43 mm



CT-25 is a cost effective solution for low current systems' metering panels.

See page 108.



“

With over 40 years of experience, ENTES develops accurate and reliable solutions contributing improved energy efficiency.

”

Voltmeters

# EVM Series



24 ~ 250 VAC/DC (for EVM-35/15)  
 Measuring Range with Transformer 1-40 kV  
 (for EVM-35/15)  
 Measurement Class 0.5 (for EVM-35/15)  
 IP54 (for EVM-35/15)

True RMS Measurement  
 Double Isolation (□)  
 Measurement Category III  
 Operating Temperature : -5°C / +50°C,  
 -5°C,+70°C (EVM-15/35)

## Product Comparison Chart

Product Name			Selectable 3-Phase	3~ Voltage	1~ Voltage	Max. Value	Min. Value	Output Contact	24-250V AC/DC	Front Panel Mounting
EVM-3-48	Voltmeter				●	●	●			●
EVM-3-72	Voltmeter				●	●	●			●
EVM-3-96	Voltmeter				●	●	●			●
EVM-3C-48	Voltmeter (Contact Output)				●	●	●	●		●
EVM-3C-72	Voltmeter (Contact Output)				●	●	●	●		●
EVM-3C-96	Voltmeter (Contact Output)				●	●	●	●		●
EVM-3S-48	3-Phase Selectable Voltmeter		●							●
EVM-3S-72	3-Phase Selectable Voltmeter		●							●
EVM-3S-96	3-Phase Selectable Voltmeter		●							●
EVM-15-96	Voltmeters(Class0.5)				●				●	●
EVM-3S-96	3-Phase Selectable Voltmeter(Class0.5)			●					●	●



### Benefit

ENTES Voltmeters measure voltage values in various applications enable necessary analysis for the efficient use of energy.

### Application

ENTES Voltmeters are designed to measure accurate and reliable voltage value of electrical systems for both industrial and residential projects

## Frequencymeters/Cosφmeter



## ECR Series

### ECR-3

The Cosφmeter measures the Cosφ of the energy drawn from the networks. It also shows whether the operating load is inductive or capacitive.



## EFC Series

### EFC-3

Frequencymeter precisely measures the frequency of operating voltage in industrial facilities.

- Double Insulation (□)
- Measurement Category III
- IP40 (Front Panel)



## Product Comparison Chart

Product Name	
ECR-3-48	Cosφmeter (0 - 1,00 ind., cap.)
ECR-3-72	Cosφmetre (0 - 1,00 ind., cap.)
ECR-3-96	Cosφmetre (0 - 1,00 ind., cap.)
EFC-3-48	Frequencymeter (20-400 Hz.)
EFC-3-72	Frequencymeter (20-400 Hz.)
EFC-3-96	Frequencymeter (20-400 Hz.)

## Current Transducers



## TA Series

Transducers convert electrical signals coming to their inputs into analog signals. They are used in automation systems.

TA-111, TA-112 Current Transducers are input powered. Also, the supply voltage is not applied. Output signal is 0-20mA. The transformer used in the input circuit of TA-111, TA-112 Current Transducers provides galvanic isolation between the input signal and the output signal.



## Product Comparison Chart

Product Name	
TA-111	Input : 0-1A AC, Output : 0-20mA DC
TA-112	Input: 0-5A AC, Output: 0-20mA DC

Specifications	TA-111	TA-112
<b>Enclosure</b>		
Dimensions	DIN III Type PK 20	
Protection Class	Double insulation IP40 front panel	
Weight	0.3kg/pc	
<b>MEASUREMENT</b>		
Current	0-1A	0-5A
Overload Capacity	1,5xIn (continuous) 20xIn(1 sec) In=1A	1,5xIn (continuous) 20xIn(1 sec) In=5A
Power Consumption	<3VA	
Output Signal	0-20mA DC	
Linear Output Range	(0,05...1,1)xIn	
Load	0-750 ohm	
Accuracy	<%0.5 (Full scale)	
Output Response Time	<300 ms	
Frequency	50 Hz	
<b>AMBIENT CONDITIONS</b>		
Operating Temperature	-5 / +50°C	
Ambient Humidity	<%75	
<b>CONNECTIONS</b>		
Mounting	Rail Mounting	
Connection Terminals	Screw Type	

## Voltage Transducers



# TV Series

Transducers convert electrical signals coming to their inputs into analog signals.

TV-111 Voltage Transducer is input powered. Also, the supply voltage is not applied. Output signal is 0-20mA. The transformer used in the input circuit of the TV-111 voltage transducer provides galvanic isolation between the input and output signals.



## Product Comparison Chart

Product Name	
TV-111	0-220 VAC, Output : 0-20mA DC

Specifications	TV-111
<b>Enclosure</b>	
Dimensions	DIN III PK 20, 20 Pieces / Box
Protection Class	Double insulation IP40 front panel
Weight	0.25kg/pc
<b>MEASUREMENT</b>	
Current	0-220 VAC
Overload Capacity	1,2xUn (continuous) 2xUn(1 sec)Un=220V AC
Power Consumption	<4VA
Output Signal	0-20mA
Linear Output Range	(0,5...1,2)xUn
Load	0-750 Ω
Accuracy	<0.5% (Full scale)
Output Response Time	<300 ms
Frequency	50 Hz
<b>AMBIENT CONDITIONS</b>	
Operating Temperature	-5 / +50°C
Ambient Humidity	<%75
<b>CONNECTIONS</b>	
Mounting	Rail Mounting
Connection Terminals	Screw Type

DC Ammeters / Shunts

# DCA Series



DCA Series is the ideal solution for measuring the base current values of your system.

- The current is measured via an externally connected shunt resistor.
- Wide supply voltage range, 85-265 VAC/DC (DCA-10), 10-56 VAC/DC (DCV-11)
- Communication with MODBUS RTU protocol over RS-485 line
- With 2 Programmable Alarm Relays, the range in which the current value in the system is desired to be determined can be determined and a warning signal can be provided with Alarm1 (C1) and Alarm2 (C2) contact outputs when the current goes out of this value. (DCA-10C/10CS/11C/11CS)
- Recording the measured maximum-minimum values
- Easy access to settings with backlit LCD screen
- Demand measurement period adjustable in the range of 1-600 sec



See page 63 for energy monitoring software.



## Product Comparison Chart

Product Name	Current	Max. Value	Min. Value	Class0.5	Measuring Range+/-10kA DC	2 Output Contacts	RS-485 Modbus	Pano Tipi	10-56 VDC	85-265 VAC/DC
DCA-10	●	●	●	●	●			●		●
DCA-10C	●	●	●	●	●	●		●		●
DCA-10S	●	●	●	●	●		●	●		●
DCA-10CS	●	●	●	●	●	●	●	●		●
DCA-11	●	●	●	●	●			●	●	
DCA-11C	●	●	●	●	●	●		●	●	
DCA-11S	●	●	●	●	●		●	●	●	
DCA-11CS	●	●	●	●	●	●	●	●	●	



## DC Ammeters / Shunts

### DC Shunts

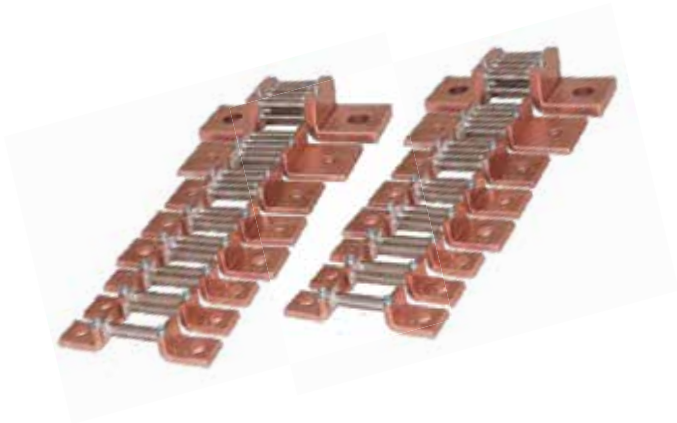

In applications where DC current measurement is required, a shunt with appropriate current values is selected and connected to the cable in series.

### Product Comparison Chart

Product Name		A (mm)	B (mm)	C (mm)	D (mm)	E (mm)	Fixing Bolt	Weight
SA60-30	30A, 60mV shunt	12,5	3	100,28	15	45,25	M5	29,4
SA60-40	40A, 60mV shunt	12,5	3	88,9	15	33,9	M5	28,2
SA60-50	50A, 60mV shunt	12,5	3	90	15	35	M5	29,5
SA60-60	60A, 60mV shunt	12,5	3	91,5	15	36,5	M5	30,6
SA60-100	100A, 60mV shunt	12,5	5	105,4	20	39,4	M8	77
SA60-150	150A, 60mV shunt	17,5	5	104	20	38	M8	81,3
SA60-250	250A, 60mV shunt	17,5	5	120,5	30	38,5	M10	141,8
SA60-500	500A, 60mV shunt	20	5	137,4	50	39,4	M10	293,8
SA60-1000	1000A, 60mV shunt	34	10	153,4	50	39,4	M16	738



“ ENTES DC Ammeter Series is designed for current measurement in DC systems. Range provides ease of assembly with its small dimensions. In solar systems, ammeters measure critical values such as panel output currents, battery charging current. Measured values can be recorded and remotely monitored with communication feature.



DC Voltmeters

# DVC Series



DCV Series is an ideal solution for measuring the base voltage values of your system.

- The device is designed to measure the voltage of a DC system.
- Wide supply range, 85-265 VAC/DC (DCV-10), 10-56 VAC/DC (DCV-11)
- Communication with MODBUS RTU protocol via RS-485
- With 2 Programmable Alarm Relays, the range in which the voltage value in the system is desired to be determined can be determined and a warning signal can be provided with Alarm1 (C1) and Alarm2 (C2) contact outputs when the voltage goes out of this value. (DCA-10C/10CS/11C/11CS)
- Saving the measured Maximum-Minimum values Easy access to the settings with the illuminated LCD screen
- Demand period adjustable in the range of 1-600 sec.



## Product Comparison Chart

Product Name	1~ Voltage	Max. Value	Min. Value	Class0.5	Measuring Range+/-10kA DC	2 Output Contacts	RS-485 Modbus	Pano Tipi	10-56VDC	85-265 VAC/DC
DCA-10	●	●	●	●	●			●		●
DCV-10C	●	●	●	●	●	●		●		●
DCV-10S	●	●	●	●	●		●	●		●
DCV-10CS	●	●	●	●	●	●	●	●		●
DCV-11	●	●	●	●	●			●	●	
DCV-11C	●	●	●	●	●	●		●	●	
DCV-11S	●	●	●	●	●		●	●	●	
DCV-11CS	●	●	●	●	●	●	●	●	●	



# Protection & Control

The ENTES Protection & Control product group consists of a wide range of products that provide solutions for the safe operation of systems and all control needs.

## Motor Phase Protection Relays

- MKS Series
- MCS Series

## Phase Sequence Protection Relays

- FR-02

## Voltage Protection Relays

- DGRC-01
- GKRC-E Series
- GKRC Series
- MCC Series

## Current Protection Relays

- AKC Series

## Over Current Secondary Protection Relays

- CKR Series

## Time Relays

- ERTC Series
- ERB Series
- MCB Series
- EF Series
- DG Series
- SSR-2X
- SER-YU

## Multifunctional Timer Relays

- MCB-100/200
- ERTC-100 Series

## Astronomical Time Relays

- DTR Series
- MCB-50 Series

## Programmable Time Clocks

- MCB-50/50T
- MCB-A

## Liquid Level Control Relay

- SSRC Series

## Photocell Relays

- FG Series

## Power Supplies

- PS Series

## Control-Insulation Transformers

- ENT.PST/ENT.IST Series

# ENTES

Reliable protection to your equipment with ENTES Voltage Protection Relay with Display...



## GKRC-E Series

Over Voltage and Low Voltage Protection

Voltage Imbalance Protection

Over Frequency Protection

Low Frequency Protection

Phase Sequence Protection

Phase Failure Protection

## Motor Phase Protection Relays



## MKC - MKS Series

MKS-MKC Motor Protection Relays are designed to prevent 3-phase motors from overheating and being damaged due to phase failure or imbalance in industrial facilities.

1. Lack of Phase
2. Phase Sequence Error
3. PTC Protection
4. Fixed Asymmetry (Voltage Imbalance)
5. Adjustable Asymmetry (Voltage Unbalance)

Reliable protection  
experience combined with  
quality  
by ENTES MKC/MKS Series...



### Benefit

MK Series Motor Protection Relays protect your equipment and systems against phase breaks and unbalances.



### Usage Areas

They are preferred by all businesses that want to protect their equipment against costly failures with features such as neutral break, absence of phase, phase sequence and PTC protection.

# Motor (Phase) Protection Relays



## Product Comparison Chart

Product Name		Neutral Break Detection	Lack of Phase	Phase Sequence Error	PTC Protection	Constant Asymmetry	Adjustable Asymmetry	Without neutral	Adjustable OFF Delay	Adjustable ON Delay	1 C/O Contact	1 N/O Contact	220-230 VAC	380-400 VAC	160-690 VAC	DIN1 Rail Mount	DIN2 Rail Mount
MK-01	Motor (Phase) Protection Relays	●	●			%20					●	●					
MKC-01	Motor (Phase) Protection Relays	●	●			%20					●	●					●
MKS-01	Motor (Phase) Protection Relays	●	●			%20						●	●				●
MKC-03	Motor (Phase) Protection Relays	●	●	●		%40					●	●					●
MKC-03P	Motor (Phase) Protection Relays (With PTC3)	●	●	●	●	%40					●	●					●
MKS-03	Motor (Phase) Protection Relays	●	●	●		%40						●	●				●
MKC-04	Motor (Phase) Protection Relays		●	●		%40		●			●	○	●				●
MKC-04-U69	Motor (Phase) Protection Relays		●	●		%10		●			●				●		●
MKC-05	Motor (Phase) Protection Relays	●	●	●		%5-15 ; OFF		●	●	●	●	●					●
MKC-05P	Motor (Phase) Protection Relays (With PTC3)	●	●	●	●	%5-15 ; OFF		●	●	●	●	●					●
MKC-06	Motor (Phase) Protection Relays		●	●		%5-15 ; OFF		●	●	●	●			●			●
MKC-06P	Motor (Phase) Protection Relays (With PTC3)		●	●	●	%5-15 ; OFF		●	●	●	●			●			●
MKC-30	Motor (Phase) Protection Relays	●	●	●		%5-25 ; OFF				●	●	●					●

○ Optional

### Protection Features

#### 1. Absence of Phase

If there is voltage in the 3 phases monitored; output relay is in ON position. In case of failure of any of the 3 phases, the output relay automatically switches to OFF.

#### 2. Phase Sequence Failure

When the phase sequence is correct (clockwise L1, L2, L3), the output relay is in the ON position; however, if the sequence changes, the output relay automatically switches to OFF.

#### 3. PTC Protection

If the winding temperatures in the motors exceed the PTC limit temperature value, the output relay automatically switches to OFF.

#### 4. Constant Asymmetry (Voltage Unbalance)

If the Phase-Neutral voltage shows voltage unbalance over a certain constant value (over 20% or 40%), the output relay switches to OFF in 0.2 seconds.

#### 5. Adjustable Asymmetry (Voltage Unbalance)

If the Phase-Phase (MKC-06/06P) or Phase-Neutral (MKC-05/05P) voltage unbalance is lower than the value set by the user, the output relay switches ON. If the unbalance value exceeds the limit value set by the user (5% - 15%), the output relay switches to OFF after the delay time (0.1... 20s) defined by the user. If the fault disappears within the delay time, the output relay will not turn OFF and the motor will continue to run normally. In addition to these features, if the L3 phase falls below 50% of the operating voltage of the device (MKC-05/05P), the relay switches to OFF without delay. In this case, the phase sequence and asymmetry LEDs start to flash.

## Phase Sequence Relay / Thermistor Relay

# FR-02 / PT-01



### FR-02

The FR-02 Phase Sequence Relay controls the sequence of the 3 phases feeding the motors. If the R, S and T phases are in the correct order, the OUT LED on the front panel lights up. If the phase sequence is wrong, the OUT (output) LED turns off and the output relay automatically turns OFF.

### PT-01

The PT-01 Thermistor Relay has been developed for the protection of motors with PTC. If the winding temperatures in the motors exceed the PTC limit temperature value, the output relay automatically switches to OFF. Please refer to the graphic below to see the heat characteristics of the PTC at 3 different shutdown temperatures (110 °C, 120 °C, 130 °C).



## Product Comparison Chart

Product Name		Neutral Fault Detection	Lack of Phase	Phase Sequence Error	PTC Protection	1 C/O Contact	DIN2 Rail Mount
FR-02	Phase Sequence Protection Relay	●	●	●		●	●
PT-01	Thermistor Relay				●	●	●
PTC-3	Triple Thermistor Group (Auxiliary Circuit Element)						

Features	
Operating Voltage	230 VAC
Operating Frequency	50/60 Hz
Operating Range	(0,9-1,1) x Un
Connection	3-phase / neutral (FR-02) / 1-phase / neutral (PT-01)
Contact Output	1 CO contact, 8A, 2000 VA (FR-02) 5A, 1250 VA (PT-01)
Protection Class	IP20
Ambient Temperature Range	-5 / +55°C
Dimension	36x90x60 mm (FR-02, PT-01)
Mounting	Rail Mounting; Screw Terminal Block
Weight	0.15 kg/pc (FR-02) 0.2 kg/pc (PT-01)

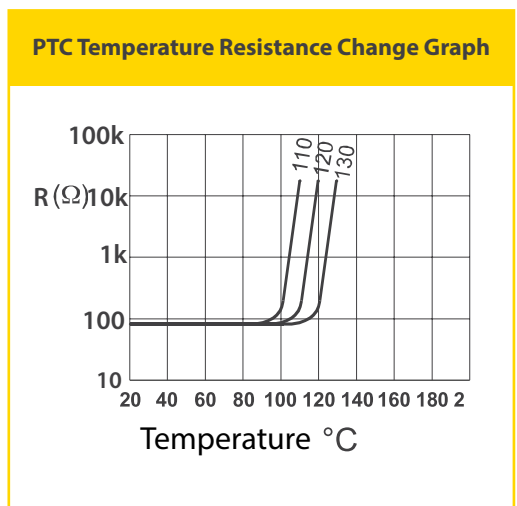

Voltage Protection Relays

# GKRC / DGRC / MCC Series



### GKRC Series

GKRC Series Voltage Protection Relays are designed to protect single or three phase systems from sudden voltage changes and phase sequence disturbances.

When the nominal voltage of any phase increases or decreases by 50%, the relay switches to OFF without delay.

### DGRC Series

DGRC Series Voltage Protection Relays are designed to protect single or three phase systems in permanent undervoltage.



## Product Comparison Chart

Product Name		LCD Display	Neutral Break Detection	3-Phase	Single-Phase	Undervoltage	Overvoltage	Under Frequency	Over Frequency	Voltage Unbalance	Phase Failure Protection	Phase Sequence Protection	ON Delay	OFF Delay	TURN-OFF Delay	Without-Neutral	Auxiliary Supply	230 VAC	400 VAC	85-300VAC	150-500VAC	Relay	DIN1 Rail Mounting	DIN2 Rail Mounting	
GKRC-31E LCD		●		●		●	●	●	●	●	●	●	●	●		●					●	1		●	
GKRC-21E LCD		●	●	●		●	●	●	●	●	●	●	●	●							●	1		●	
GKRC-32E LCD		●		●		●	●	●	●	●	●	●	●	●		●						●	2		●
GKRC-22E LCD		●	●	●		●	●	●	●	●	●	●	●	●							●	2		●	
DGRC-01			●	●		■							●		●			●						●	
GKRC-01			●	●			■						●		●			●						●	
GKRC-02			●	●		■	■						●		●			●						●	
GKRC-02F			●	●		■	■				●	●	●		●			●						●	
GKRC-02FA				●		■	■				●	●	●		●	●	●	●						●	
GKRC-03				●		■	■						●		●	●				●				●	
GKRC-03F				●		■	■				●	●	●		●	●				●				●	
GKRC-M2			●		●	■	■						●		●			●						●	
MCC-1D	5-15 min. ON Delay		●		●	■					●		●					●						●	
MCC-3D	5-15 min. ON Delay		●	●		■					●		●					●						●	
GKRC-30F			●	●		○	○				●	○			●			●						●	

■ Adjustable and Closeable.  
○ Selectable



## Current Protection Relays



# AKC Series

AKC Series Current Protection relays measure the current of the systems and shut down the systems when the measured current values are above or below the adjusted level.



### Product Comparison Chart

Product Name		Low Current Protection	Over Current Protection	../5A	CT-25 Included	230 VAC	DIN2 Rail Mount
AKC-01D	Low Current Protection (0.5-5A)	●		●		●	●
AKC-01A	Over Current Protection (0.5-5A)		●	●		●	●
AKC-03D	Low Current Protection (with CT-25 between 1.5A and 60A)	●			●	●	●
AKC-03A	Over Current Protection (with CT-25 between 1.5A and 60A)		●		●	●	●

Experience reliable protection with **ENTES AKC Series**, which combines innovation and superior quality...



### Benefit

ENTES AKC Series Current protection Relays are designed to protect systems against to current imbalances.



### Application

ENTES AKC Series is a reliable solution for all facilities require an equipment protection within a certain current range.

## Over Current Secondary Protection Relays

# CKR Series



CKR Series Overcurrent Relays combine reverse and independent time relays in a single device. CKR Series Overcurrent Relays are used to protect transformers, motors, generators and power transmission lines in the power distribution system against short circuits and ground failures. "Selective protection" should be applied to ensure the highest level of protection. The main purpose of the selective protection is to limit the fault to the minimum and disconnect as soon as possible.



### Product Comparison Chart

Product Name	
CKR-93T	3 Phase + 1 Ground (Adjustable inverse and fixed time, for phase and ground) 85-265 VAC / DC
CKR-92T	2 Phase + 1 Ground (Adjustable inverse and fixed time, for phase and ground) 85-265 VAC / DC; 24 VDC

Correct protection for inverse time overcurrent relays can be realized under the following conditions:

- 1) Relays with the same operating characteristics should be connected in series with each other.
- 2) TURN-OFF Delay of the relays used in the system should be set as "Current/time steps". The current dependent TURN-OFF Delay time of the relays should be designed in such a way that the "current/time steps" decrease with distance from the source. In this way, the relay at the end of the line (R4 as follows) should have the shortest TURN-OFF time. This can be seen from the diagrams and the current-time characteristics given below:

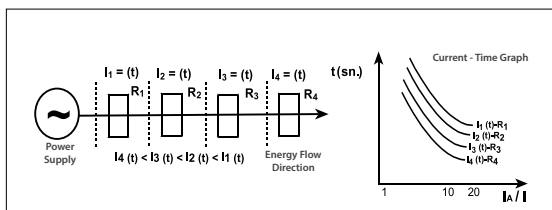

- Double Isolation (□)
- Measurement Category III
- Terminal Connection
- Flush Mounting
- IP40 (front panel)
- IEC 60255-3
- IEC 60255-6
- IEC 529

A. The CKR series has the following I/t characteristics. According to EC-255, BS-142 these are:

- a - Normal Inverse
- b - Very Inverse
- c - Extreme Inverse
- d - Long Time Inverse (CKR-93T)
- e - Independent Time 1 (2.5 sec.)
- f - Independent Time 2 (5 sec.)
- g - Independent Time 3 (10 sec.)
- h - Independent Time 4 (15 sec.)

The instantaneous TURN-OFF current, time multiplier and current time characteristic settings can be selected separately for phase and neutral.

Time Relays



# MCB / SER /ERTC / SSR / DG Series

Product Comparison Chart

Product Model	Product Description	Time	ON Delay	OFF Delay	ON Flasher	OFF Flasher	Down Counter	Star - Delta	Right - Left	Power OFF Delay	OFF Delay with Control Output	ON Delay with Control Output	Symmetrical Flasher	Single Shot Leading Edge with Control Input	Single Shot Trailing Edge with Control Input	Pulse	Yükselen Kenarda Çakımda Dışarı Kenarda Bırakımda Geçikmeli	Yükselen ve Düşen Kenarda Tetiklemeli Bırakımda Geçikmeli	With Trigger	24VAC / DC	230 VAC	12-240 VAC / DC	24-240 VAC / DC	DIN I	DIN II	DIN III
			ON Delay	OFF Delay	ON Flasher	OFF Flasher	Down Counter	Star - Delta	Right - Left	Power OFF Delay	OFF Delay with Control Output	ON Delay with Control Output	Symmetrical Flasher	Single Shot Leading Edge with Control Input	Single Shot Trailing Edge with Control Input	Pulse	Yükselen Kenarda Çakımda Dışarı Kenarda Bırakımda Geçikmeli	Yükselen ve Düşen Kenarda Tetiklemeli Bırakımda Geçikmeli	With Trigger	24VAC / DC	230 VAC	12-240 VAC / DC	24-240 VAC / DC	DIN I	DIN II	DIN III
<b>ERTC-01-DIN</b>	Multi-Functional Time Relay	1sn - 100 hour	●	●	●	●	●												●	●					●	
<b>MCB-30</b>	Time Relay	2-30sec	●																				●	●		
<b>MCB-60</b>	Time Relay	4-60sec	●																				●	●		
<b>MCB-7</b>	Time Relay	0,1sn - 30 hour	●	●																			●	●		
<b>MCB-8</b>	Time Relay(Fine Adjustment)	0,1sn - 999 min.	●	●																			●	●		
<b>MCB-9</b>	Multi-Functional Time Relay	0,5sn - 30 hour	●	●	●	●																●		●		
<b>MCB-15</b>	Multi-Functional Time Relay	0,1sn-100 hour	●	●						●		●							●				●	●		
<b>MCB-20</b>	Multi-Functional Time Relay	0,1sn-100 hour	●	●						●	●	●	●	●					●			●				
<b>MCB-24</b>	Multi-Functional Time Relay	0,1sn-100 hour	●	●						●	●	●	●	●					●			●				
<b>MCB-25</b>	LCD Multi-Functional Time Relay	0,1sn- 999 hour	●	●	●	●				●		●	●			●	●	●	●				●	●		
<b>EF-10</b>	Flasher Relay	1-10sn / 0,5sn		●																	●	●		●		
<b>SER-YU</b>	Star - Delta Relay	Y:1-60sn / Y→Δ:20-500ms						●												●	●				●	
<b>SSR-2X</b>	Right - Left Relay	0.1sn - 60 hour							●													●		●		
<b>DG-10</b>	Delayed in Drop	0,6 sn - 10dk								●												●			●	
<b>DG-60</b>	Dishwasher Relay	1 sn - 60dk								●												●			●	
<b>ERB-50</b>	Dishwasher Relay (With Buzzer)	Washing Time (Stable): 30sec, 60sec, 90sec, 120sec, 180sec, Waiting (Stable) : 3sec, Rinse (Adjusted) : 1-30sec																								
<b>ERB-50 BUZZER</b>	Bulaşık Makinesi Rölesi (Buzzerli)	Washing Time (Stable): 30sec, 60sec, 90sec, 120sec, 180sec, Waiting (Stable) : 3sec, Rinse (Adjusted) : 1-30sec																								

ENTES MCB Time Relays; It brings you together with reliable and flexible productivity solutions with its wide range of function alternatives.

## Functions

### OFF Delay [MCB-15 & MCB-20 & MCB-7/8/9]

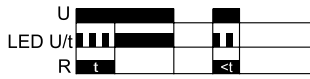

### Single Shot Leading and Trailing Edge with Control Output

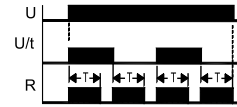

### ON Delay [MCB-15 & MCB-20 & MCB-7-8-9-30-60]

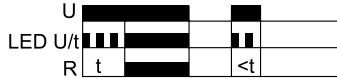

### ON Delay with Control Input Leading Edge OFF Delay with Control Input Trailing Edge

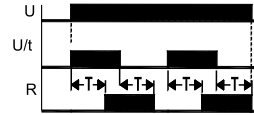

### OFF Delay with Control Input [MCB-15 & MCB-20]

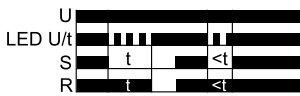

### Flasher

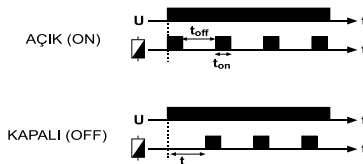

### ON Delay with Control Input [MCB-20]

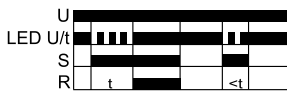

### Right-Left Operating (SSR-2X)

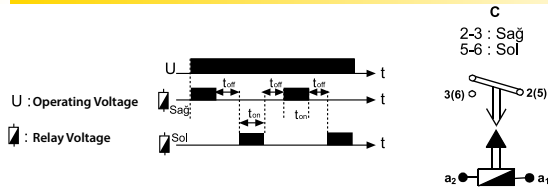

### Single Shot Leading Edge with Control Input (Ts) [MCB-20]

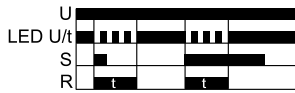

### Power OFF Delay (DG-10 / DG-60)

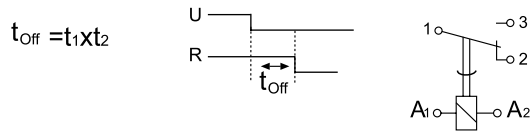

No voltage, Delay Trigger

### Single Shot Trailing Edge with Control Input (Ta) [MCB-20]

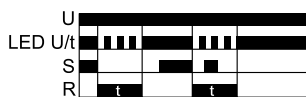

### Dishwasher Relay (ERB-50)

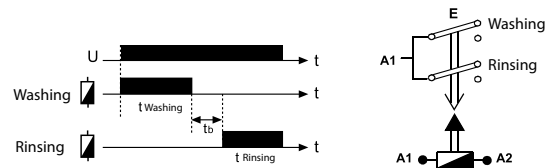

### Symmetrical Flasher [MCB-15 & MCB-20]

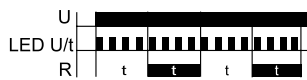

### Star-Delta Relay (SER-Y/U)

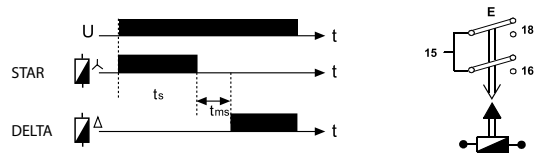

\* For SER - Y/U, 24 VAC/DC input is applied between A2-A3.

## Multifunctional Timer Relays



# MCB-100/200 ERTC-100 Series

### Multifunctional Digital Time Relays

- Ability to work with internal battery without the need for power supply (MCB-200)
- 1.000.000 contact turn/off abilities (MCB-200)
- Easy installation with user-friendly menu
- In addition to the main functions, flexible solutions suitable for the purpose in applications with sub-functions that can be controlled by triggering.
- With the memory feature, the ability to save time and status information in memory when the power supply is interrupted in some functions and to continue from where it left off when the power is restored.
- It has the features of performing the functions according to the real time clock with the digital time setting.



## Product Comparison Chart

Product Name		Time	Triggered	ON Delay	OFF Delay	Pulse	Asymmetric Flasher	Symmetrical Flasher	Start/Stop	Counter	Right-Left	Star/Delta	2 Steps ON Delay	2 Steps OFF Delay	Memory	12-30 VAC/DC	85-315 VAC/DC	Internal Battery	DIN2 Rail Mount	
MCB-100	7 Functional Time Relay	0,1sn-9999min.	●								●	●	●	●	*	●			●	
MCB-101	7 Functional Time Relay	0,1sn-9999min.	●								●	●	●	●	*	●			●	
MCB-120	17 Functional Time Relay	0,1sn-9999min.	●	●	●	●	●	●	●						*	●			●	
MCB-121	17 Functional Time Relay	0,1sn-9999min.	●	●	●	●	●	●							*	●			●	
MCB-125	21 Functional Time Relay	0,1sn-9999min.	●	●	●	●	●	●	●	●					*	●			●	
MCB-126	21 Functional Time Relay	0,1sn-9999min.	●	●	●	●	●	●	●	●					*	●			●	
MCB-130	28 Functional Time Relay	0,1sn-9999min.	●	●	●	●	●	●	●	●	●	●	●	●	*	●			●	
MCB-131	28 Functional Time Relay	0,1sn-9999min.	●	●	●	●	●	●	●	●	●	●	●	●	*	●			●	
MCB-200	Multifunctional Time Relay Without Supply	0,2sn-9999sn/0,1dk-9999min.	●	○	○	○	○	○	○										●	●
ERTC-100	Sayıcı / Impulse Zaman Rölesi	0,1sn-9999min.	●			●				●					*		●		●	
ERTC-101	Sayıcı / Impulse Zaman Rölesi	0,1sn-9999dk	●		●				●						*	●			●	

○ Functions with Triggered

To see the sub-functions included in the main functions, see the function table.

\* Memory feature is not valid for all functions of the device. See the instructions for use for the details of the applicable functions.

## Main Functions

### ON Delay

a) Power Supply Start

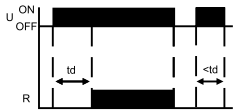

b) Control Input(\*)

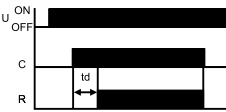

c) Resettable with Leading Edge Trigger(\*)

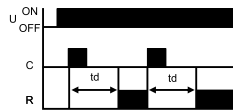

### OFF Delay

a) with Supply Voltage

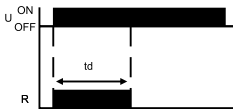

b) with Control Output(\*)

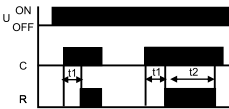

c) with Leading Edge Trigger

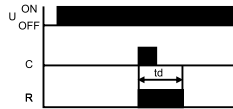

d) Resettable with Leading Edge Triggerger

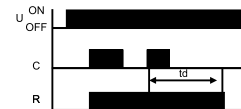

e) Resettable with Trailing Edge(\*)

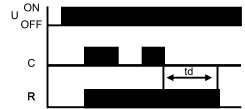

### Flasher

a) Asymmetric ON Start

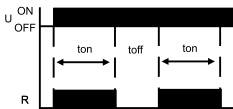

b) Asymmetric ON Start with Control Input(\*)

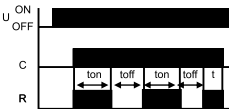

c) Resettable Asymmetric ON Start with Leading Edge Trigger(\*)

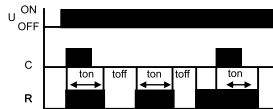

d) Asymmetric OFF Start

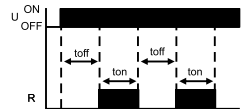

e) Asymmetric OFF Start with Control Input(\*)

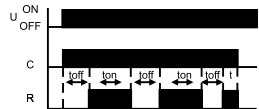

f) Resettable Asymmetric OFF Start with Leading Edge Trigger(\*)

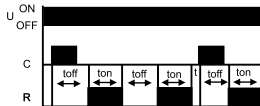

g) Symmetric ON Start with Control Input(\*)

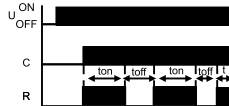

h) Symmetric OFF Start with Control Input(\*)

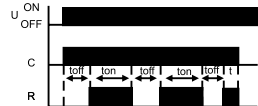

i) Resettable Symmetric OFF Start with Leading Edge Trigger(\*)

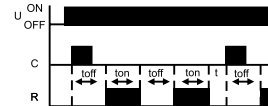

### Pulse

a) Single Pulse with ON Delay After Supply Voltage

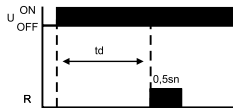

b) Adjustable OFF Delay Pulse with Leading Edge Trigger(\*)

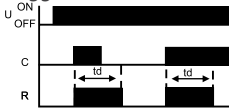

c) Resettable OFF Delay Pulse with Trailing Edge Trigger(\*)

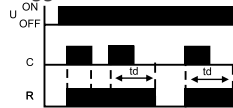

d) Adjustable OFF Delay Pulse with Leading Edge Trigger



e) Resettable Adjustable OFF Delay Pulse with Leading Edge Trigger(\*)

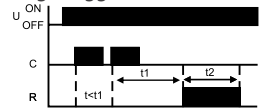

### Right-Left Switcher(with Adjustable Time)

a) ON Start

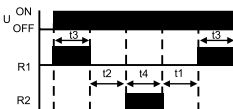

b) ON Start with Leading Edge Trigger

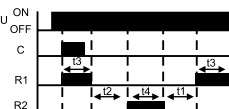

c) OFF Start with Adjustable Delay

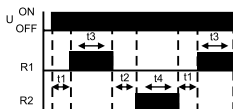

d) OFF Start with Leading Edge Trigger

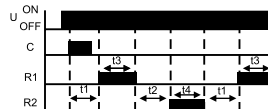

### Counter

a) Up Pulse Counter

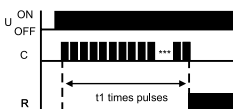

b) Up Pulse CPunter with Adjustable Pulse Output

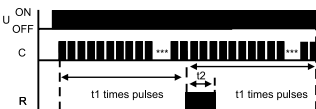

c) Down Time Counter with Leading Edge Trigger



### 2 Steps ON and OFF Delay/ Start-Stop

a) 2 Steps ON Delay



b) 2 Steps OFF Delay

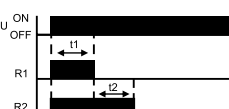

c) Start-Stop Leading Edge Trigger



\*MCB-200 contains only the functions marked with (\*) under Main Functions

## Astronomical Time Relays



## DTR Series

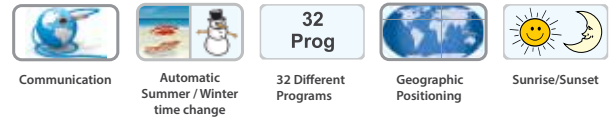

- Sunset, Sunrise Auto-Adjustment
- Automatic Switch To Summer Time
- 24/7 Programming By City Name Or Geographical Coordinate
- 15 Or 32 Program Numbers And Seconds Precision
- Modbus RS-485 Communication (DTR-20S/TS)
- Battery Level Indicator
- Display Illumination
- Password Protection
- Vacation Mode

## DTR-PROG Software

DTR-PROG Setting Software enables all settings made via DTR devices to be made easily and quickly in the computer environment. These settings are loaded into DTR-IR-PROG devices, enabling easy programming of DTRs. DTR-IR-PROG is non-contact with IR (Infrared Ray) and DTR-PROG performs the programming process by attaching to the device thanks to the PROG module.

With **ENTES DTR Series**  
uninterrupted efficiency is  
by the side of you...



### Benefit

ENTES DTR Series is designed to control your devices based on user-set time or automatically calculated sunrise/sunset



### Application

DTR Series Astronomical Time Relays provide a beneficial solution for applications such as lighting, irrigation, agricultural spraying for both commercial and residential applications.

# Astronomical Time Relays / Time Clock



## Product Comparison Chart

Product Name		Data Transfer	Changeable Battery	Ability to Program According to Prayer Times	24 hour Time Setting	Geographic Coordinate Programming (Astronomical)	15 Programs	32 Programs	1 Relay Output (16A)	2 Relay Output (16A)	85-265 VAC	190-260 VAC	DIN2 Rail Mounting
DTR-10	Astronomical Time Relay		●		●	●	●			●	●		●
DTR-10t	Astronomical Time Relay		●		●	●	●		●		●		●
DTR-20	Astronomical Time Relay, External Memory	PROG			●	●		●		●		●	●
DTR-20S	Astronomical Time Relay (Double Contact)	RS-485	●		●	●		●		●	●		●
DTR-20TS	Astronomical Time Relay (with Communication)	RS-485	●		●	●		●	●		●		●
DTR-20M	Astronomical Time Relay, IR Programming	IR			●	●		●		●		●	●
DTR-25	Astronomical Time Relay			●	●	●		●		●		●	●
<b>Programmiers</b>													
DTR-PROG	Programmer (for DTR-20)												
DTR-IR-PROG	Infrared Programmer (for DTR-20M)												

DTR-10/10t: DTR-10/10t: Astronomical Time Relay

DTR-20: DTR-20: Astronomical Time Relay (External Memory)

DTR-20M: DTR-20M: Astronomical Time Relay (IR Programming)

DTR-25: DTR-25: Astronomical Time Relay (Calculating Prayer Hours)

DTR-20S/DTR-20TS: DTR-20S/DTR-20TS: Astronomical Time Relay (Double Contact/Communication)

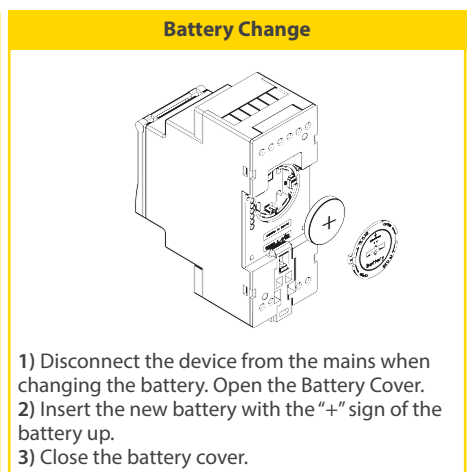
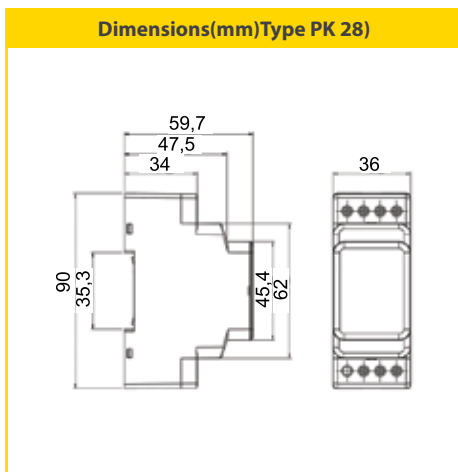
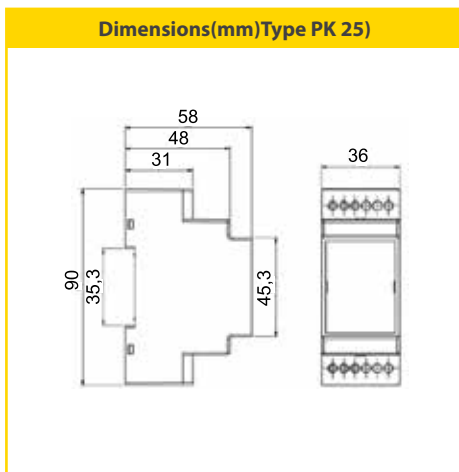



Programmable Time Clocks



# MCB-50/50T MCB-A

**MCB-50/50T:** It controls the daily and weekly operation of the devices with its user-friendly menu and 24/7 precise programming.

**MCB-A:** It controls the daily operation of electrical appliances with each ratchet gear corresponding to a time of 15 minutes.



## Product Comparison Chart

Product Model	Product Description	Daily Programming (24 hours)	Weekly Programming	Number of Programs	Minimum Switching Time	Reserve Time	1 Relay Output	2 Relay Output	230 VAC	DIN I	DIN II
<b>MCB-A</b>	Analog Time Clock	●			15 min.	100 h	●		●	●	
<b>MCB-50T</b>	Digital Time Clock	●	●	32	1 sec.	●	●		●		●
<b>MCB-50</b>	Digital Time Clock	●	●	32	1 sec.	●		●	●		●

## “Maximum comfort minimum energy with DTR series astronomic time relays!”

Interchangeable Battery

24/7 Programming by City Name and Geographical Coordinate



Password Protection

Modbus RS-45 Communication

Remote Monitoring&Control

## Liquid Level Control Relays



# SSRC Series

SSRC Series Liquid Level Control Relays are used to control liquid levels in liquid tanks in water wells and industrial facilities. Sensitivity (resistance / impedance between electrodes) can be adjusted between 5-50 kΩ or 5-100 kΩ for different liquids.



### Product Comparison Chart

Product Name		5-50 kΩ Adjustable	5-100 kΩ Adjustable	Small Electrode	Big Electrode	8 Pin Socket	230 VAC	DIN2 Rail Mounting	Socket Mounting
SSRC-04	Liquid Level Control Relay	●					●	●	
SSRC-04P	Liquid Level Control Relay (8 Pins)		●				●		●
LLS-01	Liquid Level Electrode			●					
LLS-02	Liquid Level Electrode				●				
PGS-108	SSRC-04P Socket					●			

Liquid Level Electrodes cannot be used with flammable, corrosive liquids and foodstuffs. The liquids whose level is to be controlled must have the property of conducting electricity. olması gerekmektedir.

## Socket Mounting, Innovative Liquid Level Control Solutions...



### Benefit

Liquid Level Relays in storage areas ensure the liquid level remain within the specified range to prevent any damage.



### Application

ENTES Liquid Level Control Relays are ideal for industrial and agricultural projects aim an uninterrupted continuity in production processes.

## Photocell Relays

# FG Series



FG Series Photocell Relays control the lighting systems according to the ambient light level with the lux setting on them.



### Product Comparison Chart

Product Name		1-3 Lux Adjusted	1-10 Lux Adjusted	Hand Operated	Fuse Protection	Triac Output	Relay Output	Sensor	190-260 VAC	DIN2 Box
FG-4	Photocell Relay	●					●		●	●
FG-4A	Photocell Relay		●				●		●	
FG-4R	Photocell Relay		●	●	●		●		●	
FG-4T	Photocell Relay (Triac output)		●	●	●	●			●	
FG-GÖZ	Photocell Relay							●		

With **ENTES FG Series**,  
Correct Illumination Level is  
under your control...



### Benefit

ENTES FG Series Photocell Relays are designed to activate and deactivate lighting or other systems based on required illumination level.



### Application

ENTES FG Series Photocell Relays are ideal solutions for controlling lighting or other systems in all industrial or residential applications.

Power Supplies



# PS Series

PS Series Power Supplies provide safe DC output voltage for systems with its wide supply (AC/DC voltage range) and adjustable output voltage.



## Product Comparison Chart

Product Name		Universal Input Voltage 85-265 VAC	110-350 VDC	1A Output Current	1.5A Output Current	3A Output Current	5A Output Current	Contact Output	Parallel/Serial Connection	LED Display	Adjustable Output Voltage	Under/High Voltage Supply Protection	Overload Protection	Thermal Protection	Output Short Circuit Protection	DIN 3 Rail Mounting	DIN 4 Rail Mounting
PS-242	24W-1A-24 VDC	●	●						●	●			●	●	●	●	
PS-361	36W-3A-12 VDC	●			●				●	●		●	●	●	●		●
PS-362	36W-1,5A-24 VDC	●		●			●		●	●	●	●	●	●	●		●
PS-722	72W-3A-24 VDC	●							●	●	●	●	●	●	●		●
PS-1202	120W-5A-24 VDC	●			●	●			●	●	●	●	●	●	●		

**Reliable DC Output Voltage with superior ENTES Quality...**



### Benefit

ENTES PS Series Power Supply provides reliable DC power.



### Usage Areas

ENTES PS Series are ideal for Industrial and commercial building projects require stable DC power.

## Power Supplies

### PS-242 Power Supply 24W-1A-24 VDC

- Wide Supply Voltage (85-265 VAC/ 110-350 VDC)
- 24 VDC Output Voltage
- 1A Nominal Output Current
- High Efficiency Operation with >82%
- Overload, Overheat and Output Short Circuit Protection
- Class 2 Protection Not Requiring Ground Connection

### PS-361 Power Supply 36W-3A-12 VDC

- Wide Supply Voltage(85-265VAC/ 110-350VDC)
- 12 VDC Output Voltage
- 3A Nominal Output Current
- High Efficiency Operation with >85%
- Auto-Reset feature to protect itself and the system by automatically shutting down in cases such as overload, overheating, low/high input or output voltages short circuit, automatic activation when the fault disappears
- Class 2 Protection Not Requiring Ground Connection

### PS-362 Power Supply 36W-1,5A-24 VDC

- Wide Supply Voltage(85-265VAC/ 110-350VDC)
- Ability to work in the desired voltage range with adjustable output voltage (21.6-27.6 VDC)
- 1,5A Nominal Output Current
- High Efficiency Operation with >85%
- Auto-Reset feature to protect itself and the system by automatically shutting down in cases such as overload, overheating, low/high input or output voltages short circuit, automatic activation when the fault disappears
- Remote monitoring of the power source with 1 NC contact (10A -250 VAC / 5A 30 VDC), integrating it into the automation system
- Class 2 Protection Not Requiring Ground Connection

### PS-722 Power Supply 72W-3A-24 VDC

- Wide Supply Voltage(85-265VAC/ 110-350VDC)
- Ability to work in the desired voltage range with adjustable output voltage (21.6-27.6 VDC)
- 3A Nominal Output Current
- High Efficiency Operation with >87%
- Auto-Reset feature to protect itself and the system by automatically shutting down in cases such as overload, overheating, low/high input or output voltages short circuit, automatic activation when the fault disappears
- Class 2 Protection Not Requiring Ground Connection
- In case of thermal protection, after the device cools down, the power supply must be disconnected and reconnected.

### PS-1202 Power Supply 120W-5A-24 VDC

- Wide Supply Voltage(85-265VAC/ 110-350VDC)
- Ability to work in the desired voltage range with adjustable output voltage (20.7-27.6 VDC)
- 5A Nominal Output Current
- Auto-Reset feature to protect itself and the system by automatically shutting down in cases such as overload, overheating, low/high input or output voltages short circuit, automatic activation when the fault disappears
- It occupies less space with its slip-type design in panels where mounting space is important.
- Class 2 Protection Not Requiring Ground Connection

## Function Charts

### MOTOR (PHASE) PROTECTION RELAYS

No Phase + Constant Asymmetry		MKC-01	MKS-01	
No Phase + Constant Asymmetry + Phase Sequence	MKC-03	MKS-03	MKC-04 / 04-U69	
No Phase + Constant Asymmetry + Phase Sequence + PTC	MKC-03P			
No Phase + Adjust. Asymmetry + Phase Sequence + Adjustment. ON and/or OFF Delay	MKC-05	MKC-06	MKC-30	
No Phase + Adjust. Asymmetry + Phase Sequence + Adjustment. ON and OFF Delay + PTC	MKC-05P	MKC-06P		
No Phase + Phase Sequence	FR-02			
PTC	PT-01			

### VOLTAGE PROTECTION RELAYS

Low Voltage + Adjustable ON and OFF Delay	DGRC-01			
Low Voltage + Adjustable ON Delay	MCC-1D	MCC-3D		
Overvoltage + Adjustable ON and OFF Delay	GKRC-01			
Under Voltage + Over Voltage + Adjustable. ON and OFF Delay	GKRC-02	GKRC-03	GKRC-M2	
No Phase+Undervoltage+Overvoltage+Adjustable Tripping and OFF-ON Delay+Phase Sequence	GKRC-02F	GKRC-02FA	GKRC-03F	GKRC-30F

### CURRENT PROTECTION RELAYS

Under Current	AKC-01D	AKC-03D		
Over Current	AKC-01A	AKC-03A		

### TIME RELAYS

ON Delay	MCB-30	MCB-60		
ON Delay +OFF Delay	MCB-7	MCB-8		
Open Flasher	EF-10	EF-10T		
ON Delay +OFF Delay+ON Flasher +OFF Flasher	MCB-9			
ON Delay +OFF Delay+ON Flasher +OFF Flasher+ Down Counter	ERTC-01			
ON Delay +OFF Delay+ON Delay with Control Input + OFF Delay with Control Input + Triggered	MCB-15			
ON Delay +OFF Delay+ON Delay with Control Input + OFF Delay with Control Input + Triggered+ Symmetric Flasher	MCB-20	MCB-25		
Single Shot Leading and Trailing Edge with Control Input ON Delay with Control Input Leading Edge Delay with Control Input Trailing Edge	MCB-25			
Power OFF Delay	DG-10	DG-60		
Star- Delta	SER-YU			
Right-Left	SSR-2X			
Dishwasher Relay	ERB-50			

### ASTRONOMIC TIME RELAYS

Astronomic+ 15 Programmes	DTR-10	DTR-10t		
Astronomic+ 32 Programmes	DTR-20	DTR-20S/TS	DTR-20M	DTR-25

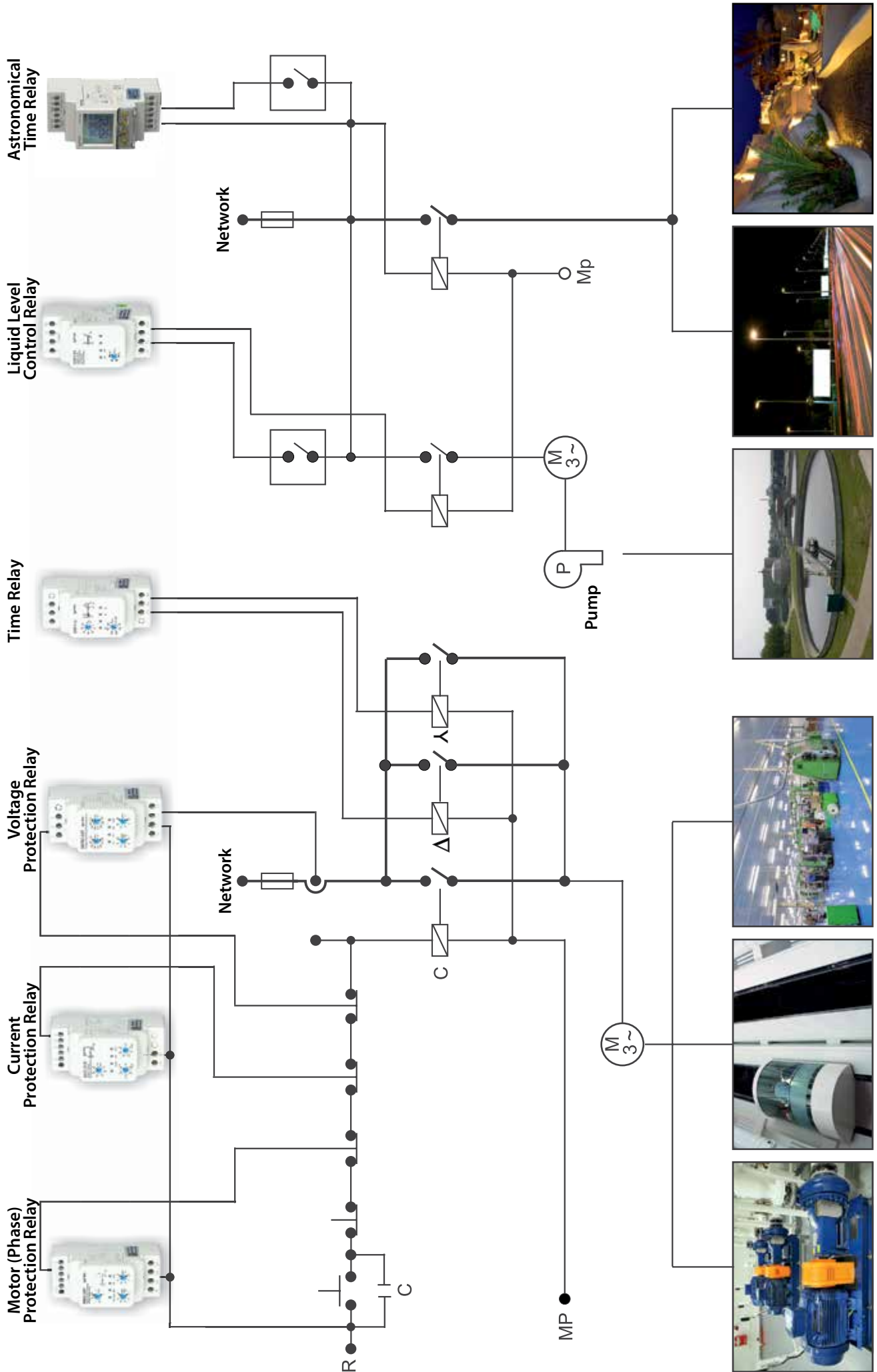



### Control Transformers



## ENT.PST Series

ENTES Control Transformers ensure safe operation of devices with 24 VAC output voltage. In addition to 230V or 400V constant input options, alternative input voltage (400; 230+15-15) options are also available.

Control Transformers are designed for continuous operation at 50°C ambient temperature. All ENTES Control Transformers are **CE** marked and compatible with EN standards.

### SPECIFICATIONS

- Compatible with TS.EN 61558-2-2
- Air-gapped sheet welding minimizing the body grounding resistance
- Vacuum impregnated varnish method, which increases efficiency by reducing heat losses, provides protection against humidity and quiet operation.
- Ability to maintain the nominal output value up to 50°C ambient temperature
- Iron core with high magnetic permeability
- High quality copper winding Class 1 transformer
- Minimum primary-secondary isolation voltage values: 2200 VAC for 400V transformers, 1800 VAC for 230V transformers

## Reliable 24VAC by ENTES Control Transformers...



### Benefit

ENTES Control Transformers are designed to provide secure 24VAC to ensure the safe operation of measuring devices.



### Application

Any electrical panel requires stable and reliable 24VAC.

**ENT.PST. Series**

	Nominal Power (VA)(at 50°C)	Short Term Power	Weight(kg)	Terminal Diameter	A (mm)	B (mm)	C (mm)	D (mm)	E (mm)	F (mm)	H (mm)
<b>230V / 24V</b>											
ENT.PST.2324.25	25	51	1	4 mm	66	76	80	50	64	80	5*8
ENT.PST.2324.50	50	97	1,5	4 mm	84	76	91	64	64	82	5*8
ENT.PST.2324.100	100	209	1,9	4 mm	84	76	91	64	64	96	6*9
ENT.PST.2324.160	160	338	2,4	4 mm	96	89	99	84	74	100	6*9
ENT.PST.2324.200	200	419	3	4 mm	96	89	99	84	74	100	6*9
ENT.PST.2324.250	250	559	3,4	4 mm	96	102	99	84	87	114	6*9
ENT.PST.2324.320	320	689	4,4	4 mm	120	90	127	90	83	92	6*9
ENT.PST.2324.400	400	961	5,6	4 mm	120	102	127	90	95	106	7*13
ENT.PST.2324.500	500	1260	7,1	4 mm	120	122	127	90	109	126	7*13
ENT.PST.2324.630	630	1520	7,6	10 mm	150	113	141	122	89	120	7*13
<b>400V / 24V</b>											
ENT.PST.4024.25	25	51	1	4 mm	66	76	80	50	64	80	5*8
ENT.PST.4024.50	50	96	1,5	4 mm	84	76	91	64	64	82	5*8
ENT.PST.4024.100	100	218	2	4 mm	84	76	91	64	64	96	6*9
ENT.PST.4024.160	160	344	2,4	4 mm	96	89	99	84	74	100	6*9
ENT.PST.4024.200	200	460	2,9	4 mm	96	89	99	84	74	100	6*9
ENT.PST.4024.250	250	584	3,4	4 mm	96	102	99	84	87	114	6*9
ENT.PST.4024.320	320	749	4,4	4 mm	120	90	127	90	83	92	6*9
ENT.PST.4024.400	400	909	5,5	4 mm	120	102	127	90	95	106	7*13
ENT.PST.4024.500	500	1241	7,1	4 mm	120	122	127	90	109	126	7*13
ENT.PST.4024.630	630	1556	7,6	10 mm	150	113	141	122	89	120	7*13

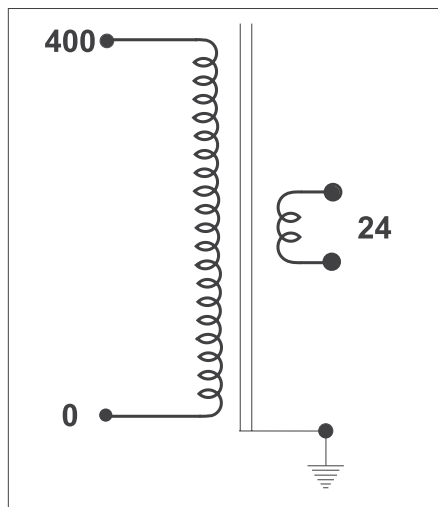
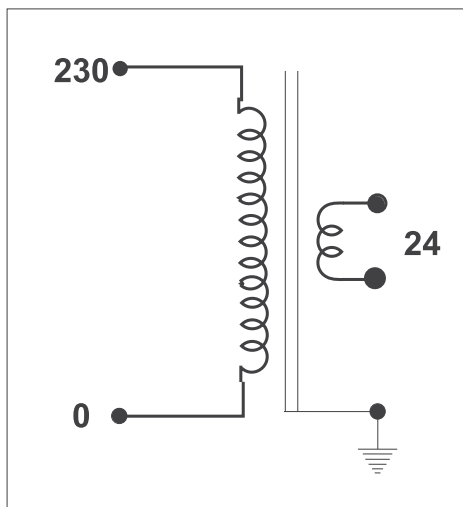

# ENT.PST. Series

## 400 - 230 / 24 V Alternative Input (15-0-15 V)

	Nominal Power (VA)(at 50°C)	Primary Voltage(V)	Short Term Power	Weight(kg)	Terminal Diameter	A (mm)	B (mm)	C (mm)	D (mm)	E (mm)	F (mm)	H (mm)
<b>400-230/24V</b>												
ENT.PST.A4024.25	25	400	51	1	4 mm	68	76	80	50	64	80	5*8
ENT.PST.A4024.50	50	400	97	1,5	4 mm	84	76	91	64	64	82	5*8
ENT.PST.A4024.100	100	400	218	2	4 mm	84	76	91	64	64	96	6*9
ENT.PST.A4024.160	160	400	344	2,4	4 mm	96	89	99	84	74	100	6*9
ENT.PST.A4024.200	200	400	460	2,9	4 mm	96	89	99	84	74	100	6*9
ENT.PST.A4024.250	250	400	584	3,4	4 mm	96	102	99	84	87	114	6*9
ENT.PST.A4024.320	320	400	749	4,4	4 mm	120	90	127	90	83	92	7*13
ENT.PST.A4024.400	400	400	909	5,5	4 mm	120	102	127	90	95	106	7*13
ENT.PST.A4024.500	500	400	1214	7,1	4 mm	120	122	127	90	109	126	7*13
ENT.PST.A4024.630	630	400	1556	7,6	10 mm 4 mm	150	113	141	122	89	120	7*13

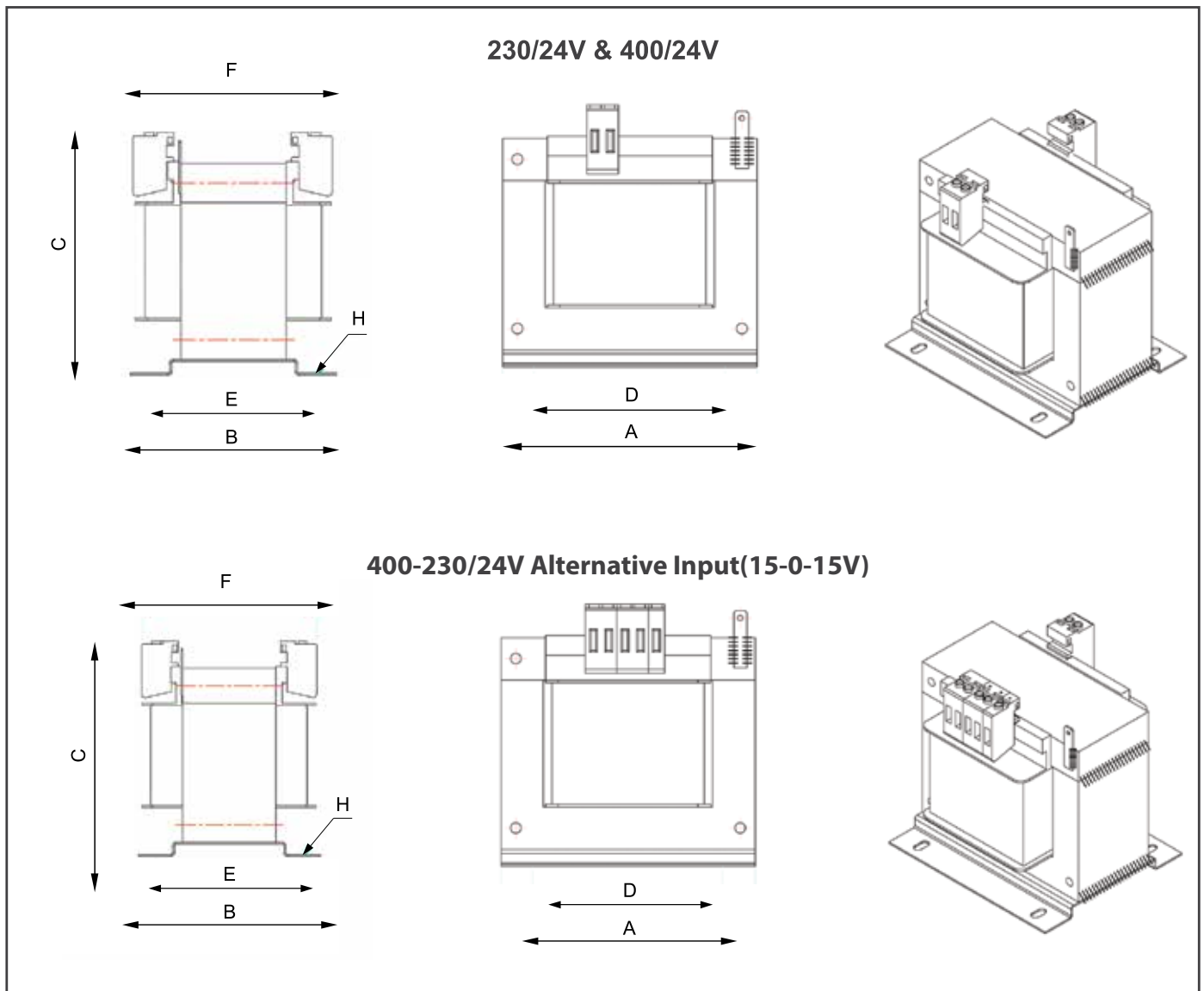
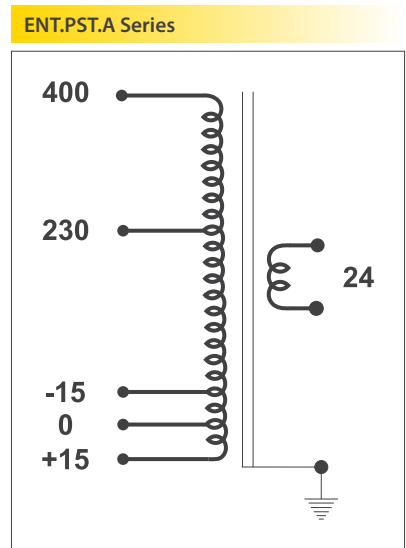

## Isolation Transformer

# ENT.IST Series



ENTES Isolation Transformers ensure safe operation of devices by isolating the secondary side from the primary voltage. Input and output voltages of isolation transformers are constant (230V or 400V). It is generally used to obtain a neutral point in places where galvanic isolation is required and in networks without a neutral point.

All insulation transformers compatible with **CE** mark and EN standards.

### SPECIFICATIONS

- Compatible with TS.EN 61558-2-2
- Vacuum impregnated varnish method, which increases efficiency by reducing heat losses, provides protection against humidity and quiet operation.
- Air-gapped sheet welding minimizing the body grounding resistance
- Ability to maintain the nominal output value up to 50°C ambient temperature
- Iron core with high magnetic permeability
- High quality copper winding Class 1 transformer
- High Efficiency

High isolation against to damaging impacts of voltage with ENTES Isolating Transformers...



### Benefit

ENTES Isolating Transformers are designed to protect equipments against to instantaneous changes on voltage.



### Application

Preferred by the industrial projects require protection of sensitive and valuable equipment.

## Isolation Transformer

	Nominal Power (VA)(at 50°C)	Short Term Power	Weight(kg)	Terminal Diameter	A (mm)	B (mm)	C (mm)	D (mm)	E (mm)	F (mm)	H (mm)
<b>230/230</b>											
ENT.IST.2323.25	25	51	1	4 mm	66	76	80	50	64	80	5*8
ENT.IST.2323.50	50	104	1,5	4 mm	84	76	91	64	64	82	5*8
ENT.IST.2323.100	100	199	2	4 mm	84	76	91	64	64	96	6*9
ENT.IST.2323.160	160	338	2,4	4 mm	96	89	99	84	74	100	6*9
ENT.IST.2323.200	200	428	2,9	4 mm	96	89	99	84	74	100	6*9
ENT.IST.2323.250	250	548	3,4	4 mm	96	102	99	84	87	114	6*9
ENT.IST.2323.320	320	701	4,4	4 mm	120	90	127	90	83	92	6*9
ENT.IST.2323.400	400	959	5,4	4 mm	120	102	127	90	95	106	7*13
ENT.IST.2323.500	500	1259	7,1	4 mm	120	122	127	90	109	126	7*13
ENT.IST.2323.630	630	1493	8,1	4 mm	150	113	141	122	89	102	7*13
<b>400/230</b>											
ENT.IST.4023.25	25	51	1	4 mm	66	76	80	50	64	80	5*8
ENT.IST.4023.50	50	95	1,5	4 mm	84	76	91	64	64	82	5*8
ENT.IST.4023.100	100	216	2	4 mm	84	76	91	64	64	96	6*9
ENT.IST.4023.160	160	330	2,5	4 mm	96	89	99	84	74	100	6*9
ENT.IST.4023.200	200	454	3	4 mm	96	89	99	84	74	100	6*9
ENT.IST.4023.250	250	555	3,6	4 mm	96	102	99	84	87	114	6*9
ENT.IST.4023.320	320	744	4,5	4 mm	120	90	127	90	83	92	6*9
ENT.IST.4023.400	400	942	5,6	4 mm	120	102	127	90	95	106	7*13
ENT.IST.4023.500	500	1174	7,1	4 mm	120	122	127	90	109	126	7*13
ENT.IST.4023.630	630	1555	8,3	4 mm	150	113	141	122	89	102	7*13

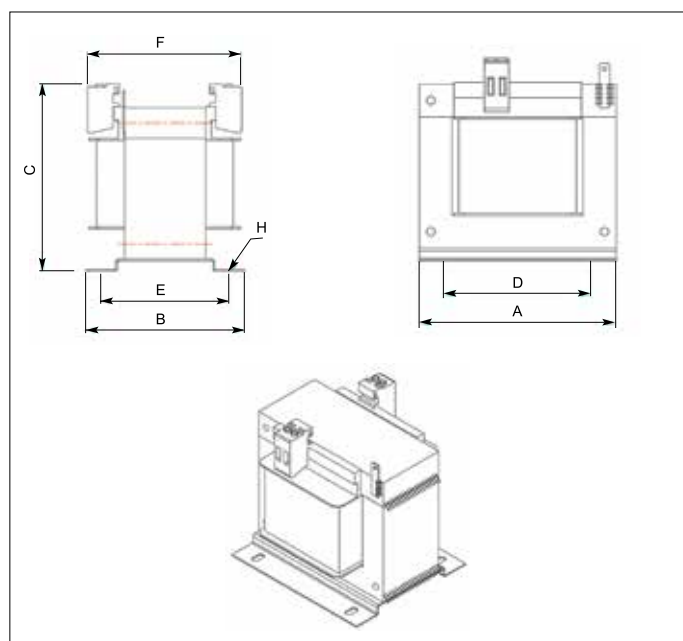
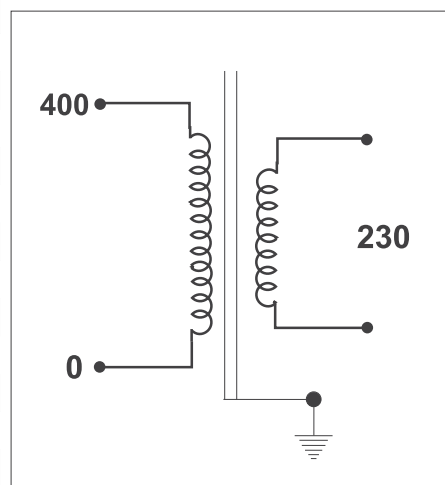
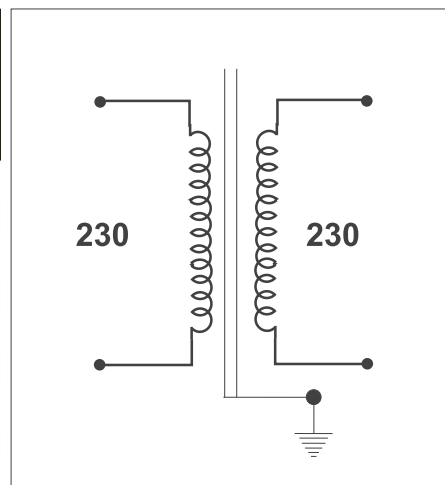



# ENTES Energy Management Solutions

ENTES Energy Management Solutions provide monitoring and analyzing the measured electrical parameters from a single center. With this method, many devices can be accessed and controlled via Ethernet and GPRS over the internet. Parameters at distant points can be analyzed and compared with the “Energy Medic” and “Enerthings” Softwares. Compensation can be tracked, energy consumption at different points can be compared and energy costs can be improved with this system.

## Usage Areas

- Electricity Distribution/Transmission Facilities
- Industrial Facilities
- Public Institutions
- Universities and Schools
- Mall
- Chain Stores
- Renewable Energy Production Facilities
- Radio Transmitters, Base Stations
- Hospitals
- Banks
- Airports and Harbors

## Energy Management Softwares

- Energy Medic
- Enerthings

## Energy Management Equipment

- ETMO Series
- GEMO Series
- EPC-12
- RS-USB2



**Direct access to your energy measurements from anywhere with ENTES Modems...**



## **ETMO/GEMO Modem Series**

**Self Powered**

**Configurable via USB Port**

**Isolated Digital Input and Output**

**Direct connection to EnerMedic**

**Meter Reading**

**2G or 3G Network Compatibility (GEMO)**

[www.entes.com.tr](http://www.entes.com.tr)



Energy Management Softwares

# EnerMedic and Enerthings



EnerMedic and Enerthings are integrated Energy Management Solutions developed by ENTES.

- EnerMedic is a cloud solution that allows you to solve many energy management problems without an additional investment cost and offers the flexibility to pay as you use with monthly and annual subscriptions. Enerthings, on the other hand, is our server-based solution developed for our customers who want to keep their energy management software in-house.

- Free Instant Monitoring And Configuration Via ENTES.NET
- Monitoring Capacitors With Step Maintenance
- Summary Display With Main Panel
- Monitoring Electrical Hazards With Energy Statistics
- Facility Construction And Management
- Energy Saving With Consumption Summary
- Observation On The Map
- Easy Management With User Alarms
- Reactive Ratio Tracking
- Virtual Device

## Cloud Solutions

## Server Solutions

PFC Doctor	EnerMedic	Enerthing My Cloud	Enerthings Corporate Cloud
Reactive Ratio Monitoring + Observation on the map + Unlimited myENTES access + Monitoring Your Panel (with Solution Partners) + Build facility	PFC Doctor Features + Monitoring your capacitors with step maintenance + Monitoring electrical hazards with energy statistics + Energy saving with consumption summary	All the features of the EnerMedic + Physical server	All the features of the EnerMedic + Visual server



## Energy Management Softwares

### ENTES.NET

For your devices which added via ENTES.NET;

- Instant monitoring can be done
- Devices can be configured
- Installation health can be checked for free.

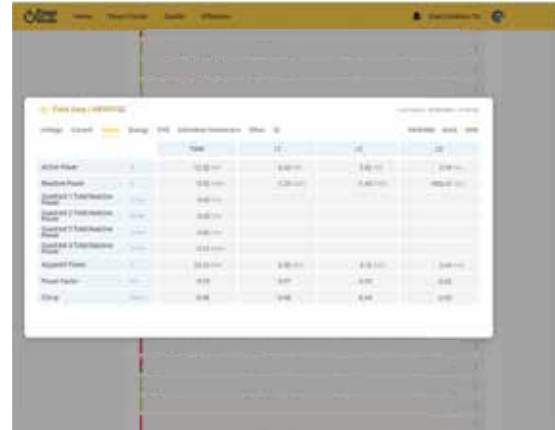

### Summary Display with Main Panel

The most needed features for energy management are briefly displayed to the users on the main panel, thus enabling easier monitoring of the facilities.



### Building Facility and Management

With the facility construction feature, all facilities are built floor by floor, section by section and load by load.

With ENTES Energy Efficiency Equipment, each load can be analyzed and managed at the required level of detail.



## Energy Management Softwares

### Observation on the Map

General status of all facilities can be viewed on the map. If necessary, the status of the facility can be observed in detail by clicking on the facility.

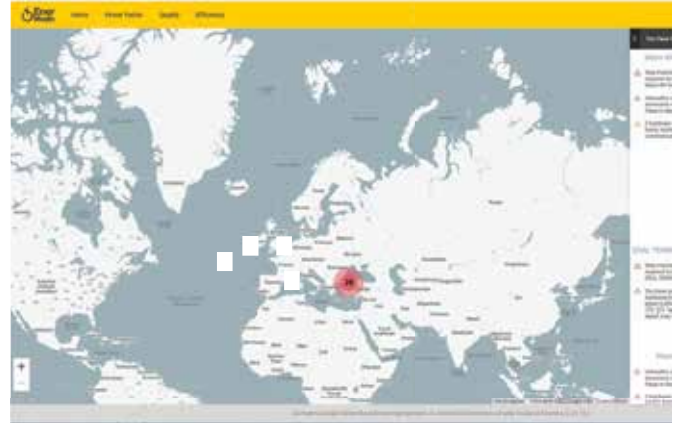

### Reactive Ratio Monitoring

Electricity consumption is constantly controlled, reactive rates are displayed with user-friendly interfaces.

By analyzing the reactive penalty risk, notifications are made before a problem occurs.

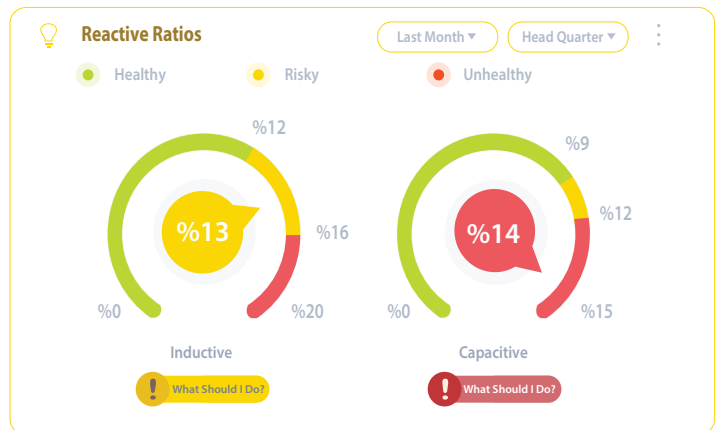

### Monitoring Capacitors with Step Maintenance

With the Step Maintenance feature, the capacitors connected to the steps are constantly monitored. Capacitors' capacities can be monitored instantaneously, and the health status of capacitors is displayed with user-friendly interfaces.

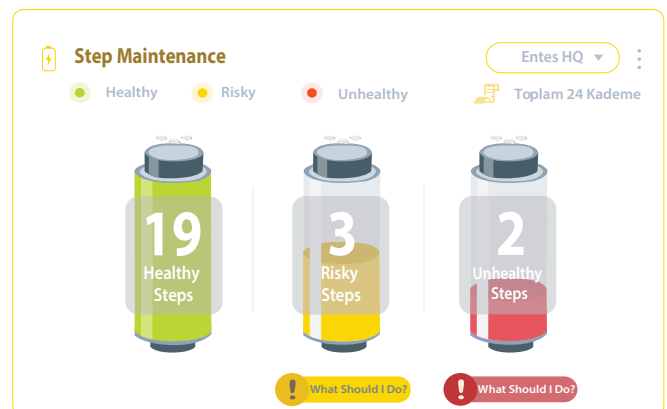

## Energy Management Softwares

### Energy Statistics and Electrical Hazards Tracking

Electrical hazards that may damage the facility are constantly monitored with energy quality measurements. Measured parameters are analyzed according to the limit values determined by standards, and displays are made about the health of the energy used.

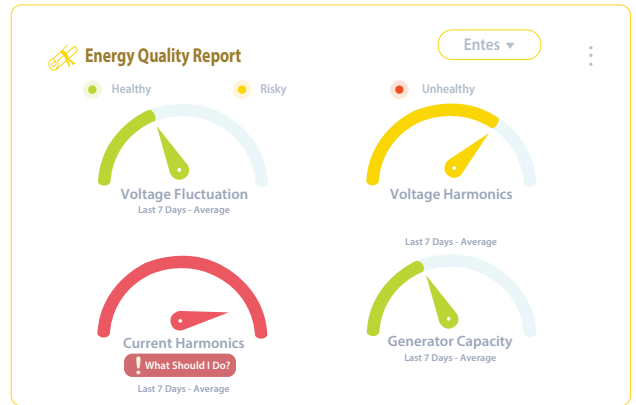

### Energy Saving with Consumption Summary

With Energy Efficiency Equipment, the consumption of loads in different categories is monitored, and energy costs are kept under control.

Consumptions in two different selected periods can be analyzed comparatively.



### Easy Management with User Alerts

With the user alarms menu, it is possible to create special alarms for any object (floor, section, load) in any facility, and a flexible management panel is offered to the users.

User Alarms

Alarm Scenarios

Message Name	Facility Scope	Affected Objects	Scenario Summary
Shut The Main Panel	ENTES Factory	Any Floor	EL_VLN1> 100 V Alarm
Shut The General Lightning	Any "Center"	Any Section	EL_THDVL1> 3% Warning
Temperature	ENTES Factory	Main Panel	AMB_C> 30 °C Alarm
Over Voltage	Any Facility	Any Object	EL_VLN1> 150 V Warning
Add a new scenario	Any Facility	Any Object	Scenario summary appears automatically

Save

### Virtual Device

For the points where measurement cannot be made, the virtual device & virtual parameters are defined and the mathematically calculated measurement values are displayed as if a device is measuring.



Energy Management Equipment

# ETMO Series Ethernet Modems



**ETMO-10 / ETMO-02 / ETMO-02-DR  
RS-485/RS-232 / USB/Ethernet Modem**

ETMO modems are devices that allow devices connected to the serial port via Ethernet to be read as Modbus-TCP or Transparent. The DR version of the products can be used with EnerMedic without the need for any configuration from the factory.



## Product Comparison Chart

Product Model	Product Description
ETMO-10	85-265 VAC/DC Ethernet Modem (maximum 32 devices)
ETMO-02	85-265 VAC/DC Ethernet Modem (maximum 2 devices)
ETMO-02-DR	85-265 VAC/DC Ethernet modem with EnerMedic configuration (maximum 2 devices)

Category	Description
Communication Protocols	MODBUS TCP / MODBUS RTU / TCP TRANSPARAN / HTTP
Serial Ports	USB (Configuration),RS-485, RS-232, ETHERNET
Operating Modes	ModbusTCP/RTU and Transparan
Ethernet Interface	10/100 Mbps auto-negotiation,
Transfer Rate	300-115200 bps
Protection Class	Terminal: IP00, Enclosure Protection Class: IP51, Front Panel: IP40
Enclosure Type	DIN 3 (RAIL MOUNTING)

## Energy Management Equipment



# GEMO Series GSM Modems

### GEMO-10-SH-3G / GEMO-10-DR/GEMO-10-3G/GEMO-10-2G/GEMO-02-DR-GEMO-02 GSM/ETHERNET/USB Modem

GEMO modems are devices that allow the devices connected to the serial port to be read as Modbus-TCP or Transparent, over GSM-2G-3G connections and optionally over Ethernet. The DR version of the products can be used with EnerMedic without the need for any configuration from the factory.

## Product Comparison Chart

Product Model	Product Description
GEMO-10-SH-3G	85-265VAC/DC Eth 3G GSM Meter Reading Gateway (maximum 32 devices)
GEMO-10-DR	85-265VAC/DC 3G GSM modem DR ver. (maximum 32 devices)
GEMO-10-3G	Ethernet GPRS Modem (maximum 32 devices)
GEMO-10-2G	Ethernet GPRS Modem (maximum 32 devices)
GEMO-02-DR	85-265VAC/DC 3G GSM modem DR ver. (maximum 2 devices)
GEMO-02	85-265VAC/ DC 3G GSM modem (maximum 2 devices)

Category	Description
Communication Protocols	MODBUS TCP / MODBUS RTU / TCP TRANSPARENT / Meter reading (Virtual Serial Port) / http / IEC62056 Meter Reading Protocol (GEMO-10-SH)
Serial Ports	RS-485, RS-232
Communication Interfaces	USB (Configuration) , Ethernet, GSM(3G/2G)
Operating Modes	ModbusTCP/RTU and Transparen
Ethernet Interface	10/100 Mbps auto-negotiation,
GSM Interface	for 2G Models: GSM/GPRS/EDGE for 3G Models :UMTS/HSPA and GSM/GPRS/EDGE
Transfer Rate	300-115200 bps
Protection Class	Terminal: IP00, Enclosure Protection Class: IP51, Front Panel: IP40
Enclosure Type	DIN 3 (RAIL MOUNTING)

Energy Management Equipment

# EPC - 12 Pulse Concentrator



- Data collection feature from electricity, water, gas meters
- 12 different counter inputs
- Defining 8 different tariffs for each weekday, Saturday, Sunday and other holidays
- Summer-winter time application
- RS-485 communication



### RS-485 USB Converter

It is used for computer communication of Modbus communication devices with RS-485 / USB Converter.

- Supports USB 1.1 and USB 2.0 300 - 115,200 bps transfer rate
- Automatic flow control for RS-485
- Minimum 3000 VDC insulation
- Activation LED
- Can be powered from USB port and does not need external power supply
- Automatic "transfer rate" identification ESD (Electro-static discharge) protection

## EMM Series Multimeter

ECONOMIC, ELEGANT and RELIABLE



# Compensation

ENTES Compensation products are designed to prevent the consumption of reactive energy (kVA<sub>rh</sub>) more than the rates determined in the regulation. In this way; Users are prevented from paying reactive costs and energy costs are reduced by reducing losses in transmission/ distribution lines.

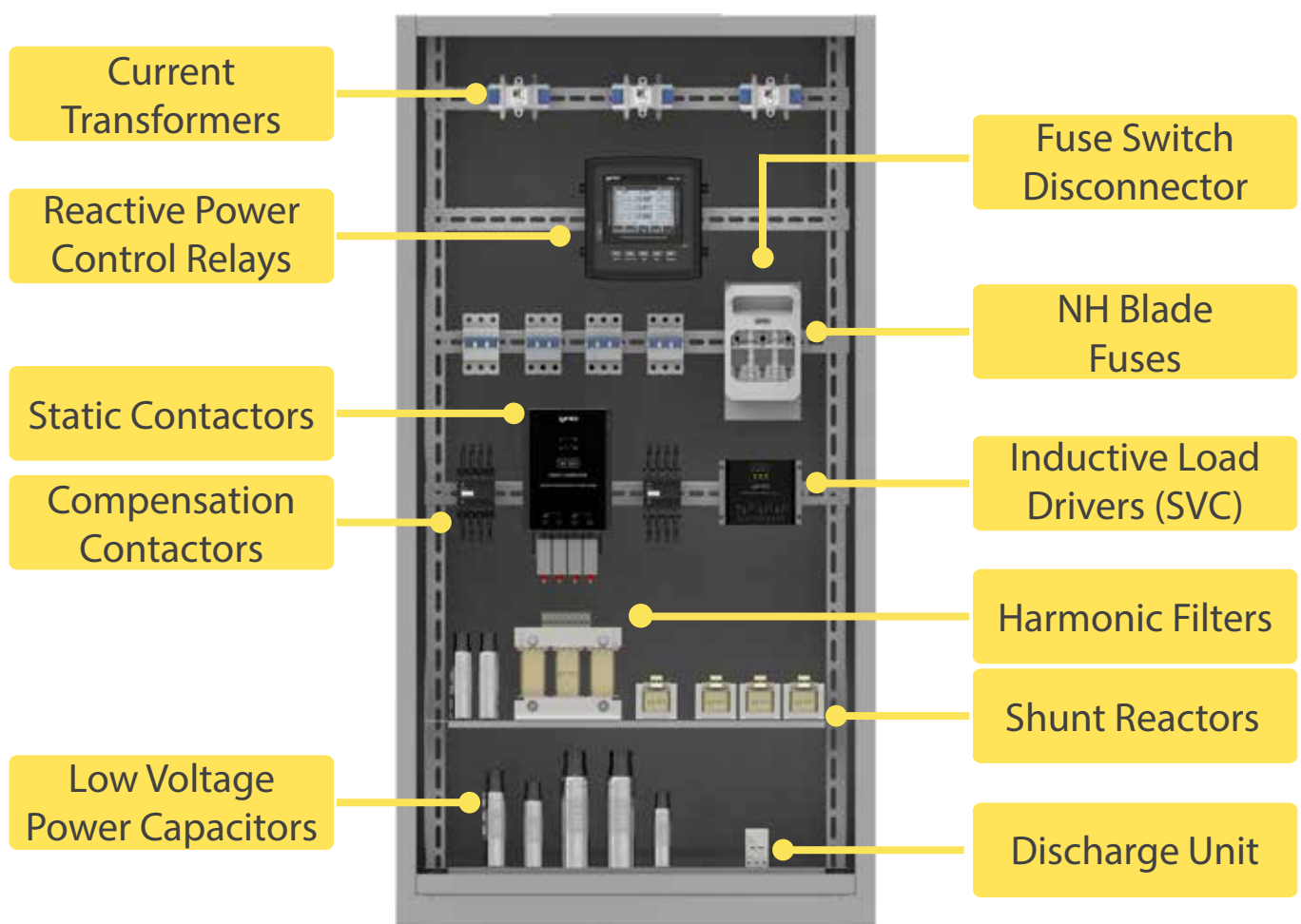



## Reactive Power Control Relays

Thanks to wide feature of RGI series single phase reactive power control relays, all electrical parameters are received by one current transformer in systems with balanced loads and required compensation is made.

With RG-T Series Reactive Power Control Relays, compensation can be made by measuring current information from a single phase in systems with balanced loads.

RG3 Series devices provide compensation by measuring the voltage and current of 3 phases separately in systems with unbalanced loads.

RG3-15CL/CLS Relays provide a definitive solution for compensation of inductive and capacitive loads by controlling both capacitor and shunt reactors.

The new RGA and RGSR Series Reactive Power Control Relays offer a superior Compensation experience with its Graphic LCD screen, high measurement accuracy and driver support. RGSR and RGP-SR Series Reactive Power Control Relays, with their SVC features, work together with Inductive Load Drivers in businesses where the unbalanced load changing rapidly and precisely eliminate the unbalance of each phase. The new generation RGP Series Reactive Power Control Relays have a patented and award-winning design that tells the Compensation status with a smileyR (smiley face) without going to the device.



## Product Comparison Chart

Product Name	Step	Dimensions/mm	Shunt Reactor	SVC	MV (Medium Voltage)	1 Phase, 1 Current Transformer (Balanced Network)	3 Phase, 3 Current Transformer	1 Phase Capacitor	3 Phase Capacitor	Total Active, Reactive and Apparent Power	Active and Reactive Energy	THD Protection	1-19, Current and Voltage Harmonics	1-31, Current and Voltage Harmonics	1-51, Current and Voltage Harmonics	Dual Target Cosp	Automatic Setup	Password Protection	RS-485 Communication	Internal Temperature Sensor	Contact Output
RGI-4W	4	144x144	●			●			●	●	●			●		●	●	●			
RGI-6SW	6	144x144	●			●			●	●	●			●		●	●	●	●	●	●
RGI-9SW	9	144x144	●			●			●	●	●			●		●	●	●	●	●	●
RGI-12SW	12	144x144	●			●			●	●	●			●		●	●	●	●	●	●
RG-6T	6	144x144				●			●												
RG-8T	8	144x144				●			●												
RG-12T	12	144x144				●			●												
RG3-12e	12	144x144					●	●	●			●						●	●		
RG3-12C	12	144x144					●	●	●	●	●	●	●			●	●	●		○	●
RG3-12CS	12	144x144					●	●	●	●	●	●	●			●	●	●	●	○	●
RG3-15C	15	144x144					●	●	●	●	●	●	●			●	●	●			●
RG3-15CS	15	144x144					●	●	●	●	●	●	●			●	●	●	●		●
RG3-15CL	15	144x144	●				●	●	●	●	●	●	●			●	●	●			●
RG3-15CLS	15	144x144	●				●	●	●	●	●	●	●			●	●	●	●		●
RGP-9S	9	144x144	●				●	●	●	●	●	●		●		●	●	●	●		●
RGP-12S	12	144x144	●				●	●	●	●	●	●		●		●	●	●	●	○	●
RGP-12SR	9 + SVC	144x144	●	●			●	●	●	●	●	●		●		●	●	●	●		●
RGP-15SR	12 + SVC	144x144	●	●			●	●	●	●	●	●		●		●	●	●	●	○	●
RGA-15S	15	144x144	●				●	●	●	●	●	●			●	●	●	●	●		●
RGA-20S	20	144x144	●				●	●	●	●	●	●			●	●	●	●	●		●
RGA-24S	24	144x144	●				●	●	●	●	●	●			●	●	●	●	●		●
RGSR-15S	12 + SVC	144x144	●	●			●	●	●	●	●	●			●	●	●	●	●		●
RGSR-20S	16 + SVC	144x144	●	●			●	●	●	●	●	●			●	●	●	●	●		●
RGSR-24S	20 + SVC	144x144	●	●			●	●	●	●	●	●			●	●	●	●	●		●
RGA-20S-OG	24	144x144	●		●		●	●	●	●	●	●			●	●	●	●	●		●
RGSR-24S-OG	20 + SVC	144x144	●	●	●		●	●	●	●	●	●			●	●	●	●	●		●

○ Optional

ENTES 3-phase reactive power control relays provides a unique solution for balanced and unbalanced loads by compensating with three-phase capacitors until the unbalance of 3 phases starts, and with single-phase capacitors in phases where there is unbalance.

## Reactive Power Control Relays

# RGI Series



RGI Series Reactive Power Control Relays switch 3-phase capacitor and 3-phase shunt reactor steps in balanced systems as needed.

Models with 4, 6, 9, 12 steps are available to meet optimum requirements for compensation. The universal 4-button design and the redesigned menu structure within the framework of expectations from a compensation relay offer ease of use.

RGI Series Reactive Power Control Relays work fully integrated with EnerMedic and Enerthings. Energy Management Softwares and promise a unique user experience to users.



### Product Comparison Chart

Product Name	Step	Dimensions/mm	Segment LCD	Shunt Reactor	1 Phase 1 Current	Three Phase Capacitor	V, I, Cosp, W, VA, VA	$\Sigma W, \Sigma VA, \Sigma VA, kWh, kVAh$	THDV/THDI	Individual Harmonic	RS-485 Communication	Temperature Measurement/Fan Output	Generator Trigger Cosp	90-550V AC/DC (AUXILIARY SUPPLY)
RGI-4W	4	144x144	●	●	●	●	●	●	●	31			●	●
RGI-6W	6	144x144	●	●	●	●	●	●	●	31			●	●
RGI-6SW	6	144x144	●	●	●	●	●	●	●	31	●	●	●	●
RGI-9W	9	144x144	●	●	●	●	●	●	●	31			●	●
RGI-9SW	9	144x144	●	●	●	●	●	●	●	31	●	●	●	●
RGI-12W	12	144x144	●	●	●	●	●	●	●	31			●	●
RGI-12SW	12	144x144	●	●	●	●	●	●	●	31	●	●	●	●



### Benefit

RGI Series Power Factor Correction Relays are designed to control switching 3-phase capacitors or 3-phase shunt reactors to compensate reactive power in balanced networks. Reactive power control provides additional benefits such as efficient use of generators and transformer capacities, decreased cable loss, voltage regulation.



### Application

Electrical system applications in industrial or commercial facilities obligated Power Factor Correction by domestic regulations.

## Reactive Power Control Relays



## RGP Series

RGP Series Reactive Power Control Relays stand out with their standard and SVC supported versions, wide segment LCD screen and unique features that provide ease of use.

With 9 and 12 step options, the RGP Series has the infrastructure that provides optimum compensation with the minimum number of steps.

The patented and design-awarded Smiley feature of the RGP Series allows you to understand the compensation status with smiley and different screen colors without going near the device.

The universal 4-button design and the redesigned menu structure within the framework of expectations from a compensation relay offer ease of use.

RGP Series Reactive Power Control Relays work fully integrated with EnerMedic and Enerthings Energy Management Softwares and promise a unique user experience to users.

### Product Comparison Chart

Product Name	Maximum Step Number	144x144	Segment LCD	SVC	Shunt Reactor	3 Phase 3 Current	Single Phase Capacitor	Three Phase Capacitor	V, I, Cosφ, W, Var, VA	Σ W, Σ VA, Σ VA kWh, kVAh	% THD I, THDV	Individual Harmonic	RS-485 Communication	Temperature Measurement / Fan Output	Generator Trigger Cosp	100-270VAC/DC
RGP-9S	9	●	●		●	●	●	●	●	●	●	31	●		●	●
RGP-12S	12	●	●		●	●	●	●	●	●	●	31	●		●	●
RGP-12SR	9+SVC	●	●	●	●	●	●	●	●	●	●	31	●		●	●
RGP-15SR	12+SVC	●	●	●	●	●	●	●	●	●	●	31	●	○	●	●

Award-Winning and Patented ENTES RGP Series Power Factor Correction Relay Series Reduces Energy Costs while improving the Energy Quality.

### Benefit

RGP Series Power Factor Correction Relays are designed to prevent undesirable reactive costs by controlling the power factor. Reactive power control provides additional benefits such as efficient use of generators and transformer capacities, decreased cable loss, voltage regulation.

### Application

Electrical system applications in industrial or commercial facilities obligated Power Factor Correction by domestic regulations.

## Reactive Power Control Relays

# RGA Series



RGA Series Reactive Power Control Relays are designed to meet all kinds of compensation needs with their innovative structure and superior features.

With the support of the newly developed Intelligent Compensation Algorithm and the unbalance removal capability, the steps are easily and quickly managed. With the serial and intelligent step management, the problems in the components in the compensation panel can be detected and displayed, and alarms can be generated. Undesirable situations such as capacitor derating measurements and contactor sticking can be detected instantly by the RGA.

The RGA Series also supports the use of shunt reactors and capacitors together to respond to the load created by capacitive devices. With its advanced infrastructure and algorithms, it can automatically recognize the levels and fix the connections.



## Product Comparison Chart

Product Name	Dimension (mm)	Second Current Transformer	Smart Compensation Moods	Graphic LCD	3 Phase, 3 Current	Maximum Step Number	Smart Switching	Single Phase Capacitor	Shunt Reactor	Three Phase Capacitor	Voltage(V)/Current(I)	Cosp	Power Factor	Active Power(W)	Reactive Power (W)	Apparent Power (VA)	kWh, kVAh, kVAh	%THD I, %THD V	Individual Harmonic	RS-485 Communication	Generator Trigger Cosp	100-270 VAC/DC
RGA-8S	144x144	●	●	●	●	8	●	●	●	●	●	●	●	●	●	●	●	●	51	●	●	●
RGA-12S	144x144	●	●	●	●	12	●	●	●	●	●	●	●	●	●	●	●	●	51	●	●	●
RGA-15S	144x144	●	●	●	●	15	●	●	●	●	●	●	●	●	●	●	●	●	51	●	●	●
RGA-20S	144x144	●	●	●	●	20	●	●	●	●	●	●	●	●	●	●	●	●	51	●	●	●
RGA-24S	144x144	●	●	●	●	24	●	●	●	●	●	●	●	●	●	●	●	●	51	●	●	●



See page 63 for energy monitoring software.

## Reactive Power Control Relay



# RGSR Series

RGSR Series Reactive Power Control Relays are designed to meet all kind of driver compensation needs with their innovative structure and superior features.

ENTES SVC Compensation's solution is ENTES Driver Compensation System, which provides the most ideal solution in systems with rapidly changing unbalanced loads. This system, which responds quickly to load changes in less than 20ms; It provides a precise compensation solution in applications such as companies using spot welding, rolling mills, cranes, elevators, automotive industry and hospitals.

In ENTES SVC solution, inductive load drivers connected to RGSR Series Reactive Power Control Relays are designed to drive 3 single-phase shunt reactors at full load. In this way, shunt reactors can be activated in an adjustable manner by triggering the powers at certain angles by means of thyristors.

ENTES's 5 kVAR, 10 kVAR, 20 kVAR, 30 kVAR inductive load drivers switch very quickly to even the lowest loads by activating the shunt reactors connected to the phases as needed.

It can achieve perfect solution for capacitive loads by using single-phase shunt reactors of 1.66 kVAR, 3.33 kVAR, 6.66 kVAR and 10 kVAR, specially produced for ENTES's SVC solution.

## Product Comparison Chart

Product Name	Dimension (mm)	Second Current Transformer	Smart Compensation Moods	Graphic LCD 3 Phase, 3 Current	Maximum Step Number	Smart Switching	Single Phase Capacitor	Shunt Reactor	Three Phase Capacitor	Voltage(V)/ Current(I)	Cosp	Power Factor	Active Power (W)	Reactive Power (W)	Apparent Power (VA)	kWh, kVARh, kVAh	%THD I, %THD V	Individual Harmonic	RS-485 Communication	Generator Trigger Cosp	100-270 VAC/DC
RGSR-15S	144x144	●	●	●●	12+SVC	●	●	●	●	●	●	●	●	●	●	●	●	51	●	●	●
RGSR-20S	144x144	●	●	●●	16+SVC	●	●	●	●	●	●	●	●	●	●	●	●	51	●	●	●
RGSR-24S	144x144	●	●	●●	20+SVC	●	●	●	●	●	●	●	●	●	●	●	●	51	●	●	●



See page 63 for energy monitoring software.

## Reactive Power Control Relays

# RGA / RGSR OG Series Medium Voltage Reactive Power Relays



In enterprises located at the entrance of the MV power transformer of the electricity meter; Constant group capacitor needs change due to the variable losses of the transformer, especially on holidays when the transformer is idle running or the businesses which is working seasonal is closed, and this causes the compensation rates to increase and for this reason the company has to pay reactive cost. RGA and RGSR-OG Series Reactive Power Control Relays, with their innovative structure and superior features, in businesses which have the M.V Power Transformers are designed to meet the above-mentioned variable constant group needs and all kinds of compensation needs.



## Product Comparison Chart

Product Name	Dimension (mm)	Second Current Transformer	M.V.	SVC	Smart Compensation Moods	Graphic LCD	Phase,3 Current	Maximum Step Number	Smart Switching	Single Phase Capacitor	Shunt Reactor	Three Phase Capacitor	Voltage(V)/ Current(I)	Cosp	Power Factor	Active Power(W)	Reactive Power (W)	Apparent Power (VA)	kWh, kVArh, kVAh	%THD I, %THD V	Individual Harmonic	RS-485 Communication	Generator Trigger Cosp	100-270 VAC/DC
RGA-20S-OG	144x144	●	●		●	●	●	20	●	●	●	●	●	●	●	●	●	●	●	●	51	●	●	●
RGA-24S-OG	144x144	●	●		●	●	●	24	●	●	●	●	●	●	●	●	●	●	●	●	51	●	●	●
RGSR-20S-OG	144x144	●	●	●	●	●	●	16+SVC	●	●	●	●	●	●	●	●	●	●	●	●	51	●	●	●
RGSR-24S-OG	144x144	●	●	●	●	●	●	20+SVC	●	●	●	●	●	●	●	●	●	●	●	●	51	●	●	●



## Benefit

OG series Reactive Power Control products, in enterprises where the electricity meter is at the entrance of the M.V power transformer; It prevents reactive cost payment, especially on holidays when the transformer is idle running or during the off-season periods of seasonal businesses.



## Usage Areas

It should be used in enterprises where the electricity meter is located at the entrance of the M.V. power transformer, in GES, RES and BES.

## SR Series



# SR Series Inductive Load Drivers

\*ENTES's 5kVAr, 10kVAr, 20kVAr and 30kVAr Inductive Load Drivers can switch very quickly to even the lowest loads by activating the shunt reactors connected to the phases in the SVC system, as needed.

\*A perfect solution for capacitive loads can be obtained by using single-phase shunt reactors of 1.66kVAr, 3.33kVAr, 6.66kVAr and 10 kVAr, specially produced for ENTES's SVC solution.

### Technical Features:

- Operating Temperature -10, +55°C Storage Temperature -20, +70°C
- Supply Voltage 210-250 VAC (L-N):  $\sqrt{3}$  \*Un (L-L) Frequency 45-65Hz
- Max. Humidity %95 / Response time less than 20ms Easy to install / Fan Cooling (SR-30E)



## Product Comparison Chart

Product Name	Power(kVAr)	Number of Shunt Reactors	Shunt Reactor Type	Operating Voltage	Connection Type	Dimension(mm)	Weight(kg)
SR-05E	5	3	Monaphase (Single Phase)	230	Star	119x121x92	0,9
SR-10E	10	3	Monaphase (Single Phase)	230	Star	119x121x152	1,4
SR-20E	20	3	Monaphase (Single Phase)	230	Star	119x162x337	2,29
SR-30E	30	3	Monaphase (Single Phase)	230	Star	119x167x337	3,18

Accurate Correction of Power Factor with **ENTES SR Series** Inductive Load Drivers...



### Benefit

ENTES SR Series Power Factor Correction Relays are ideal for the fast changing unbalanced loads.



### Usage Areas

In parallel with technological developments, applications such as LED lighting and UPS produce capacitive effect with increasing momentum. Conventional power factor correction methods may be insufficient in plants where instantaneous loads are required for the applications like lifts, spot welders and cranes and businesses face reactive cost. SR Series Inductive Load Drivers are innovative precise solution to reach your power factor targets.



# Medium Voltage Current Transformers

Medium Voltage current transformers work together with reactive power control relays that receive current information from medium voltage.

With the advanced insulation level, the medium voltage power transformer is mounted on the XLPE cables on the primary side and current measurement is made by the MV.

### Usage Areas

Enterprises that electricity meter is located at the entrance of the MV Power Transformer.



## Technical Features

Product Name	Maximum Busbar Size (mm)	Primary Current (A)	Nominal Power (VA)	Class 0,5	Class 0,5S	pcs/box
ENT.A65-OG 30/1	65	30	1	●		3
ENT.A65-OG 40/1	65	40	1,5	●		3
ENT.A65-OG 50/1	65	50	2,5	●		3
ENT.A65-OG 100/5	65	100	5		●	3
Operating Frequency	50 Hz					
Insulation Test Voltage(Ui)	3 kV eff, 1 min					
Maximum Operating Voltage(Um)	0,72 kV					
Over Current Factor	n<5 (Ip ≤ 2000 A)					
Continuous Operating Current	1,2 x Ip					
Thermal Short-Circuit Current(Ith)*	60 x Ip					
Dynamic Rated Current (Idyn)*	2,5 x Ith					
Operating Temperature	-5 °C / +45 °C					
Standard	TS EN 61869-2					
pcs/box	3					

### \* About thermal short-circuit current (Ith) and dynamic nominal current (Idyn)

Ith is the maximum effective primary current that the current transformer can operate for 1 second without fail in case of overload caused by short circuits on the secondary side. Idyn is the maximum peak current that the current transformer can operate in the same time without fail.

**MV Current Transformers are used only with insulated MV XLPE cable.**

**Direct mounting to MV busbars should never be done.**



## Low Voltage Power Capacitors



## Low Voltage Power Capacitors

- Trouble-free operation under severe conditions
- Safe operation with overpressure disconnecter system
- Self healing feature
- Robust body and compact design

ENTES Power Capacitors are designed in accordance with harsh conditions and adverse conditions that will shorten their life during compensation. With the overpressure disconnecter system, the capacitors are prevented from bursting at the end of the capacitor's life or in electrical thermal overloads.

ENTES Capacitors are manufactured using metallized polypropylene film with self-healing properties.

Disruptive effects occur during the activation of compensation capacitors. The inrush current of the activated capacitor reduces the life of both itself and the other capacitors in the circuit. The most appropriate way to eliminate these negativities is to use capacitors together with compensation contactors.

Increase your efficiency by monitoring your capacitors' health remotely!



### Benefit

Capacitors compensate inductive reactive loads. ENTES Low Voltage Power Capacitors are designed resistant to harsh conditions to provide you the longest usage time.

## Low Voltage Power Capacitors

Model	CF Series	CM Series	CMD Series	CXD.H Series	CXD Series
Operating Frequency	50/60Hz	50/60Hz	50/60Hz	50/60Hz	50/60Hz
Capacity Tolerance	%-5+%10	%-5+%10	%-5+%10	%-5+%10	%-5+%10
Dielectric Losses	≤0,3 W/kVAr	≤0,2 W/kVAr	≤0,2 W/kVAr	≤0,2 W/kVAr	≤0,2 W/kVAr
Operating Height	≤2000 m	≤2000 m	≤2000 m	≤2000 m	≤2000 m
Test Voltage (Terminal-Terminal)	2,15 x Un, AC 2 s	2,15 x Un, AC 2 s	2,15 x Un, AC 2 s	2,15 x Un, AC 2 s	2,15 x Un, AC 2 s
Test Voltage (Terminal-Housing)	3 kV, AC 10 s	3 kV, AC 10 s	3 kV, AC 10 s	3 kV, AC 10 s	3 kV, AC 10 s
Operating Temperature	-25+55°C	-25+55°C	-25+55°C	-25+55°C	-25+55°C
Maximum Allowed Voltage	1,1xUn	1,1xUn	1,1xUn	1,1xUn	1,1xUn
Maximum Allowed Current	2 x In	4 x In	3 x In	4 x In	4 x In
Maximum Starting Current	100 In	200 In	200 In	200 In	200 In
Protection Class	IP00	IP00	IP20	IP20	IP20
Discharge Resistors	External, 60 sec. then 50V	External, 60 sec. then 50V	Internal, 60 sec. then 50V	Internal, 60 sec. then 50V	Internal, 60 sec. then 50V
Standard	IEC 60831-1/2	IEC 60831-1/2	IEC 60831-1/2	IEC 60831-1/2	IEC 60831-1/2

### CM - CF Series (Single Phase)

Product Name	80.000 Hour	110.000 Hour	Qn (kVAr) for 230 VAC	400 VAC for Qn (kVAr)	C (uF)	In (A)	Dimensions DxH (mm)	Package Dimensions	Operating Temperature	Quantity in Package	Package Weight (kg)
ENT.CF-230-0,26	●		0,26	0,8	15	1,2	40x72	195x390x250	-400+ 750	100	10
ENT.CF-400-1,67	●		0,55	1,67	33,2	4,2	50x122	195x390x200	-250+ 550	25	7,3
ENT.CF-400-2,5	●		0,83	2,5	50	6,25	55x132	195x390x255	-250+ 550	25	9,5
ENT.CF-400-4,17	●		1,38	4,17	83	10,4	60x137	195x390x255	-250+ 550	18	7,7
ENT.CM-400-8,33		●	2,76	8,33	165,8	20,8	65x165	195x390x255	-250+ 550	16	9,8
ENT.CF-230-5		●	5		300	20,7	75x180	190x285x265	-400+ 700	6	5,5
ENT.CF-230-10		●	10		600	43	85x280	190x285x375	-400+ 700	6	10,7

Please contact us for 60Hz capacitors.

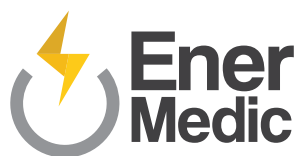

You can monitor the reactive power consumption of your businesses with EnerMedic.

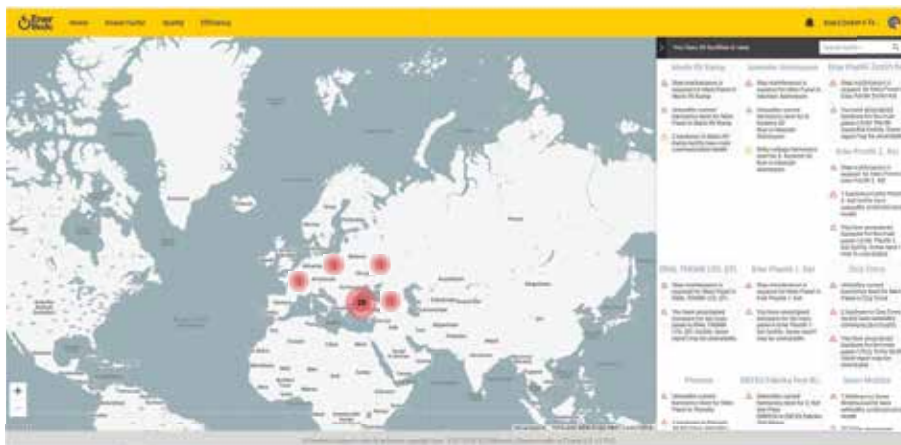

# Compensation

## CMD/CXD.H/CXD Series Three Phase Capacitors

Product Name	80.000 Hour	400 VAC for Qn (kVAr)	450 VAC for Qn (kVAr)	C (uF)	In (A)	Dimensions DxH (mm)	Package Dimensions	Operating Temperature	Quantity in Package	Package Weight (kg)
ENT.CMD-400-0,5	●	0,5		3x3,32	0,7	50x150	195x390x255	-25°C+55°C	21	5,5
ENT.CMD-400-1	●	1		3x6,63	1,4	50x150	195x390x255	-25°C+55°C	21	6
ENT.CMD-400-1,5	●	1,5		3x9,95	2,2	50x150	195x390x255	-25°C+55°C	21	7,5
ENT.CMD-400-2,5	●	2,5		3x16,6	3,6	60x150	195x390x255	-25°C+55°C	18	8,8
ENT.CMD-400-5	●	5		3x33,2	7,2	75x175	190x285x325	-25°C+55°C	6	5,3
ENT.CMD-400-7,5	●	7,5		3x49,7	10,8	75x265	190x285x345	-25°C+55°C	6	7,6
ENT.CMD-400-10	●	10		3x66,3	14,4	75x265	190x285x345	-25°C+55°C	12	15
ENT.CMD-450-0,5	●		0,5	3x2,62	0,6	50x150	195x360x255	-25°C+55°C	21	5,5
ENT.CMD-450-1	●		1	3x5,24	1,3	50x150	195x360x255	-25°C+55°C	21	6
ENT.CMD-450-1,5	●		1,5	3x7,86	1,9	50x150	195x360x255	-25°C+55°C	21	7,5
ENT.CMD-450-2,5	●		2,5	3x13,1	3,2	60x150	195x360x255	-25°C+55°C	18	8,8
ENT.CMD-450-5	●		5	3x26,2	6,4	75x175	190x285x325	-25°C+55°C	6	5,3
ENT.CMD-450-7,5	●		7,5	3x39,3	9,6	75x265	190x285x345	-25°C+55°C	12	7,6
ENT.CMD-450-10	●		10	3x52,4	12,8	75x265	190x285x345	-25°C+55°C	12	15

Please contact us for 60Hz capacitors.

Product Name	80.000 Hour	400 VAC for Qn (kVAr)	450 VAC for Qn (kVAr)	525 VAC for Qn (kVAr)	C (uF)	In (A)	Dimensions DxH (mm)	Operating Temperature	Quantity in Package	Package Weight (kg)
ENT.CXD.H-400-10	●	10			3x 66	14,4	75x255	-25°C+55°C	6	6,1
ENT.CXD.H-400-12,5	●	12,5			3x 83	18	75x255	-25°C+55°C	6	6,3
ENT.CXD.H-400-15	●	15			3x 99	21,7	85x255	-25°C+55°C	6	7,1
ENT.CXD.H-400-20	●	20			3x 133	28,9	90x255	-25°C+55°C	6	8,5
ENT.CXD.H-400-25	●	25			3x 166	36,1	116x255	-25°C+55°C	4	8,6
ENT.CXD.H-400-30	●	30			3x 199	43,3	116x255	-25°C+55°C	4	8,7
ENT.CXD.H-450-10	●		10		3x 52	12,8	75x255	-25°C+55°C	6	6,1
ENT.CXD.H-450-12,5	●		12,5		3x 65	16	75x255	-25°C+55°C	6	6,3
ENT.CXD.H-450-15	●		15		3x 79	19,2	85x255	-25°C+55°C	6	7,1
ENT.CXD.H-450-20	●		20		3x 105	25,7	90x255	-25°C+55°C	6	8,5
ENT.CXD.H-450-25	●		25		3x 131	32,1	100x255	-25°C+55°C	6	9,2
ENT.CXD.H-450-30	●		30		3x 157	38,5	116x255	-25°C+55°C	4	8,7
ENT.CXD.H-525-10	●			10	3x 157	11	75x255	-25°C+55°C	6	6,1
ENT.CXD.H-525-12,5	●			12,5	3x 48	13,7	75x255	-25°C+55°C	6	6,3
ENT.CXD.H-525-15	●			15	3x 58	16,5	85x255	-25°C+55°C	6	7,1
ENT.CXD.H-525-20	●			20	3x 77	22	90x255	-25°C+55°C	6	8,5
ENT.CXD.H-525-25	●			25	3x 96	27,5	100x255	-25°C+55°C	6	9,2
ENT.CXD.H-525-30	●			30	3x 115	33	116x255	-25°C+55°C	4	8,7

Please contact us for 60Hz capacitors.

## CMD/CXD.H/CXD Series Three Phase Capacitors

Product Name	110.000 Hour	400 VAC for Qn (kVAr)	450 VAC for Qn (kVAr)	525 VAC for Qn (kVAr)	C (uF)	In (A)	Dimensions DxH (mm)	Package Dimensions	Operating Temperature	Quantity in Package	Package Weight (kg)
ENT.CXD-400-5	●	5			3x33	7,2	75x165	195x390x255	-25°C+55°C	6	5,4
ENT.CXD-400-7,5	●	8			3x49	10,8	75x255	185x290x270	-25°C+55°C	6	7,9
ENT.CXD-400-10	●	10			3x66	14,4	75x255	185x290x270	-25°C+55°C	6	7,9
ENT.CXD-400-12,5	●	13			3x83	18	85x255	185x290x270	-25°C+55°C	6	9,6
ENT.CXD-400-15	●	15			3x100	21,7	90x255	185x290x270	-25°C+55°C	6	10,8
ENT.CXD-400-20	●	20			3x133	28,9	100x255	225x340x225	-25°C+55°C	6	13,2
ENT.CXD-400-25	●	25			3x166	36,1	116x255	330x340x225	-25°C+55°C	4	11,9
ENT.CXD-400-30	●	30			3x199	43,3	116x290	330x340x225	-25°C+55°C	4	13,4
ENT.CXD-400-40	●	40			3x265	57,7	116x370	270x270x450	-25°C+55°C	4	15
ENT.CXD-400-50	●	50			3x332	72,2	125x370	270x270x451	-25°C+55°C	4	16
ENT.CXD-450-5	●		5		3x26	6,4	75x165	195x390x255	-25°C+55°C	6	5,4
ENT.CXD-450-7,5	●		7,5		3x39	9,6	75x255	185x290x270	-25°C+55°C	6	7,9
ENT.CXD-450-10	●		10		3x52	12,8	75x255	185x290x270	-25°C+55°C	6	7,9
ENT.CXD-450-12,5	●		12,5		3x66	16	85x255	185x290x270	-25°C+55°C	6	9,6
ENT.CXD-450-15	●		15		3x79	19,2	90x255	185x290x270	-25°C+55°C	6	10,8
ENT.CXD-450-20	●		20		3x104	25,7	100x255	225x340x270	-25°C+55°C	6	13,2
ENT.CXD-450-25	●		25		3x131	32,1	116x255	330x340x225	-25°C+55°C	4	11,9
ENT.CXD-450-30	●		30		3x157	38,5	116x290	330x340x225	-25°C+55°C	4	13,4
ENT.CXD-450-40	●		40		3x219	52,5	116x370	270x270x452	-25°C+55°C	4	15
ENT.CXD-450-50	●		50		3x274	65,6	125x370	270x270x453	-25°C+55°C	4	16
ENT.CXD-550-2,5	●			2,3	3x8,5	2,6	65x165	195x390x255	-25°C+55°C	14	5,4
ENT.CXD-550-5	●			4,6	3x17	5,2	75x165	195x390x255	-25°C+55°C	6	5,4
ENT.CXD-550-7,5	●			6,8	3x25	7,9	75x255	185x290x270	-25°C+55°C	6	7,9
ENT.CXD-525-10	●			10	3x38	12,1	85x255	185x290x270	-25°C+55°C	6	7,9
ENT.CXD-525-12,5	●			12,5	3x48	15	85x255	185x290x270	-25°C+55°C	6	9,6
ENT.CXD-525-15	●			15	3x58	18,2	100x255	225x340x270	-25°C+55°C	6	10,8
ENT.CXD-525-20	●			20	3x77	24,2	116x255	330x340x225	-25°C+55°C	4	13,2
ENT.CXD-525-25	●			25	3x96	30,2	116x255	330x340x225	-25°C+55°C	4	11,9
ENT.CXD-525-30	●			30	3x115	36,3	116x290	330x340x225	-25°C+55°C	4	13,4
ENT.CXD-525-40	●			40	3x154	44	116x370	270x270x454	-25°C+55°C	4	15
ENT.CXD-525-50	●			50	3x192	55	125x370	270x270x455	-25°C+55°C	4	16

Please contact us for 60Hz capacitors.



## Discharge Unit



# DU-3 Discharge Unit

The DU-3 Discharge Unit discharges the capacitors that go on and off quickly, extending the lifetime of the capacitors and preventing internal heat losses.

Features	DU-3
<b>Electrical Characteristics</b>	
Coil Resistance	3000 Ω
Operating Period	Continuous
Nominal Voltage	230 ... 460 VAC
Nominal Frequency	50 Hz
The Number of Phase	3
LV Capacitor Power to be Discharged	5...50 kVAr
Losses	< 1 W
<b>Mechanical Features</b>	
Ambient Temperature	Maximum 40°C
Protection Class	IP20
Dimensions	PK21
Weight	0,4 kg
Product Quantity in 1 Box	20

	Continuous Current (mA)		
	230V	400V	500V
U	1	4	8
V	2	6	12
W	1	4	8

Reactive Power Q (kVAr)	Discharge Time (sec)		
	230	400	450
10	4	2	2
20	8	3,5	3
25	10	4	4
30	12	5,5	5
50	20	8	6

### Connection Diagram

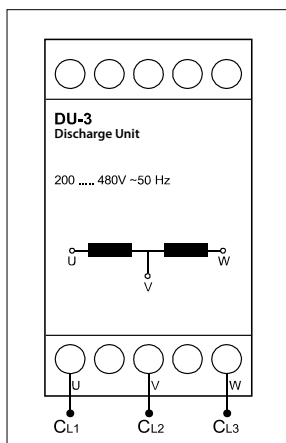

### Dimensions

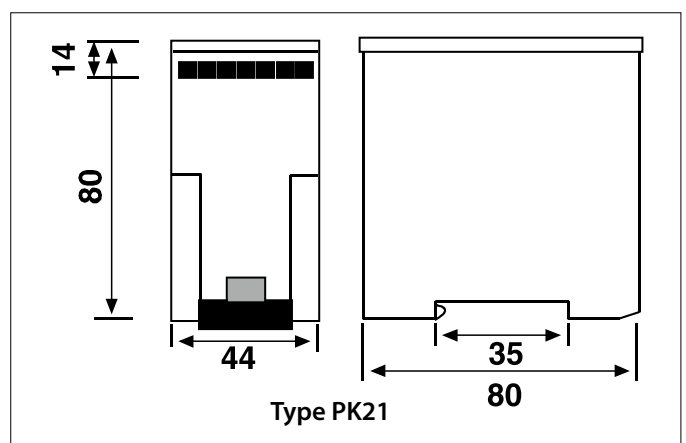

## Shunt Reactors (Inductive Load Reactor)



# ENT.SRS Series

Shunt Reactors; Designed for compensation of capacitive energy used by long underground power lines, UPSs, computers, electronic ballast and energy saving lamps. ENTES Shunt Reactors are designed in European standards, long-lasting and resistant to harsh operating conditions. All of the reactors designed to meet the inductive load requirement are CE marked.

### Features;

- Single or three phase, high permeability, air gap design
- F insulation class insulation material with 155°C resistance in windings
- Design in accordance with customer specifications
- Thermal protection against overload
- Vacuum impregnated varnish method, which increases efficiency by reducing heat losses, provides protection against moisture and silent operation.
- CE marked Compatible with EN 61558 2-20

**Compensate capacitive reactive power in each phase with ENTES SVC Shunt Reactors.**



### Benefit

Compensation is ensured based on required power characteristics with ENTES SVC Shunt Reactors. While balanced loads are compensated with three phase shunt reactors, imbalanced loads require single phase shunt reactors for each phase for the best performance.

# Compensation

## ENT.SRS Series

### Single Phase Shunt Reactors

Product Name	kVAr	L (mH)	I <sub>rms</sub> (A)	Operating Voltage	Dimension	Drawing	Weight (kg)
ENT.SRS1 230/0,1	0,1	1684	0,436	230V 50Hz	1	1	1,4
ENT.SRS1 230/0,25	0,25	674	1,09	230V 50Hz	2	1	2,4
ENT.SRS1 230/0,5	0,5	338	2,17	230V 50Hz	3	1	3,1
ENT.SRS1 230/0,3/0,4/0,5	0,3-0,4-0,5	338-421-560	1,30-1,74-2,17	230V 50Hz	7	1	3,7
ENT.SRS1 230/1	1	168	4,34	230V 50Hz	4	1	6,8
ENT.SRS1 230/1,5	1,5	112	6,53	230V 50Hz	5	1	9,2
ENT.SRS1.230/1,66	1,66	101	7,22	230V 50Hz	8	1	9,2
ENT.SRS1 230/2	2	84	8,7	230V 50Hz	9	1	12,5
ENT.SRS1 230/2,5	2,5	67	10,9	230V 50Hz	6	1	15,8
ENT.SRS1 230/3	3	57	12,83	230V 50Hz	9	1	15,95
ENT.SRS1.230/3,33	3,33	51	14,48	230V 50Hz	9	1	19,2
ENT.SRS1 230/5	5	33,7	21,74	230V 50Hz	10	2	20,2
ENT.SRS1.230/6,67	6,67	25,3	29	230V 50Hz	10	2	22,5
ENT.SRS1 230/7,5	7,5	22,4	32,6	230V 50Hz	11	2	25,6
ENT.SRS1.230/10	10	16,8	43,48	230V 50Hz	11	2	28,5

Dimension	A	B	C	D	E
1	84	74	87	70	57
2	96	185	98	80	66
3	120	107	115	100	88
4	150	122	145	125	98
5	150	122	145	125	98
6	192	125	185	160	95
7	120	107	115	100	88
8	150	123	145	125	100
9	192	163	187	140	133
10	240	125	305	120	105
11	240	145	305	120	125

Drawing 1

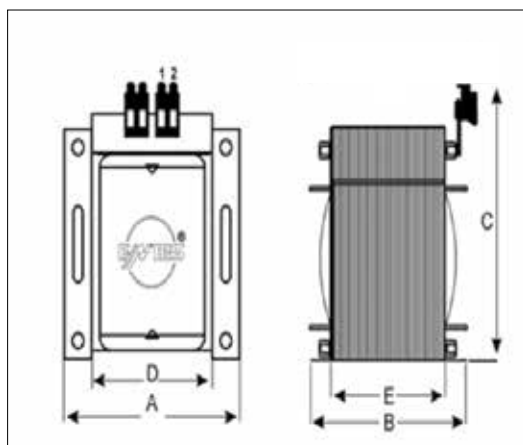

Drawing 2

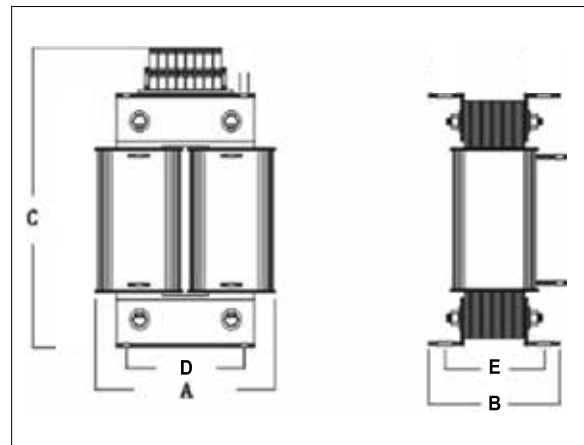

### Three Phase Shunt Reactors

Product Name	kVAr	(mH)	(A)	Operating Voltage	Dimension	Weight (kg)
ENT.SRS3 400/0,25	0,25	2040	0,36	400V 50Hz	1	2,3
ENT.SRS3 400/0,5	0,5	1020	0,72	400V 50Hz	2	3
ENT.SRS3 400/1	1	505	1,44	400V 50Hz	3	7,8
ENT.SRS3 400/1,5	1,5	336	2,17	400V 50Hz	4	9,5
ENT.SRS3 400/2	2	255	2,89	400V 50Hz	5	11,6
ENT.SRS3 400/2,5	2,5	203	3,61	400V 50Hz	6	11,9
ENT.SRS3 400/3	3	170	4,33	400V 50Hz	7	16,7
ENT.SRS3 400/5	5	102	7,22	400V 50Hz	8	22,5
ENT.SRS3 400/7,5	7,5	68	10,83	400V 50Hz	9	32
ENT.SRS3 400/10	10	51	14,43	400V 50Hz	10	44
ENT.SRS3 400/15	15	34	21,65	400V 50Hz	11	53
ENT.SRS3 400/20	20	25,5	28,87	400V 50Hz	12	70,5
ENT.SRS3 400/25	25	20,4	36,09	400V 50Hz	13	94
ENT.SRS3 400/40	40	12,75	57,74	400V 50Hz	14	127

Dimension	A	B	C	D	E	F1	F2	G	H
1	120	68	102	100	53	12	7	125	75
2	150	63	127	125	48	12	7	150	70
3	180	93	152	150	77	12	7	175	100
4	180	103	152	150	87	12	7	175	110
5	240	93	203	200	87	12	7	225	210
6	240	103	203	200	87	12	7	225	220
7	240	103	203	200	87	12	7	225	220
8	300	125	253	250	105	17	9	275	145
9	300	135	255	250	115	17	9	275	155
10	360	136	305	300	112	17	9	305	200
11	420	146	355	350	122	20	13	355	260
12	420	166	355	350	142	20	13	355	260
13	480	166	405	400	136	20	13	405	260
14	480	206	405	400	176	20	13	405	300

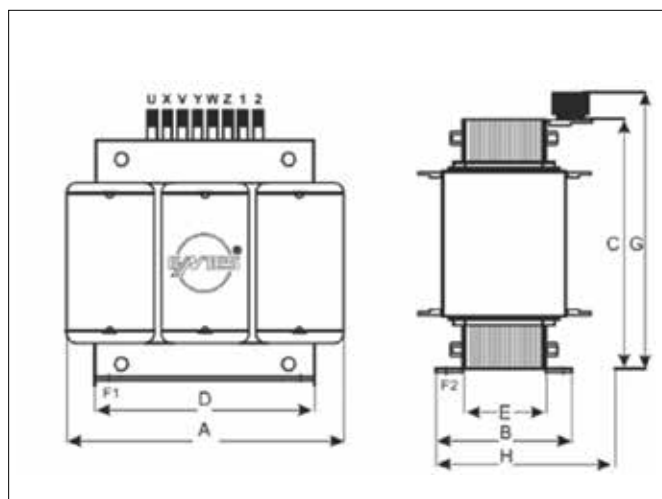



## Harmonic Filter Reactors

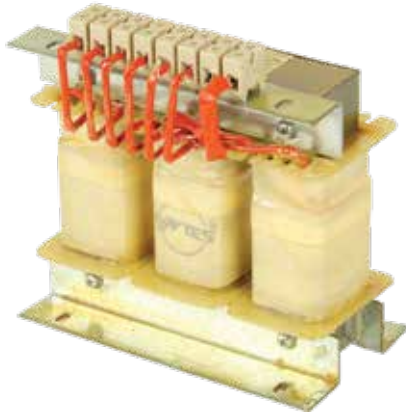

# ENT.ERH Series

ENTES Harmonic Filter Reactors are high quality reactors designed to protect the compensation system by absorbing harmonics in reactive power control systems.

With the use of harmonic filters, the currents passing through the capacitors are reduced by creating an additional impedance to the capacitor impedance at harmonic frequencies (such as the 5th harmonic 250 Hz and the 7th harmonic 350 Hz).

When the capacitor is switched on, the heating of the capacitor decreases as the currents flowing through the capacitor will decrease at harmonic frequencies.

The high currents that occur while the capacitor groups are activated are prevented.

Possible overload risk is eliminated due to resonance.

Capacitor life is extended since the possibility of heating and insulation rupture is reduced.

Since harmonics will decrease throughout the enterprise, it helps to protect sensitive devices such as computers, medical systems, PLC from the disruptive effects created by harmonics.

### Features:

Air-gapped design that minimizes body grounding resistance

High magnetic permeability iron core

Vacuum impregnated varnish method, which increases efficiency by reducing heat losses, provides protection against moisture and provides silent operation.

Thermal protection switch in the middle coil against overload and overheating

CE marked, compliant with EN 61000-2-2 and EN 61558 2-20

## Harmonic Filter Reactor Selection

For the selection of the harmonic filter reactor, first of all, harmonic (THDV and THDI) measurements should be made at different times and under different load conditions while the Compensation system is turned off.

fr=P factor	THDV	THDI
%5,67	< %2	>%25
%7	All other situations	
%14	>%4	<%15

fr=P factor	Resonance Frequency for 50Hz	C Min. Voltage Value
%5,67	210Hz	424V
%7	189Hz	430V
%14	134Hz	465V

# Harmonic Filter Reactors

## Single Phase Harmonic Filter Reactors

**Harmonic Filter Reactor Selection Chart**  
**230V 50Hz, 189Hz Resonance Frequency (p=7%)**

Type	kVAr	L (mH)	I <sub>rms</sub> (A)	I <sub>th</sub> (A)	I <sub>lin</sub> (A)	C* (uF)	Dimension	Weight (kg)	Appropriate Capacitor
ENT.ERH-E50 7-230-0,28	0,28	45,35	1,22	1,342	2,5	15,65	1	0,75	ENT.CF-230-0,26
ENT.ERH-E50 7-230-0,6	0,6	21,35	2,58	2,838	5,2	33,24	2	0,95	ENT.CF-400-1,67
ENT.ERH-E50 7-230-0,9	0,9	14,26	3,86	4,246	8,6	49,76	3	1,4	ENT.CF-400-2,50
ENT.ERH-E50 7-230-1,5	1,5	8,554	6,44	7,084	15,4	83	4	2	ENT.CF-400-4,17
ENT.ERH-E50 7-230-3	3	4,282	12,87	14,157	26,4	165,8	5	2,9	ENT.CF-400-8,33
ENT.ERH-E50 7-230-4,44	4,44	2,854	19,32	21,252	39,6	248,8	6	3,7	ENT.CF-400-4,17 +ENT.CF-400-8,33
ENT.ERH-E50 7-230-5,40	5,4	2,359	23,37	25,707	47,8	301	7	3,95	ENT.CF-230-5
ENT.ERH-E50 7-230-10,75	10,75	1,179	46,75	51,425	95,6	602	8	6,5	ENT.CF-230-10

Dimension	A	B	C	D	E	F
1	66	66	50	63	50	80
2	66	66	50	65	52	80
3	84	84	64	76	64	85
4	84	84	64	99	87	85
5	96	96	84	102	86	95
6	108	120	90	122	104	115
7	120	120	90	130	112	115
8	150	130	100	121	95	160

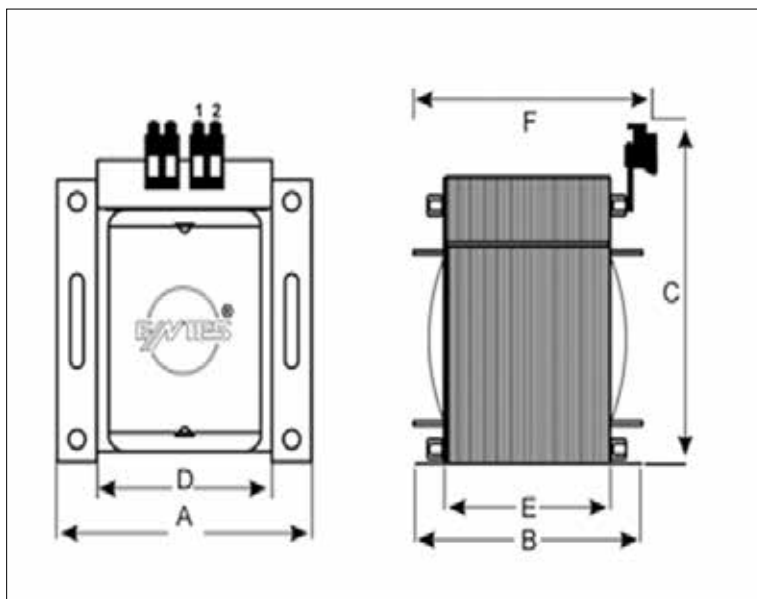

## Harmonic Filter Reactors

### Three Phase Harmonic Filter Reactors

#### Harmonic Filter Reactor Selection Chart

400V 50Hz, 210Hz Resonance Frequency ( $p=5.67\%$ )

ENT.ERH-E50	kVAr	L (mH)	I <sub>rms</sub> (A)	I <sub>th</sub> (A)	I <sub>in</sub> (A)	C* (uF)	Dimension	Weight (kg)	Appropriate Capacitor
ENT.ERH-5,67-400-4	4	7,65	7,02	7,72	15,92	25,02	0	4	ENT.CXD-450-5
ENT.ERH-5,67-400-5	5	6,12	8,77	9,65	19,90	31,28	0	4,5	ENT.CXD-450-5+ENT.CXD-450-1
ENT.ERH-5,67-400-6,25	6,25	4,90	10,97	12,06	24,87	39,1	0	5	ENT.CXD-450-7,5
ENT.ERH-5,67-400-7,5	7,5	4,08	13,16	14,48	29,85	46,92	1	7	ENT.CXD-450-7,5+ENT.CMD-450-1,5
ENT.ERH-5,67-400-10	10	3,06	16,8	18,48	35,13	62,55	13	6,5	ENT.CXD-450-12,5
ENT.ERH-5,67-400-12,5	12,5	2,45	21	23,1	43,91	78,19	19	8	ENT.CXD-450-15
ENT.ERH-5,67-400-16,6	16,6	1,84	27,88	30,67	58,32	103,84	15	9,9	ENT.CXD-450-20
ENT.ERH-5,67-400-20	20	1,53	33,6	36,95	70,26	125,11	4	12,2	ENT.CXD-450-25
ENT.ERH-5,67-400-25	25	1,53	38,11	41,92	73,52	154,18	5	15,2	ENT.CXD-450-30
ENT.ERH-5,67-400-30	30	1,02	50,39	55,43	105,39	187,66	6	16,9	ENT.CXD-450-15+ENT.CXD-450-20
ENT.ERH-5,67-400-40	40	0,77	67,19	73,91	140,53	250,22	16	18,7	ENT.CXD-450-25 2 pcs
ENT.ERH-5,67-400-50	50	0,61	83,99	92,39	175,66	312,77	18	26,9	ENT.CXD-450-30 2 pcs
ENT.ERH-5,67-400-60	60	0,51	100,79	110,86	210,79	375,33	10	38,9	ENT.CXD-450-25 3 pcs
ENT.ERH-5,67-400-80	80	0,38	134,38	147,82	281,05	500,44	10	42,3	ENT.CXD-450-25 4 pcs
ENT.ERH-5,67-400-100	100	0,31	167,98	184,77	351,31	625,55	10	48,6	ENT.CXD-450-30 4 pcs

400V 50Hz, 189Hz Resonance Frequency ( $p=7\%$ )

ENT.ERH-E50	kVAr	L (mH)	I <sub>rms</sub> (A)	I <sub>th</sub> (A)	I <sub>in</sub> (A)	C* (uF)	Dimension	Weight (kg)	Appropriate Capacitor
ENT.ERH-7-400-2,5	2,5	15,3	4	4,4	8,4	15	0	4	ENT.CXD-450-1,5 2 pcs
ENT.ERH-7-400-4	4	9,58	6,4	7	13,4	24,7	0	4,5	ENT.CXD-450-5
ENT.ERH-7-400-5	7,6	7,67	8	8,85	1	30,8	0	5	ENT.CXD-450-5+ENT.CMD-450-1
ENT.ERH-7-400-6,25	6,25	6,12	10,4	11,05	20,97	39,30	1	7	ENT.CXD-450-7,5
ENT.ERH-7-400-7,5	7,5	5,11	12,05	13,26	25,16	47,16	1	7	ENT.CXD-450-7,5+ENT.CMD-450-1,5
ENT.ERH-7-400-10	10	3,83	15,24	16,77	29,41	61,67	19	8,1	ENT.CXD-450-12,5
ENT.ERH-7-400-12,5	12,5	3,07	19,06	20,96	36,76	77,09	3	9,3	ENT.CXD-450-15
ENT.ERH-7-400-16,6	16,6	2,31	25,31	27,84	48,82	102,38	4	11,4	ENT.CXD-450-20
ENT.ERH-7-400-20	22,2	1,92	30,49	33,54	58,82	123,35	4	12,2	ENT.CXD-450-25
ENT.ERH-7-400-25	25	1,53	38,11	41,92	73,52	154,18	5	15,2	ENT.CXD-450-30
ENT.ERH-7-400-30	30	1,28	45,73	50,31	88,23	185,02	6	16,9	ENT.CXD-450-15+ENT.CXD-450-20
ENT.ERH-7-400-40	40	0,96	60,98	67,07	117,64	246,69	16	18,7	ENT.CXD-450-25 2 pcs
ENT.ERH-7-400-50	50	0,77	76,22	93,84	147,05	308,36	18	26,9	ENT.CXD-450-30 2 pcs
ENT.ERH-7-400-60	60	0,64	91,47	100,61	176,46	370,04	10	38,9	ENT.CXD-450-25 3 pcs
ENT.ERH-7-400-80	80	0,48	121,95	134,15	235,28	493,38	10	42,3	ENT.CXD-450-25 4 pcs
ENT.ERH-7-400-100	100	0,38	152,44	167,69	294,1	616,73	10	48,6	ENT.CXD-450-30 4 pcs

# Harmonic Filter Reactors

## 400V 50Hz, 134Hz Resonance Frequency ( $p=14$ )

ENT.ERH-E50	kVAr	L (mH)	I <sub>rms</sub> (A)	I <sub>th</sub> (A)	I <sub>lin</sub> (A)	C* (uF)	Dimension	Weight (kg)	Appropriate Capacitor
ENT.ERH-14-400-5	5	16,58	7,69	8,46	14,03	28,52	1	6,5	ENT.CXD-525-7,5
ENT.ERH-14-400-6,25	6,25	13,27	9,62	10,58	17,54	35,64	2	7,5	ENT.CXD-525-10
ENT.ERH-14-400-7,5	7,5	11,05	11,54	12,69	21,05	42,77	2	9	ENT.CXD-550-7,5+ENT.CXD-550-5
ENT.ERH-14-400-10	10	8,29	14,52	15,98	24,38	57,3	3	9,6	ENT.CXD-525-15
ENT.ERH-14-400-12,5	12,5	6,63	18,15	19,97	30,48	71,29	4	11,7	ENT.CXD-525-20
ENT.ERH-14-400-16,6	16,6	4,99	24,11	26,52	40,47	94,67	4	12,2	ENT.CXD-525-25
ENT.ERH-14-400-20	20	4,15	29,05	31,95	48,76	114,06	5	15,4	ENT.CXD-525-30
ENT.ERH-14-400-22,4	22,4	3,7	32,53	35,79	54,61	134,68	6	17,6	ENT.CXD-525-20+ENT.CXD-525-15
ENT.ERH-14-400-25	25	3,32	36,31	39,94	60,95	144,09	7	26,3	ENT.CXD-525-25+ENT.CXD-525-12,5
ENT.ERH-14-400-30	30	2,76	43,57	47,93	73,14	171,09	7	26,8	ENT.CXD-525-20+ENT.CXD-525-25
ENT.ERH-14-400-40	40	2,07	58,09	63,9	97,52	228,12	8	29,9	CXD-525-30 2 pcs
ENT.ERH-14-400-44,4	44,4	1,87	64,49	70,93	108,25	253,22	8	31,8	ENT.CXD-525-30+ENT.CXD-525-25+ENT.CXD-525-12,5
ENT.ERH-14-400-50	50	1,66	72,62	79,88	121,9	285,15	9	31,8	CXD-525-25 3 pcs
ENT.ERH-14-400-60	60	1,38	87,14	95,86	146,29	342,18	10	41	CXD-525-30 3 pcs
ENT.ERH-14-400-80	80	1,04	116,19	127,81	195,05	456,24	11	48,6	CXD-525-30 4 pcs
ENT.ERH-14-400-100	100	0,83	145,24	159,76	243,81	570,31	12	61,2	CXD-525-30 5 pcs

Dimension	A	E	H	B	C	D
0	120	100	120	45	-	-
1	150	-	160	105	110	56
2	180	-	270	120	185	78
3	180	160	-	155	135	97
4	240	210	-	140	185	79
5	240	210	-	150	185	89
6	240	210	-	160	185	99
7	264	248	-	190	200	121
8	300	260	-	185	224	116
9	300	260	-	190	224	121
10	360	310	-	205	265	126
11	360	310	-	215	265	138
12	360	310	-	235	265	156
13	180	160	-	135	135	178
14	180	160	-	145	135	88
15	180	-	185	120	135	97
16	240	210	-	165	185	104
17	264	248	-	170	200	101
18	300	260	-	180	224	111
19	180	160	-	145	135	88,5
20	180	160	-	145	135	97
21	240	210	-	160	185	99
22	240	210	-	160	200	106
23	264	250	-	155	200	106
24	264	250	-	170	200	121
25	300	365	-	185	224	116
26	300	310	-	195	265	126

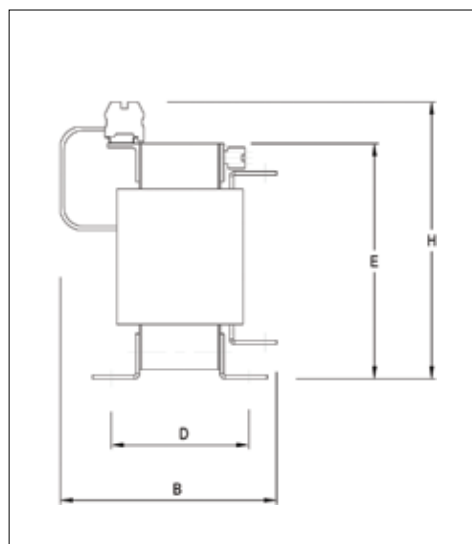
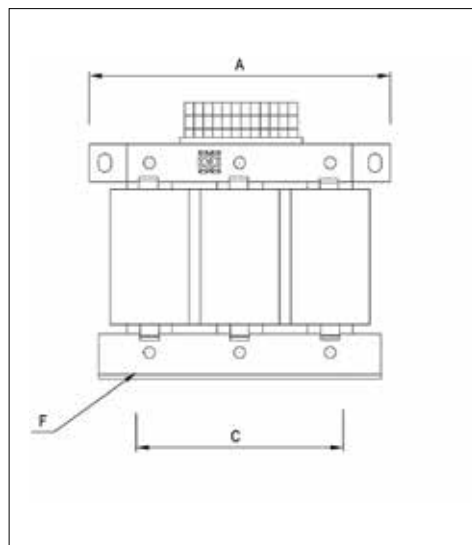

## Compensation Contactors



## ENT-KT Series

ENT-KT Compensation Contactors are double-step contactors specially designed to prevent high inrush currents. With the ENT-KT auxiliary contact block, it transmits the inrush currents over the damping resistors and ensures that the overcurrents remain within acceptable limits. (In 2.5 and 5kVAr models, resistance to overcurrents is provided by a reinforced special contact alloy.)

### Features;

Auxiliary contact block

Three-phase connection

Possibility to connect capacitors up to 60 kVAr

Coil voltage: 220-230 VAC 50/60 Hz conforming to IEC-947

Long electrical life

UL certified (12,16,20 and 25kVAr models)

Can be given as UL certified in exported panels (12,16,20 and 25kVAr models)

### With these features of ENT-KT Compensation Contactors:

- Contact life is extended
- Reactive penalty risk due to contactor failures (compensation error) is reduced. Capacitor failures are reduced.
- Energy quality is improved by preventing voltage fluctuations
- As the maintenance period of the compensation system will be longer and unexpected failure situations will decrease, the production losses of the enterprises will decrease.

# Compensation Contactors

## ENT-KT Series

Type	Operating Power(kVar)		Instant Auxiliary Contacts		Max Number of Operations per hour	Number of Switching Life Applications
	0 < 55°C	50/60 Hz	NO	NC		
	200V 240V	400V 440V				
ENT-KT-2,5-C10	1,4	2,5	1	0	240	150.000
ENT-KT-5-C10	2,8	5	1	0	240	150.000
ENT-KT-7,5-C11	4,0	7,5	1	1	240	200.000
ENT-KT-12-C11	6,7	12,5	1	1	240	200.000
ENT-KT-16-C11	8,5	16,7	1	1	240	200.000
ENT-KT-20-C11	10,0	20,0	1	1	240	100.000
ENT-KT-25-C11	15,0	25,0	1	1	240	100.000
ENT-KT-33-C12	20,0	33,3	1	2	240	100.000
ENT-KT-40-C12	25,0	40,0	1	2	240	100.000
ENT-KT-60-C12	40,0	60,0	1	2	240	100.000
ENT-KT-75-C12	45,0	75,0	1	2	240	100.000

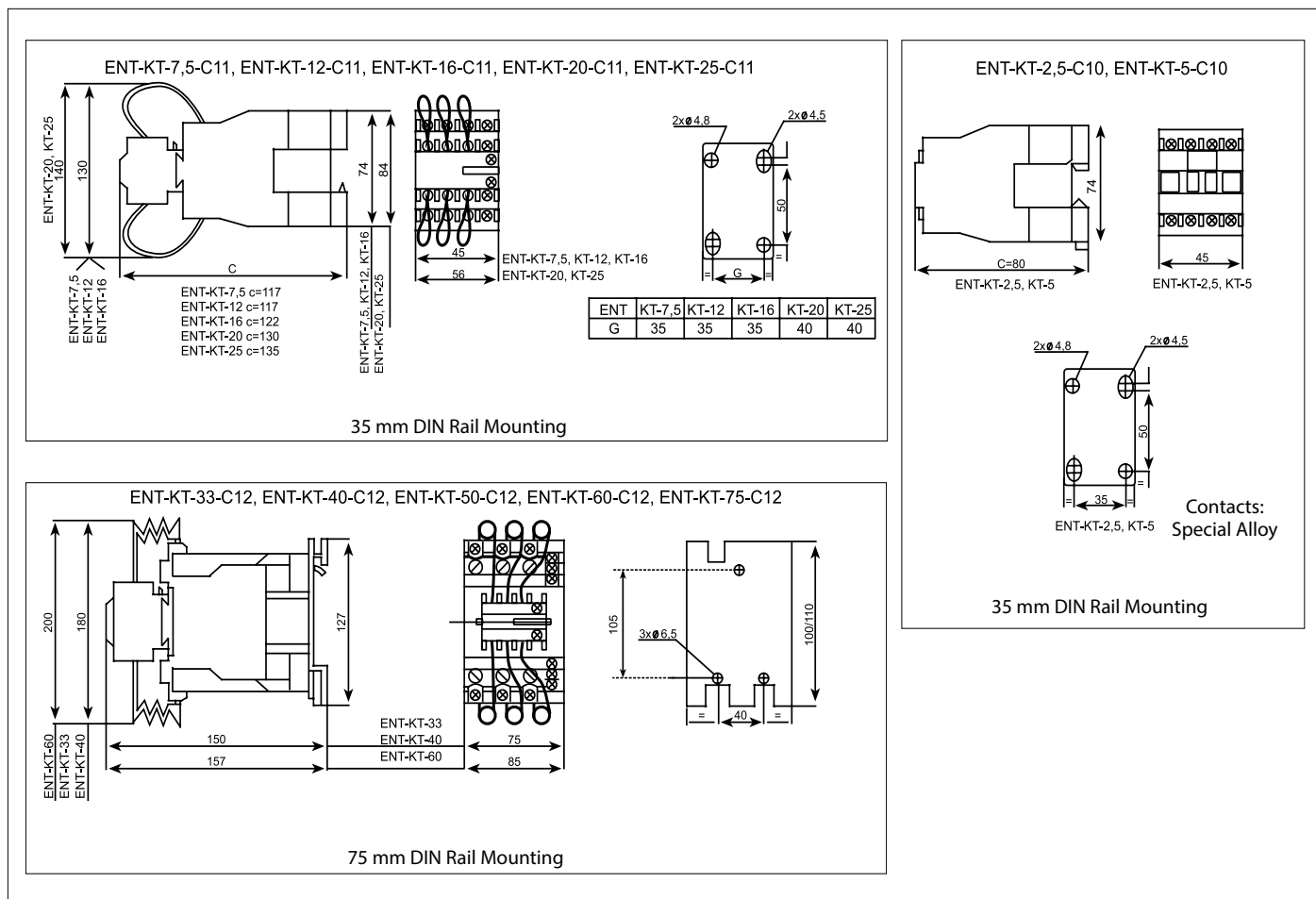

## Fuse Switch Disconnecters



# AYR Series Fuse Switch Disconnecter

It provides protection function when used together with NH Fuses with load disconnecter. 160 and 250 A models are available. Used with NH00 and NH1 NH fuses.

### Features;

- Compact Dimension
- Compatible With NH00 and NH1 Fuses
- AC-23B Usage Category
- 50/60 Hz Rated Frequency
- IEC620269-2

### PARAMETERS

#### AYR.160

NH00 / NH00C	Nominal Operating Voltage	Ue	V	400 VAC	690 VAC
	Nominal Operating Current	Ie	A	160	100
	Thermal Current	Ith	A	160	100
	Nominal Short-Circuit Current		kA	100	50
	Insulation Voltage	Ui	V	800	
	Nominal Impulse Voltage	Uimp	kV	8	
	Electrical Endurance		Electrical Shock	200	

#### AYR.250

NH1	Nominal Operating Voltage	Ue	V	400 VAC	690 VAC
	Nominal Operating Current	Ie	A	250	200
	Thermal Current	Ith	A	250	200
	Nominal Short-Circuit Current		kA	100	50
	Insulation Voltage	Ui	V	800	
	Nominal Impulse Voltage	Uimp	kV	8	
	Electrical Endurance		Electrical Shock	200	

AYR.160

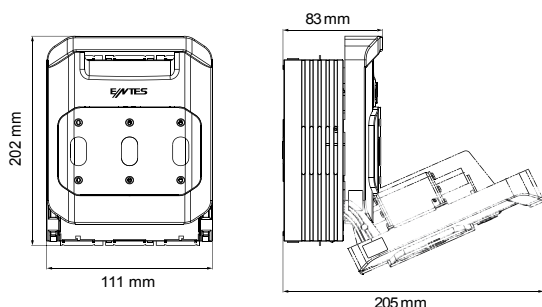

AYR.250

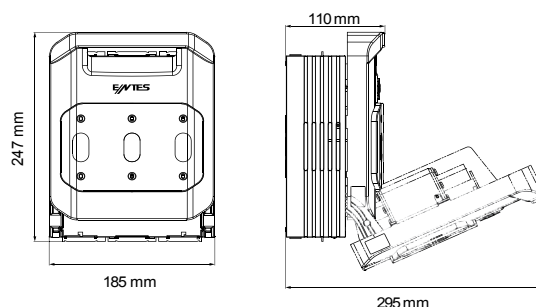



# NH Knife Fuses

Model	Product Description	Length	Nominal Current In(A)	Nominal Short Circuit Breaking Capacity kA (500V)	Nominal Voltage(V)
ENT.NH00 20A	20A NH Knife Fuses	NH00	20	120	500
ENT.NH00 25A	25A NH Knife Fuses		25		
ENT.NH00 40A	40A NH Knife Fuses		40		
ENT.NH00 50A	50A NH Knife Fuses		50		
ENT.NH00 63A	63A NH Knife Fuses		63		
ENT.NH00 80A	80A NH Knife Fuses		80		
ENT.NH00 100A	100A NH Knife Fuses		100		
ENT.NH00 125A	125A NH Knife Fuses		125		
ENT.NH00 160A	160A NH Knife Fuses		160		
ENT.NH1 125A	125A NH Knife Fuses	NH1	125	120	500
ENT.NH1 160A	160A NH Knife Fuses		160		
ENT.NH1 200A	200A NH Knife Fuses		200		
ENT.NH1 250A	260A NH Knife Fuses		250		

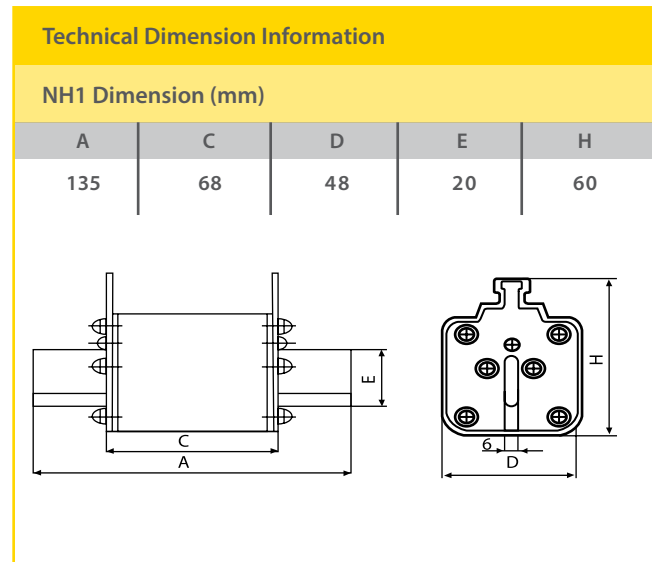
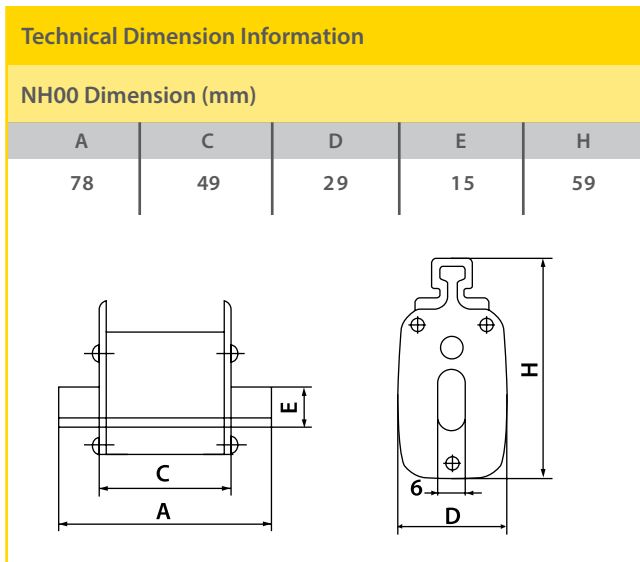



## Static Contactors



# SC Series Static Contactors

SC Series Static Contactors are used in systems with inductive loads that switch on and off quickly. By using SC Series Static Contactors, capacitors that will provide capacitive power to the system can be switched on and off within 1 period (20ms). Thus, the compensation of the loads that come in and out in a short time such as spot welding machines, cranes, arc furnaces can be done effectively.

- Response time less than 20ms / Reactor thermal input Thermal protection / Easy Mounting of Warning LEDs
- Quiet operation / triggering with RS-485 or DC voltage
- Ability to trigger in case the capacitor voltage is greater than the maximum voltage
- Cooler design that allows continuous operation at maximum temperature and load
- Frequency 45-65 Hz / Trigger 5-30 VDC / Operating Temperature -10 C°, + 55C°
- Storage Temperature -10C°, +75C° Humidity 95%
- Protection Class IP-00 Standard EN 60947-1 / Dimensions; 276mm x 150mm x 212mm for SC350/325
- 273.7 x 119 x 168 mm for SC250/225

Product Name	Maximum Capacitor Power (3-Phase)	Maximum Capacitor Power (1-Phase)	Switching Time (Max.)	RS-485	Operating Frequency	Nominal Operating Current	Nominal-Max. Operating Voltage
SC-225	25kVAr		20ms		45-65Hz	36A	400-480 VAC (L-L)
SC-225S	25kVAr		20ms	●	45-65Hz	36A	400-480 VAC (L-L)
SC-250	50kVAr		20ms		45-65Hz	72A	400-480 VAC (L-L)
SC-250S	50kVAr		20ms	●	45-65Hz	72A	400-480 VAC (L-L)
SC-325	25kVAr	8,33kVAr	20ms		45-65Hz	36A	400-690 VAC (L-L)
SC-350	50kVAr	16,66kVAr	20ms		45-65Hz	72A	400-690 VAC (L-L)

\*This product is recommended to be used with ENTES SPD series surge voltage devices.

### STAR CONNECTION

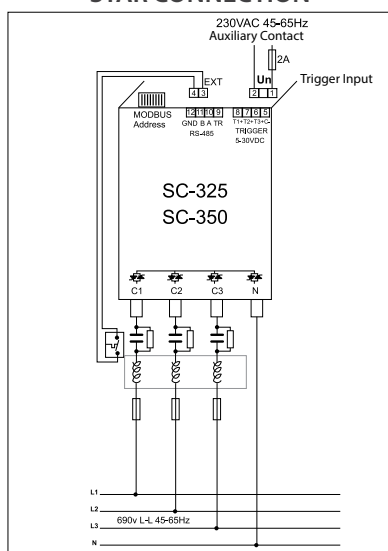

### DELTA CONNECTION

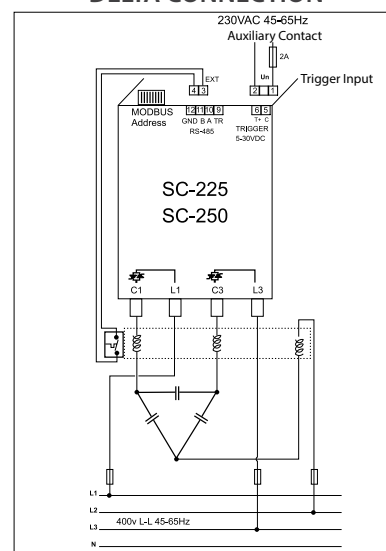

Surge Protection Device

# SPD Series Surge Protection Device

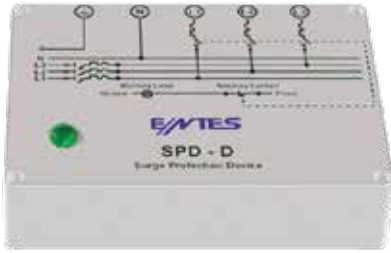

SPD Series Surge Protection Devices prevent devices from being damaged by taking the energy of these surge voltages in environments where high surge voltages threaten sensitive devices. Thus, service continuity is guaranteed and the repair costs of important devices in the system are reduced.

SPD-D Type Device provides protection against surge voltages that may occur between phase-neutral, neutral-ground and phase-phase, while SPD-S type protects against phase-neutral and neutral-ground.

Teknik Özellikler	25 kVAr	50 kVAr
UC	440 V~ (+10%) (Phase-Phase) 45 – 65 Hz	690 V~ (+10%) (Phase-Phase) 45 – 65 Hz
I <sub>max</sub>	40 kA	40 kA
I <sub>n</sub>	20 kA	20 kA
U <sub>p</sub>	1,3 kV	1,3 kV
Protecton Class	IP 20	IP 20
Dimensions(mm)	171*121*80	171*121*80
Weight(gr)	746	634
Operating Temperature(°C)	-10...55 °C	-10...55 °C
Storage Temperature(°C)	-10...70 °C	-10...70 °C
Package Number	1	1

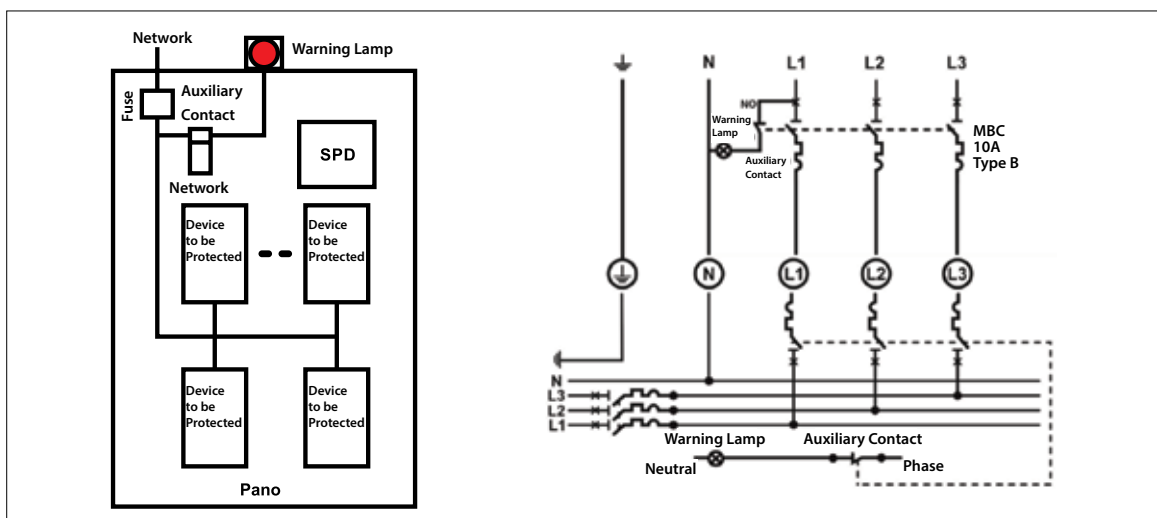

## LV Current Transformers



# ENT.A Series

Current Transformers are transformers with isolated windings that convert high primary currents to low secondary currents, used in applications where direct reading of the current is difficult or impossible.

The high current on the primary side is reduced on the secondary side, with this way it is preventing devices or measuring instruments from being affected by high voltage.

ENT.A Series Current Transformers are of two types according to their construction types;

**Wound Type Current Transformers:** In wound type current transformers, primary and secondary windings consist of windings on a magnetic core. (A Series)

**Busbar type current transformers:** The primary of the current transformer comes out from the side surfaces and is connected to the line conductor. (AB Series)

### Technical Features

Primary Current Range	5- 5000 A
Nominal Power Range	1,5-30 VA
Accuracy Class	Class 0.5/Class 1
Operating Frequency	50-60 Hz
Insulation Test Voltage	Ui= 3 kV eff, 1 min.
Maximum Operating Voltage	Um= 0,72 kV
Nominal Continuous Thermal Current	1,2 x Ipr
Nominal Thermal Short-Circuit Current	Ith=60 x Ipr
Thermal Class	B(130°C)
Over Current Factor	n<5
Enclosure Material	UL94 V-0 Plastic
Operating Temperature	-5 °C ... +40 °C
Standard	TS EN 61869-2 IEC 61869-2
Usage Type	Building/Inside Panel

## LV Current Transformers

Type	Secondary Current		5A			
	Primary Current(A)	Nominal Power(VA)	Class			
			3	1	0,5	
ENT.A20 MN	40	1	●			
	50	1,25		●		
	60	1,25		●		
	75	1,5		●		
	100	1,5				●
		2,5		●		
	125	2				●
		4		●		
	150	2,5				●
		5		●		
	200	2,5				●
		5		●		
	250	5				●
		7,5		●		

Type	Secondary Current		5A			1A		
	Primary Current(A)	Nominal Power(VA)	Class					
			3	1	0,5	3	1	0,5
ENT.A30 MN	40	1	●					
	50	1		●				
	60	1						●
		1,5		●				
	75	1,25						●
		1,5		●				
	80	1,5						●
		2,5		●				
	100	1,5				●		
		2,5		●	●		●	
	125	1,5				●		
		2,5		●				●
	150	2,5		●				●
		2,5				●		
	200	2,5			●			●
	250	2,5				●		
		5						●
	300	5			●			●
	400	5			●			
	500	5			●			
600	5			●			●	

## LV Current Transformers

Type	Secondary Current		5A			1A		
	Primary Current(A)	Nominal Power(VA)	Class					
			3	1	0,5	3	1	0,5
ENT.A40 MN	100	1						●
		1,5		●				
	125	2						
		1,5		●				●
	150	2,5		●				
		1,5						●
	200	2,5			●			
		1,5						●
	250	2,5			●			
		1,5						●
	300	2,5						●
		5			●			
	400	5			●			●
	500	5			●			●
	600	5			●			

Type	Secondary Current		5A			
	Primary Current(A)	Nominal Power(VA)	Class			
			1	0,5	0,2	0,25
ENT.AB	15	2,5				●
		10		●		
	20	2,5				●
		10		●		
	30	2,5				●
		10		●		
	50	2,5				●
		10		●		
	60	2,5				●
		10		●		
	75	2,5				
		10		●		●
	80	10		●		
	100	2,5				●
		10		●		●
	125	10		●		
150	2,5				●	
	10		●			

## LV Current Transformers

Type	Secondary Current		5A					1A							
	Primary Current(A)	Nominal Power(VA)	Class												
			3	1	0,5	0,2	0,2S	3	1	0,5	0,2	0,2S			
ENT.A30	30	1	●									●			
	40	1										●			
		1,5		●											
	50	1										●			
		2,5		●											
	60	1										●			
		2,5		●											
	75	1,25										●			
		2,5		●											
	80	1,5										●			
		2,5		●											
	100	2,5										●			
		5		●											
	125	2,5										●			
		5		●											
	150	2,5											●		
		5		●	●										
	200	2,5											●		
		10			●										
	250	5											●		
		10			●										
	300	2,5					●								
		5										●			
		10			●										
	400	5					●								
		10			●										
	500	5													
		7,5					●								
10				●											
600	7,5														
	10			●	●										

## LV Current Transformers

Type	Secondary Current		5A				1A			
	Primary Current(A)	Nominal Power(VA)	Class							
			1	0,5	0,2	0,2S	1	0,5	0,2	0,2S
ENT.A40	75	1					●			
	80	1					●			
	100	1,25					●			
	125	2,5					●			
	150	2,5					●			
	200	2,5						●		
	250	2,5						●		
	300	2,5						●		
		10		●						
	400	5			●			●		
		10		●						
	500	5			●			●		
		10		●						
	600	5				●		●		
		10		●	●					
	750	7,5				●				
	10			●						
800	10			●	●					

Type	Secondary Current		5A		
	Primary Current(A)	Nominal Power(VA)	Class		
			0,5	0,2	0,2S
ENT. A60	600	10	●		
	750	5		●	
		7,5		●	
	800	10	●		
		7,5		●	
	1000	10	●		
		15	●	●	●
	1200	10	●		
		15	●	●	
	1250	10	●		●
15		●	●		

Type	Secondary Current		5A			
	Primary Current(A)	Nominal Power(VA)	Class			
			1	0,5	0,2	0,2S
ENT. A80	1000	10		●	●	
	1200	10		●	●	
	1250	10		●	●	
	1500	10		●		●
		15		●		
		30		●		
	1600	15		●		
		30		●		
2000	15		●			
	30		●			

## LV Current Transformers

Type	Secondary Current		5A			
	Primary Current(A)	Nominal Power(VA)	Class			
			1	0,5	0,2	0,2S
ENT. A100	2000	15		●		
		30		●		
	2500	15		●		
		30		●		
	3000	15		●		
		30		●		
	3200	15		●		
		30		●		
4000	30		●			
5000	30		●			

Type	Secondary Current		5A			
	Primary Current(A)	Nominal Power(VA)	Class			
			1	0,5	0,2	0,2S
A60T	500	5		●		
	600	5		●		
	750	5		●		
	800	10		●		
	1000	10		●		
	1200	10		●		
	1250	10		●		
	1600	15		●		
2000	15		●			

Type	Secondary Current		5A			
	Primary Current(A)	Nominal Power(VA)	Class			
			1	0,5	0,2	0,2S
A80T	600	10		●		
	800	10		●		
	1000	10		●		
	1200	10		●		
	1250	10		●		
	1500	15		●		
	1600	15		●		
	2000	15		●		
2500	15		●			

Type	Secondary Current		5A			
	Primary Current(A)	Nominal Power(VA)	Class			
			1	0,5	0,2	0,2S
A100T	1000	10		●		
	1500	15		●		
	1600	15		●		
	2000	15		●		
	2500	15		●		
	3000	15		●		
	3200	15		●		
	4000	30		●		



## LV Current Transformers

Type	Secondary Current		5A			
	Primary Current(A)	Nominal Power(VA)	Class			
			1	0,5	0,2	0,2S
ENT.A125T (Sekonder 5A)	2000	15 / 30		●		
	2500	15 / 30		●		
	3000	15 / 30		●		
	3200	15 / 30		●		
	4000	15 / 30		●		
	5000	15 / 30		●		
	6000	15 / 30		●		



## ENS Series LV Current Transformers

Split Core Current Transformers are easily installed in systems that are already in operation, without separating the busbar or conductors.

Operating Temperature  $-5^{\circ}\text{C}/+50^{\circ}\text{C}$

Storage Temperature  $-25^{\circ}\text{C}/+70^{\circ}\text{C}$

3 Phase Current Transformers; Thanks to the 35mm and 45mm busbar openings suitable for the standard busbar spacing of the switchgear manufacturers, it provides direct mounting to the switchgear outputs. This provides significant time savings in mounting time.

### Features

- Thermal Continuous Nominal Current  $I_{cth}: 1.2 \times I_n$  ( $1.0 \times I_n$  in ENS.AYS Series)
- Thermal Instantaneous Nominal Current  $I_{th} = 60 \times I_n$ , 1sec.
- Maximum Operating Voltage  $U_{m00.72}\text{kV}$
- Insulation Test Voltage  $3\text{kV}$ ,  $U_{eff}$ , 50Hz, 1min.
- Frequency: 50Hz
- Insulation Class: E
- Standards: TS EN 61869-2, VDE 0414-1

## LV Current Transformers

### ENS.AYS Series

#### Split- Core Current Transformers

Product Name	Primary Current(A)	Nominal Power (VA)	Class 3	Class 1	Class 0.5	Inner Dimension (mm)
ENS.AYS 23	100	1,25	●			20x30
ENS.AYS 23	150	1,5	●			20x30
ENS.AYS 23	200	2,5	●			20x30
ENS.AYS 23	300	3,75		●		20x30
ENS.AYS 58	400	2,5		●		50X80
ENS.AYS 58	500	5		●		50X80
ENS.AYS 58	600	5		●		50X80
ENS.AYS 58	800	7,5		●		50X80
ENS.AYS 58	1000	10		●		50X80
ENS.AYS 812	400	2,5		●		80X120
ENS.AYS 812	500-600-800	2,5			●	80X120
ENS.AYS 812	1000	5			●	80X120
ENS.AYS 816	1200	10			●	80X160
ENS.AYS 816	1500-1600-2000	15			●	80X160
ENS.AYS 816	2500-3000	15			●	80X160
ENS.AYS 816	4000	30			●	80X160
ENS.AYS 816	5000	15			●	80X160

### ENS.CYS Series

#### Split- Core Current Transformers

Product Name	Maximum Busbar Dimensions (mm)	Primary Current(A)	Secondary Current (A)	Nominal Power(VA)	Class 3	Class 1	Class 0,5
ENS.CYS 23	20x30	100	5	1,5	●		
	20x30	150-200	5	1,5		●	
	20x30	300	5	2,5		●	
ENS.CYS 58	50x80	400	5	2,5		●	
	50x80	500-600	5	5		●	
	50x80	800	5	7,5		●	
ENS.CYS 88	80X80	1000	5	5			●
ENS.CYS 812	80x120	400	5	1,5			●
	80x120	500-600-800	5	2,5			●
	80x120	1000	5	5			●
ENS.CYS 816	80x160	1200	5	10			●
	80x160	1500-1600 2000-2500 3000	5	15			●
	80x160	4000	5	30			●
	80x160	5000	5	15			●

## LV Current Transformers

### ENS.3PMD Series

#### Three Phase mV Output Current Transformer Series

Product Name	Primary Current(A)	Secondary(mV)	Class 1	Busbar Dimensions(mm)
<b>ENS.3PMD 25</b>				
ENS.3PMD 25 3X60	3x60	330	●	21 x 25
ENS.3PMD 25 3X75	3x75	330	●	21 x 25
ENS.3PMD 25 3X100	3x100	330	●	21 x 25
ENS.3PMD 25 3X150	3x150	330	●	21 x 25
ENS.3PMD 25 3X200	3x200	330	●	21 x 25
ENS.3PMD 25 3X250	3x250	330	●	21 x 25
<b>ENS.3PMD 33</b>				
ENS.3PMD 33 3X250	3x250	330	●	30,5 x 29,5
ENS.3PMD 33 3X330	3x300	330	●	30,5 x 29,5
ENS.3PMD 33 3X400	3x400	330	●	30,5 x 29,5
ENS.3PMD 33 3X500	3x500	330	●	30,5 x 29,5
ENS.3PMD 33 3X600	3x600	330	●	30,5 x 29,5
<b>ENS.3PM 55</b>				
ENS.3PMD 55 3X800	3x800	330	●	50,2 x 54
ENS.3PMD 55 3X1000	3x1000	330	●	50,2 x 54
ENS.3PMD 55 3X1250	3x1250	330	●	50,2 x 54
ENS.3PMD 55 3X1600	3x1600	330	●	50,2 x 54

### 3 Phase Current Transformers

Product Name	Primary Current(A)	Nominal Power (VA)	Class 1	Busbar Dimensions(mm)
<b>ENS.3PH 35</b>				
ENS.3PH 35 3X100/5A	3X100	1	1	Ø 35
ENS.3PH 35 3X150/5A	3X150	1,25	1	Ø 35
ENS.3PH 35 3X160/5A	3X160	1,5	1	Ø 35
ENS.3PH 35 3X200/5A	3X200	1,5	1	Ø 35
ENS.3PH 35 3X250/5A	3X250	2,5	1	Ø 35
<b>ENS.3PH 45</b>				
ENS.3PH 45 3X250/5A	3X250	2,5	1	Ø 45
ENS.3PH 45 3X300/5A	3X300	3,75	1	Ø 45
ENS.3PH 45 3X400/5A	3X400	5	1	Ø 45
ENS.3PH 45 3X500/5A	3X500	5	1	Ø 45
ENS.3PH 45 3X600/5A	3X600	5	1	Ø 45

## LV Clamp Type Current Transformers

# ENS.CCT Series



ENS.CCT Series current transformers provide the advantage of safe and easy use by giving the opportunities to assembly / disassembly without cutting the energy.

ENS.CCT Series, which offers advantages in energy monitoring installation in facilities where it is not possible to cut off the energy, can be used in narrow and small panel applications thanks to its lightweight and compact structure. They are preferred by mobile measurement teams for short-term measurement and test installations.

Model/Parameters	ENS.CCT-10	ENS.CCT-16	ENS.CCT-24	ENS.CCT-36
Rated Primary Current (In)	30A, 50A, 75A	100A, 120A	100A, 150A, 200A, 250A, 300A	400A, 500A, 600A
Secondary Value	333mV	333mV	333mV or 5A	333mV or 5A
Measurement Range	1A- In			
Max. Measurement Limit	1,2 In			
Measuring Accuracy	Class 1			
Operating Frequency	50/60 Hz			
Phase Shift	+ 1,5 ±1°	+ 1,0 ±1°	+ 0,5 ±0,5°	+ 0,5 ±0,5°
Max. Linear Deviation	-1 ± 1%	-1 ± 1%	-1 ± 1%	-1 ± 1%
Max. Operating Voltage / Insulation Class	0,72 / 3 kV	0,72 / 3 kV	0,72 / 3 kV	0,72 / 3 kV
Operating and Environmental Conditions	CAT III			
Storage Environmental Conditions	Temperature: -10 / -70 oC, Humidity ≤85%, Indoor			
ENS.3PH 30 3X600/5A	Temperature: -20 / -80 oC, Humidity ≤85%			

## Current Transformers



# CT Series

CT Series Current Transformers offer an economical solution for energy monitoring and electrical measurements with their compact design.

LV Current Transformer	Type	Compatible ENTES Products		
		Maximum Measurable Current		
 For ENTES Digital Measuring Devices	CT-25	80 A	120 A	210 A
		CT-80D (Only suitable for ES-80L)	ES-80L	
			MPR-53    EPM-04h MPR-53S    EPM-06 EPR-04    EPM-06C EPR-04S    EPM-06CS EPM-04    EPM-07 EPM-04C    EPM-07S EPM-04CS	EPM-4A EPM-4C EPM-R4C EPM-4P AKC-03

Technical Features	CT-25	CT-80D (Only suitable for ES-80L)
Cycle Rate	1/1500	1/1500
Inner Diameter	15.5 mm (70 mm <sup>2</sup> cable)	13 mm (35 mm <sup>2</sup> cable)
Outer Diameter	43	47,5
Primary Nominal Current	120 A (3-Phase measurement) 210 A (Single-Phase measurement)	80 A
Accuracy	Class 1	Class 1
Operating Temperature	-40 °C / +70 °C	-40 °C / +70 °C
Operating Frequency	50 Hz	50 Hz

\*CT-25 current transformer can only be used with CT-25 compatible versions of the models mentioned above. Please contact your sales representative for the compatibility of the model you have chosen.



**HEADQUARTERS: ENTES Elektronik Cihazlar İmalat ve Ticaret A.Ş.**

**Address:** Dudullu OSB; 1. Cadde; No: 23 34776 Umraniye - ISTANBUL / TÜRKİYE

**Tel:** +90 216 313 01 01 - **Sales Fax:** +90 216 365 71 71 - **Fax:** 0216 314 16 15 - **E-mail:** contact@entes.eu

**Web:** www.entes.eu - **Coordinates:** 40.996384, 29.175125

 [facebook.com/EntesElektronik](https://facebook.com/EntesElektronik)

 [linkedin.com/in/EntesElektronik](https://linkedin.com/in/EntesElektronik)

 [twittercom/EntesElektronik](https://twittercom/EntesElektronik)

 [youtube.com/EntesElektronik](https://youtube.com/EntesElektronik)